

US00D660211S

(12) **United States Design Patent**
Ikuma et al.

(10) **Patent No.:** **US D660,211 S**

(45) **Date of Patent:** **** May 22, 2012**

(54) **DOOR FOR AN AUTOMOBILE**

D601,072 S * 9/2009 Giachin D12/196
D633,839 S * 3/2011 Matei et al. D12/196

(75) Inventors: **Hirokazu Ikuma**, Toyota (JP); **Tatsuya Hotta**, Yokosuka (JP); **Tetsuya Nakagawa**, Yokosuka (JP)

* cited by examiner

(73) Assignee: **Toyota Jidosha Kabushiki Kaisha**,
Toyota-shi (JP)

Primary Examiner — Melody N Brown
(74) *Attorney, Agent, or Firm* — Finnegan, Henderson,
Farabow, Garrett & Dunner, LLP

(**) Term: **14 Years**

(57) **CLAIM**

The ornamental design for a door for an automobile, as shown and described.

(21) Appl. No.: **29/382,588**

DESCRIPTION

(22) Filed: **Jan. 5, 2011**

FIG. 1 is a front perspective view of a door for an automobile of our new design;

(51) **LOC (9) Cl.** **12-16**

FIG. 2 is a rear perspective view thereof;

(52) **U.S. Cl.** **D12/196**

FIG. 3 is a top plan view thereof;

(58) **Field of Classification Search** D12/196,

FIG. 4 is a bottom view thereof;

D12/90-92, 86; 296/181.1, 181.5

FIG. 5 is a left side view thereof;

See application file for complete search history.

FIG. 6 is a right side view thereof;

FIG. 7 is a front view thereof; and,

FIG. 8 is a rear view thereof.

Our design includes a mirror image of the embodiment depicted.

(56) **References Cited**

U.S. PATENT DOCUMENTS

D508,004 S * 8/2005 Metros et al. D12/196
D580,331 S * 11/2008 Gueler et al. D12/196

1 Claim, 6 Drawing Sheets

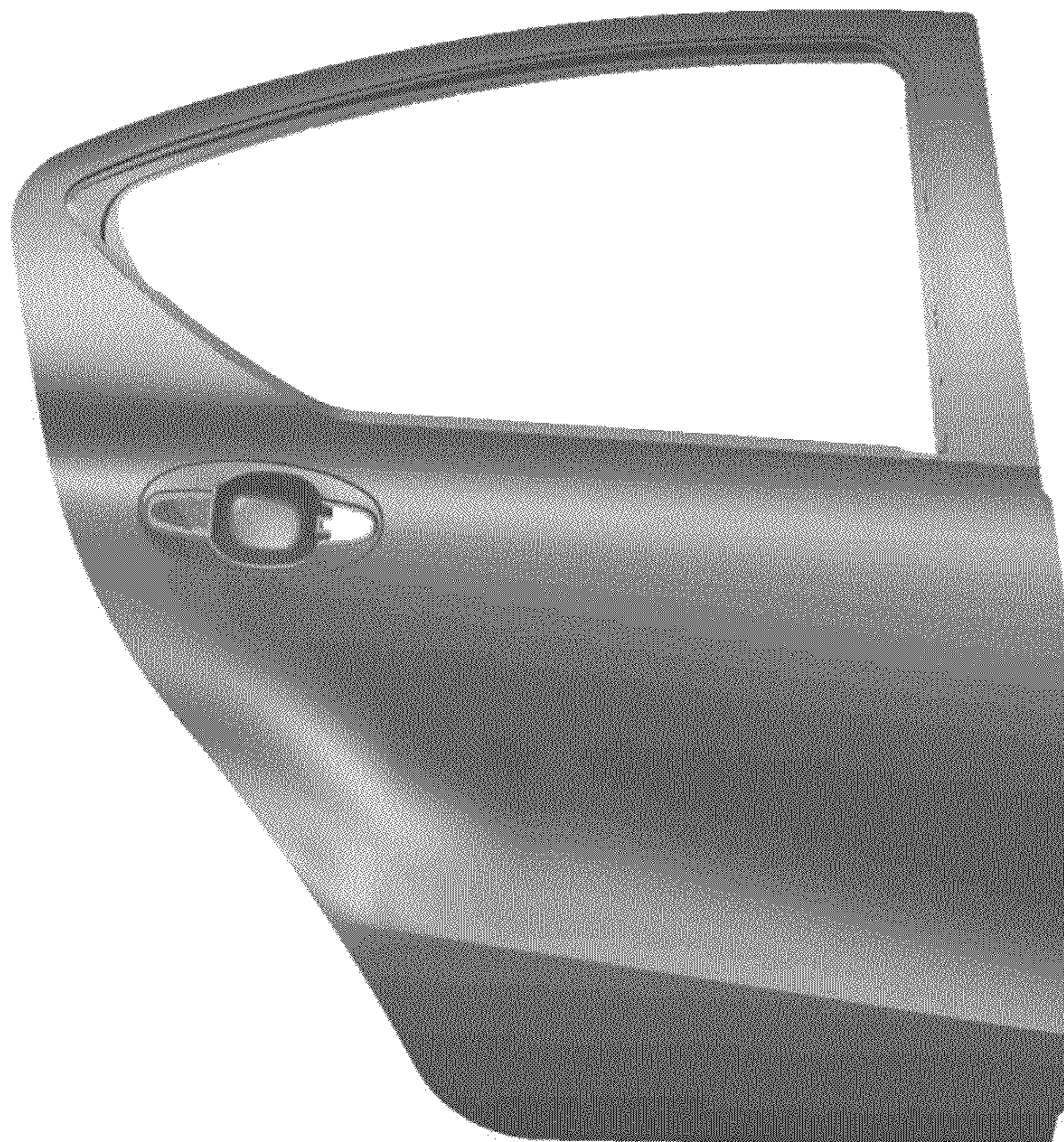

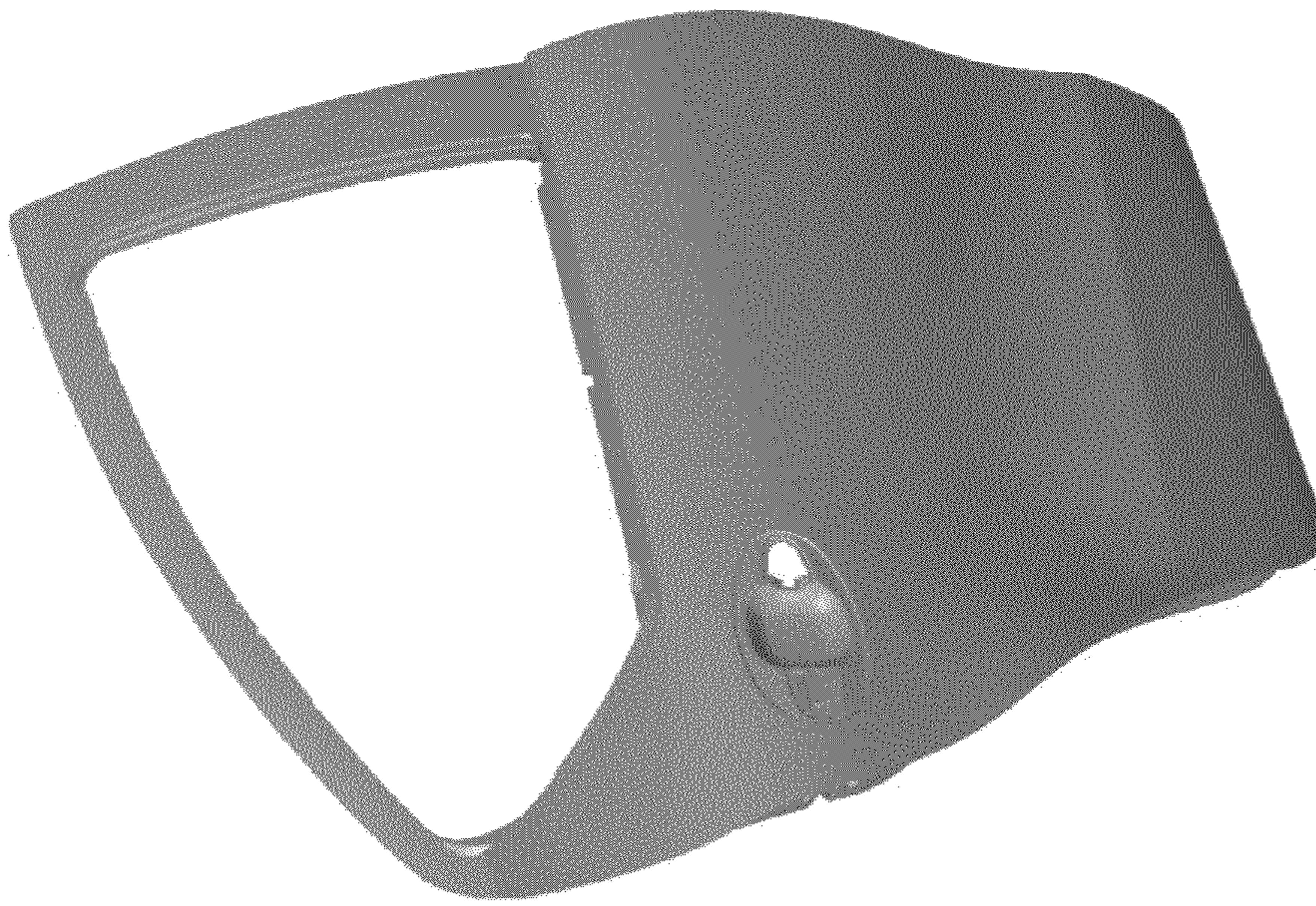

FIG. 1



FIG. 2

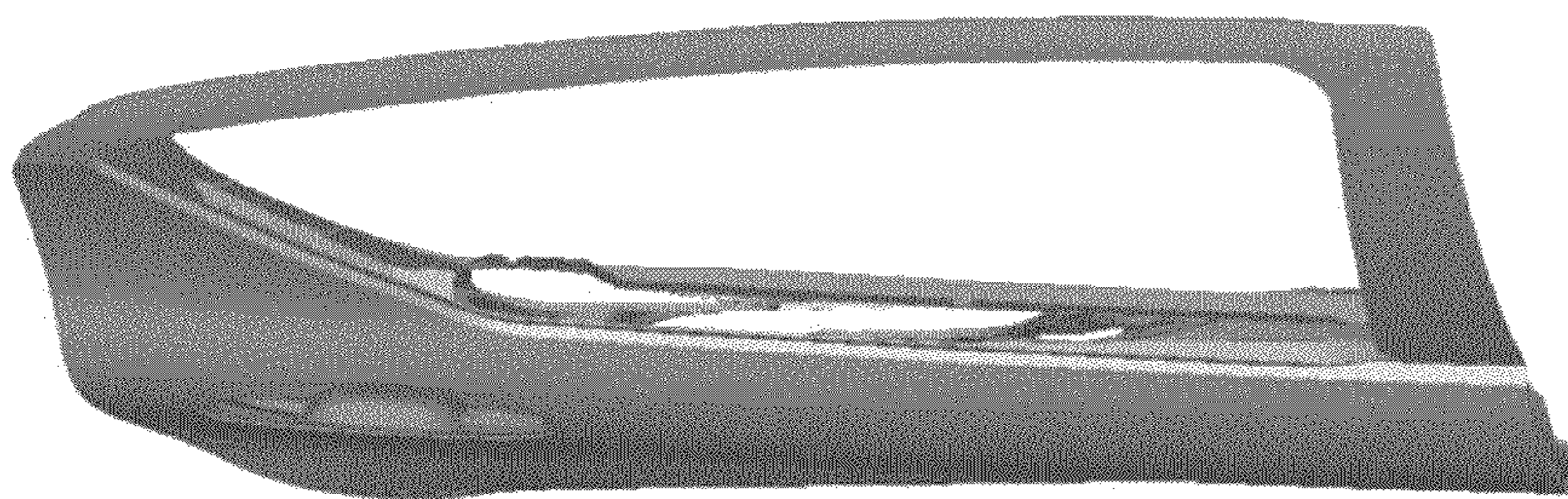

FIG. 3

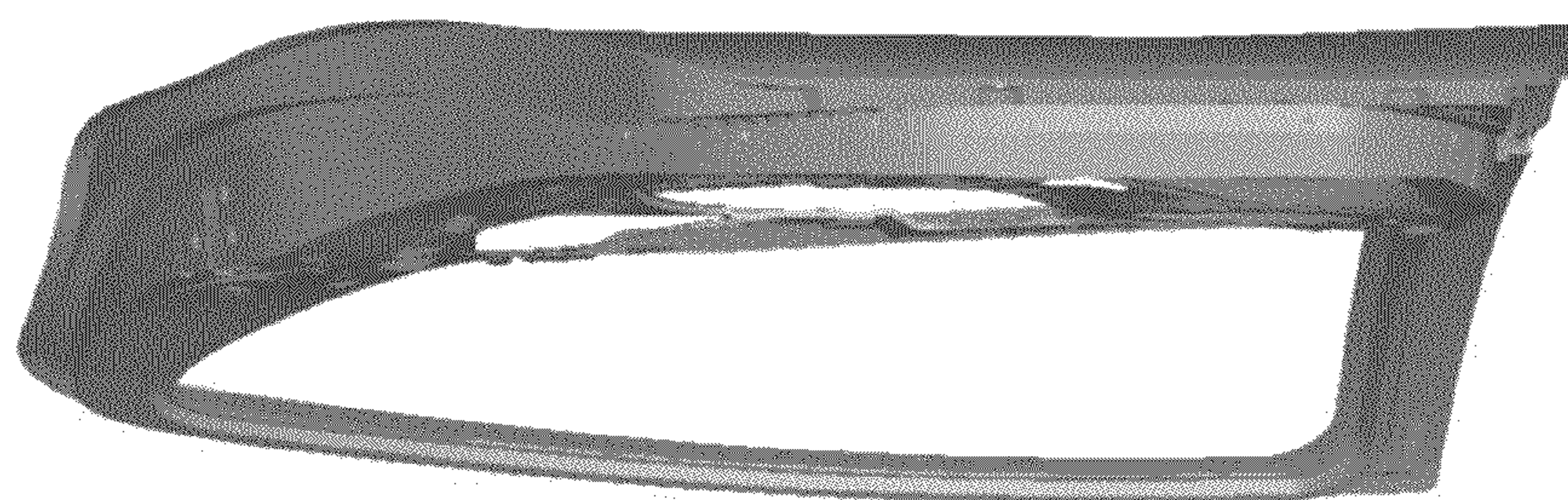

FIG. 4

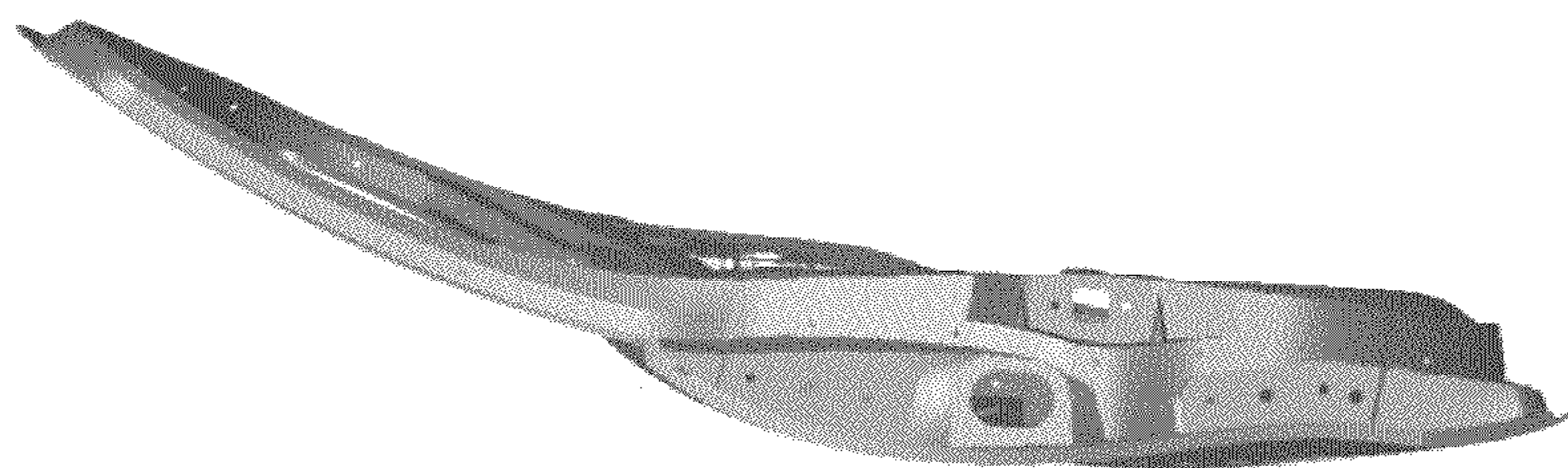

FIG. 6

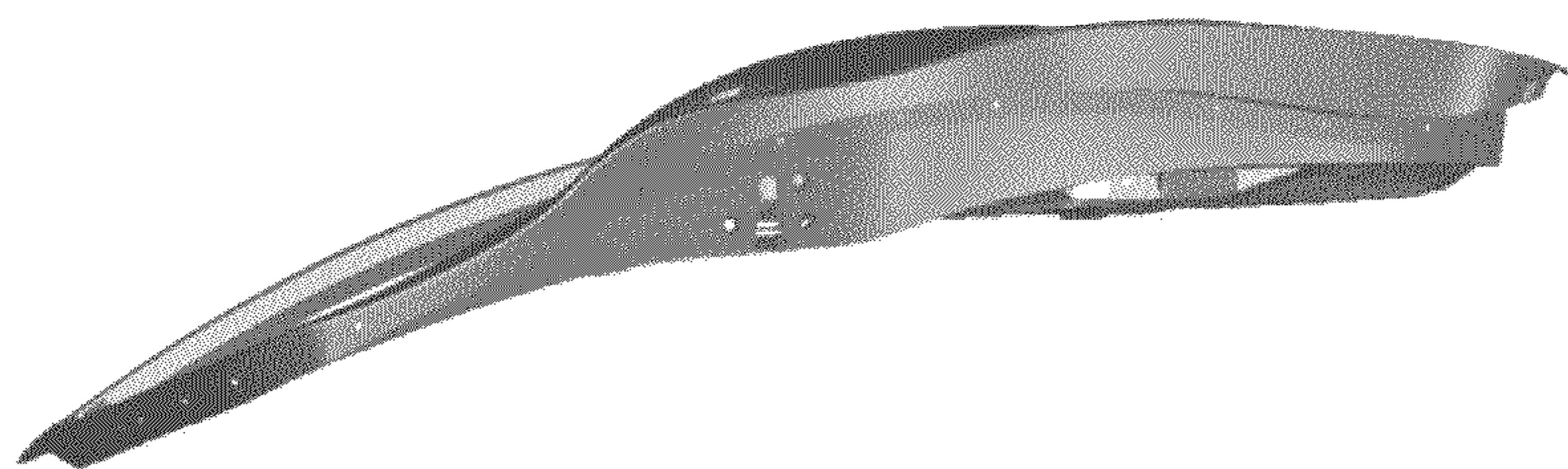

FIG. 5



FIG. 7

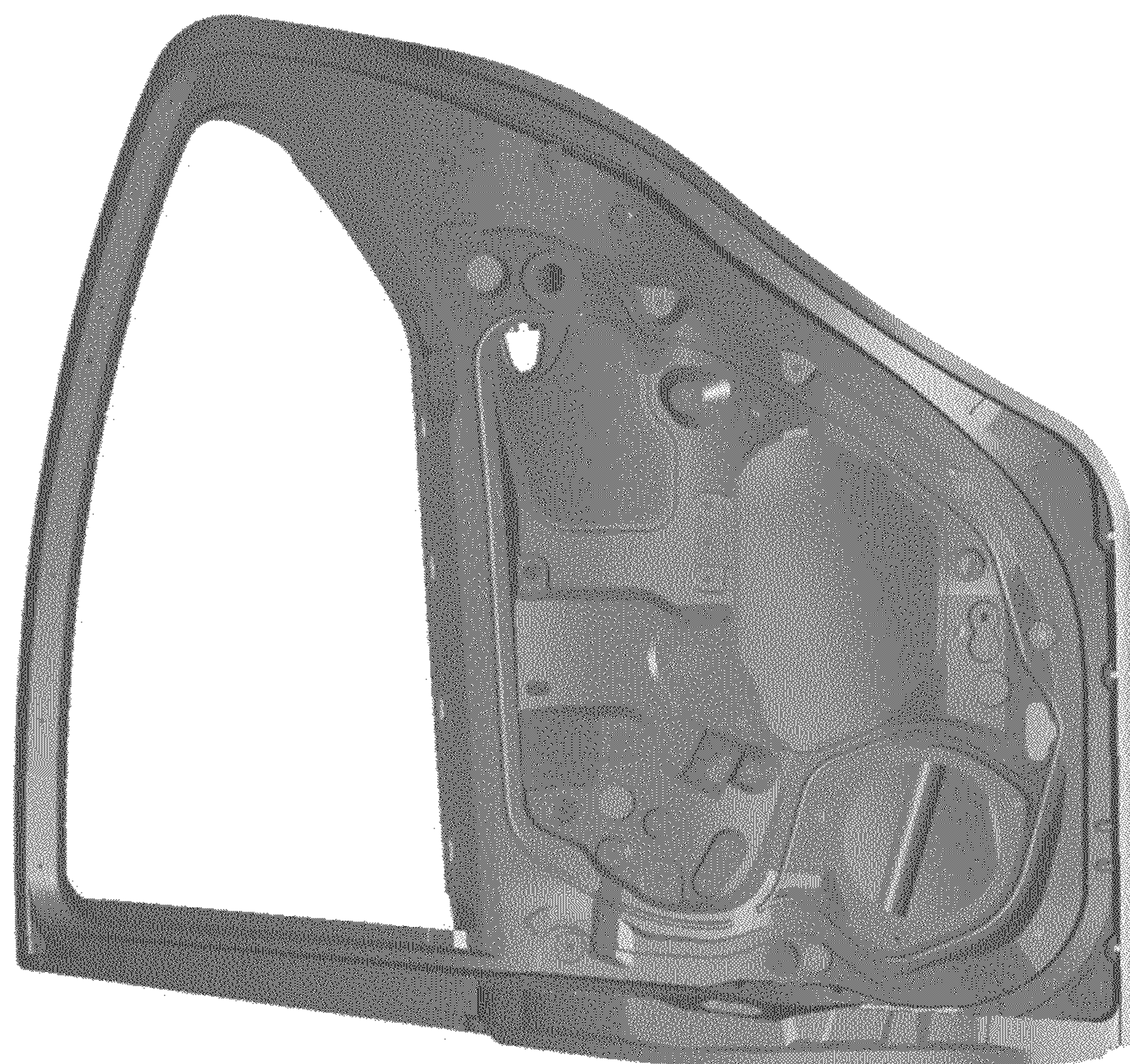

FIG. 8