



US00D660139S

(12) **United States Design Patent**
Gaudron et al.

(10) **Patent No.:** **US D660,139 S**
(45) **Date of Patent:** **** May 22, 2012**

- (54) **ANCHOR**
- (75) Inventors: **Paul Gaudron**, Stratford, CT (US);
Jacob Olsen, Roselle, IL (US)
- (73) Assignee: **Powers Products III, LLC**, Brewster,
NY (US)
- (**) Term: **14 Years**
- (21) Appl. No.: **29/375,778**
- (22) Filed: **Sep. 27, 2010**
- (51) **LOC (9) Cl.** **08-08**
- (52) **U.S. Cl.** **D8/385**
- (58) **Field of Classification Search** D8/385,
D8/386; 411/15, 80.1
See application file for complete search history.

- D462,895 S * 9/2002 Gaudron D8/385
 - 6,494,653 B2 * 12/2002 Remmers 411/344
 - 6,991,413 B2 * 1/2006 Ballou et al. 411/15
 - 7,001,124 B2 2/2006 Panasik et al.
 - D577,285 S * 9/2008 Gaudron D8/385
 - 2002/0150442 A1* 10/2002 Remmers 411/340
- * cited by examiner

Primary Examiner — Sheryl Lane
(74) *Attorney, Agent, or Firm* — Cantor Colburn LLP

(57) **CLAIM**
We claim, the ornamental design for an anchor, as shown and described.

DESCRIPTION

FIG. 1 is a perspective view of the anchor in a closed condition;
 FIG. 2 is a side view of the anchor in a closed condition, the opposite side being identical thereto;
 FIG. 3 is a front view of the anchor in a closed condition, the opposite side being identical thereto;
 FIG. 4 is a top view of the anchor in a closed condition;
 FIG. 5 is a bottom view of the anchor in a closed condition;
 FIG. 6 is a top perspective view of the anchor in an open condition;
 FIG. 7 is a bottom perspective view of the anchor in an open condition;
 FIG. 8 is a side view of the anchor in an open condition, the opposite side being a mirror image thereof;
 FIG. 9 is a top view of the anchor in an open condition,
 FIG. 10 is a bottom view of the anchor in an open condition;
 and,
 FIG. 11 is a side view of the anchor in an open condition, the opposite side being a mirror image thereof.

(56) **References Cited**

U.S. PATENT DOCUMENTS

D106,861	S	*	11/1937	Dellinger	D8/385
3,431,813	A		3/1969	Johnson		
3,461,772	A	*	8/1969	Barry	411/80.1
3,482,482	A	*	12/1969	Sage	411/80.1
4,022,100	A		5/1977	Johnson		
4,322,194	A		3/1982	Einhorn		
4,500,238	A		2/1985	Vassiliou		
4,662,808	A		5/1987	Camilleri		
4,669,936	A		6/1987	Camilleri		
4,752,170	A	*	6/1988	McSherry et al.	411/80.1
4,871,289	A		10/1989	Choiniere		
5,161,296	A	*	11/1992	Garfield et al.	29/524.1
5,224,805	A		7/1993	Moretti et al.		
5,791,845	A		8/1998	Fulop		

1 Claim, 3 Drawing Sheets

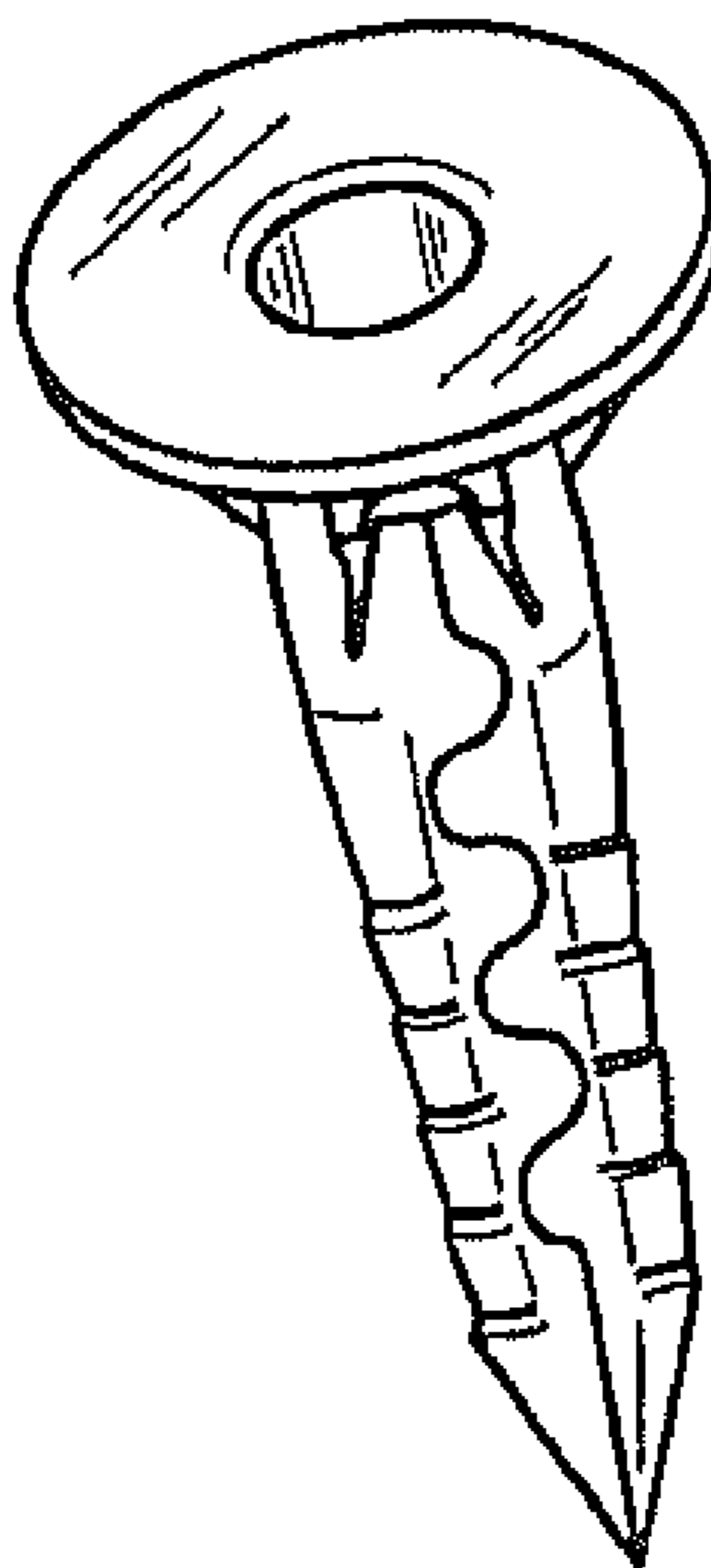

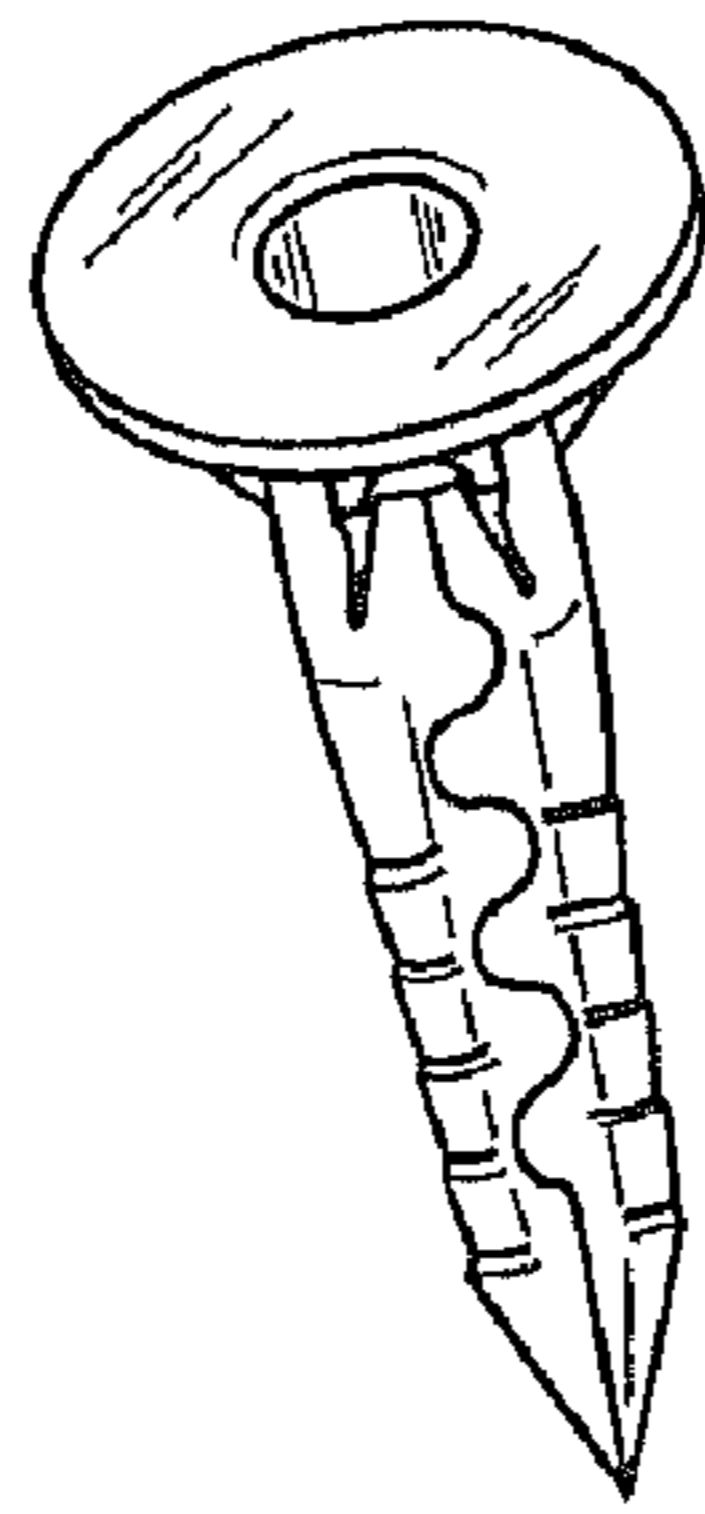

FIG. 1

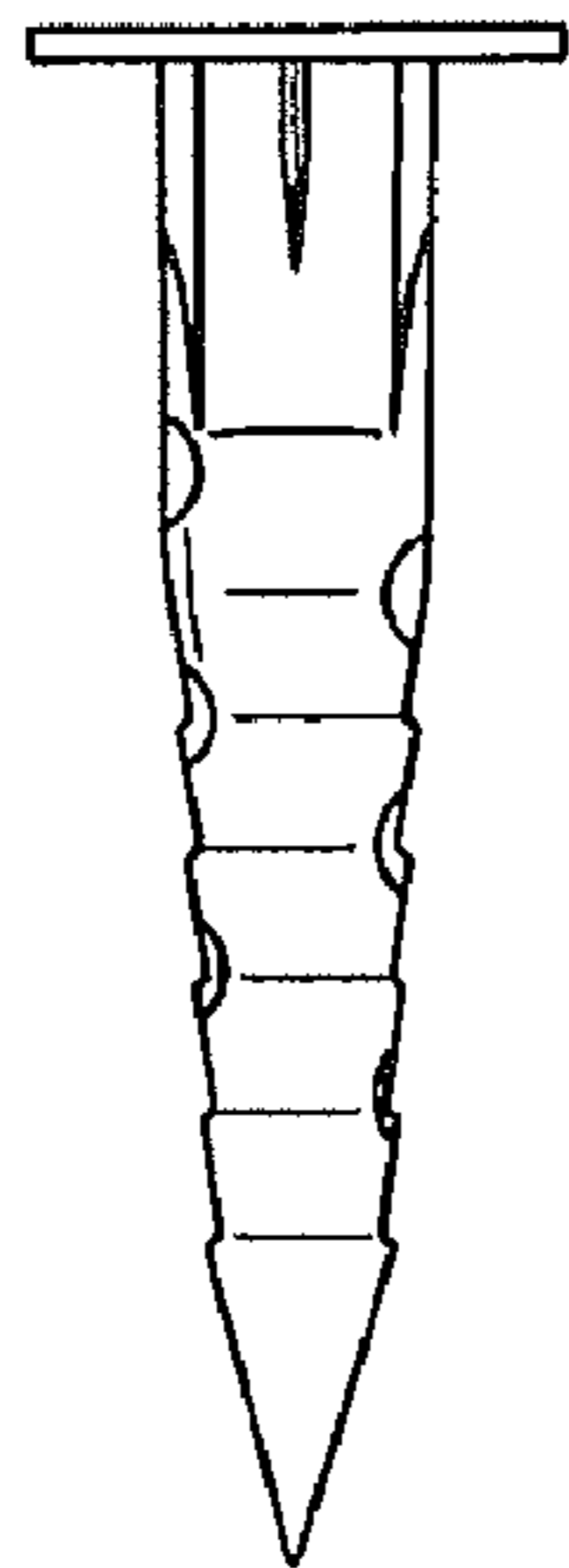

FIG. 2

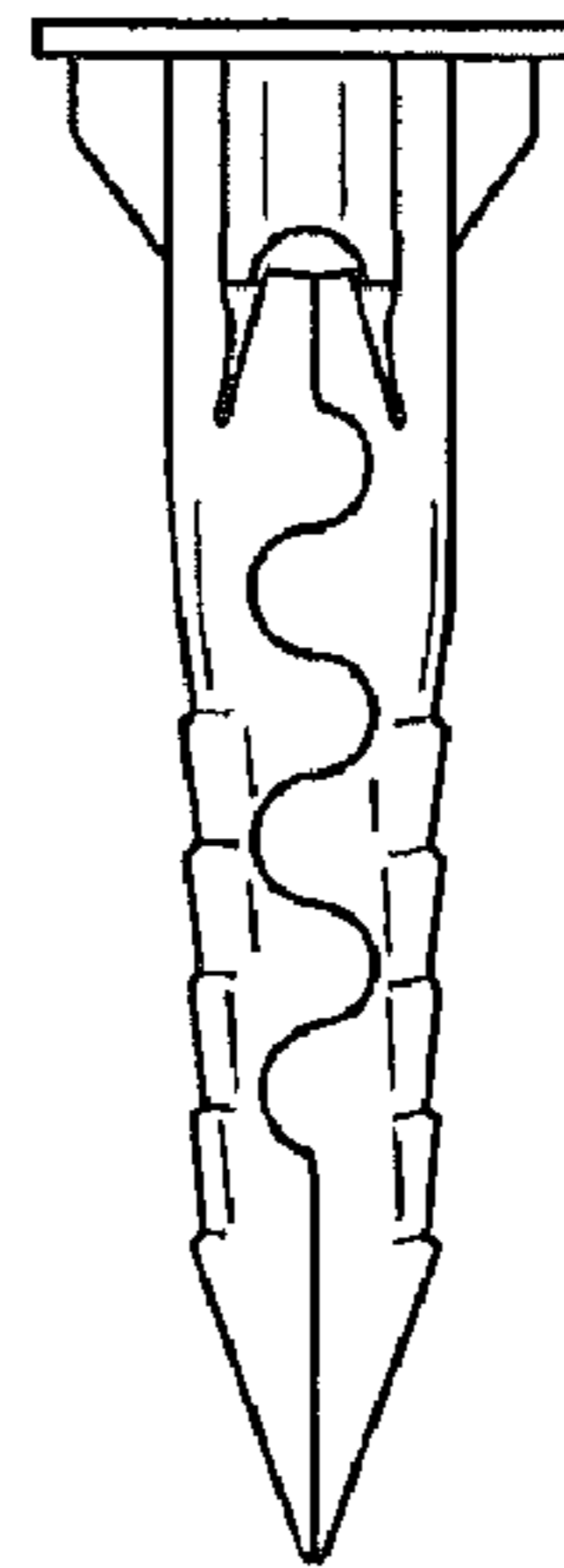

FIG. 3



FIG. 4

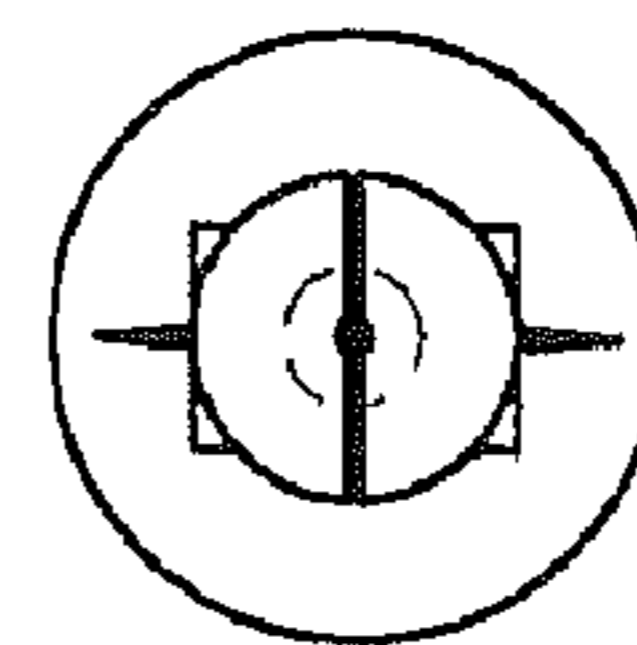

FIG. 5

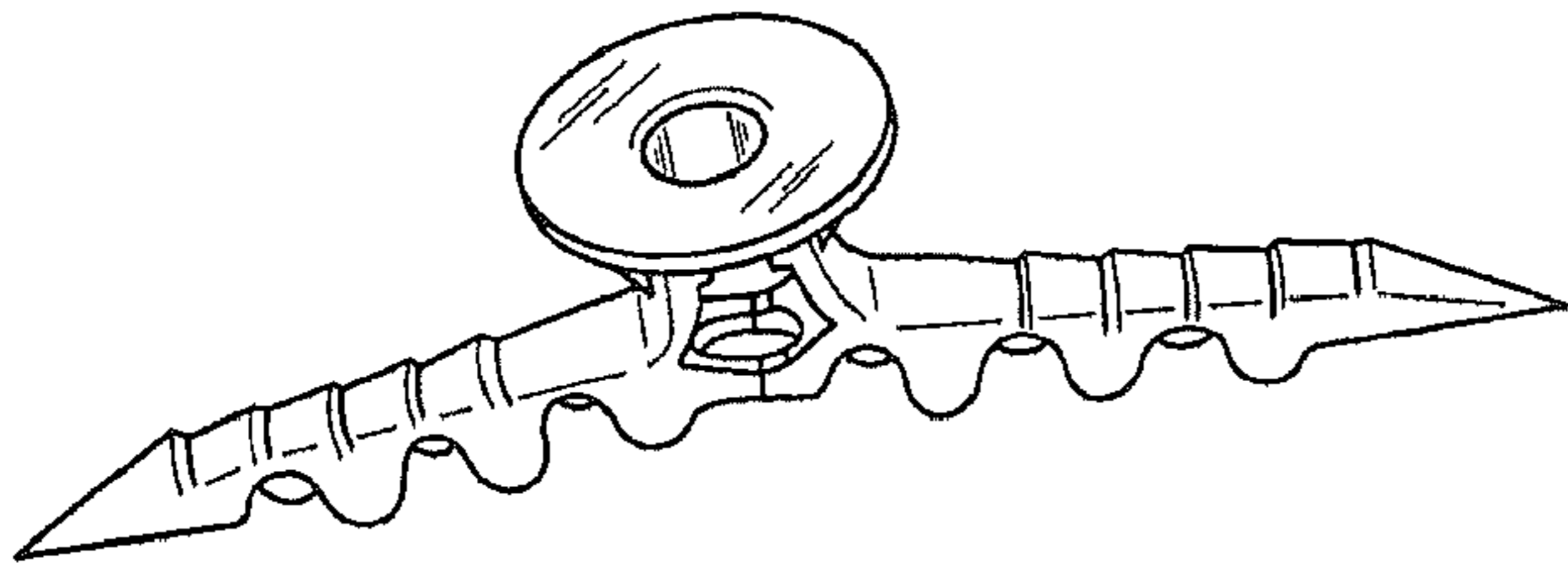

FIG. 6

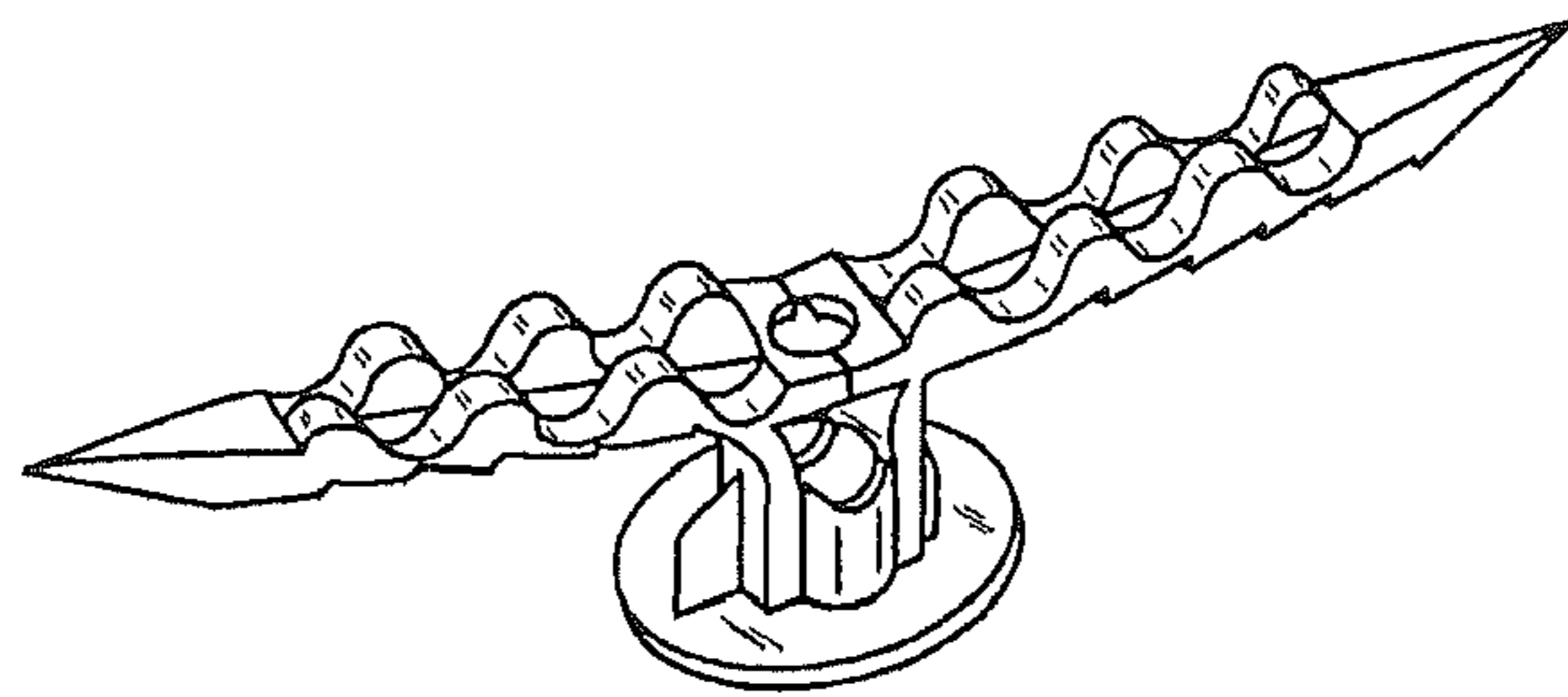

FIG. 7

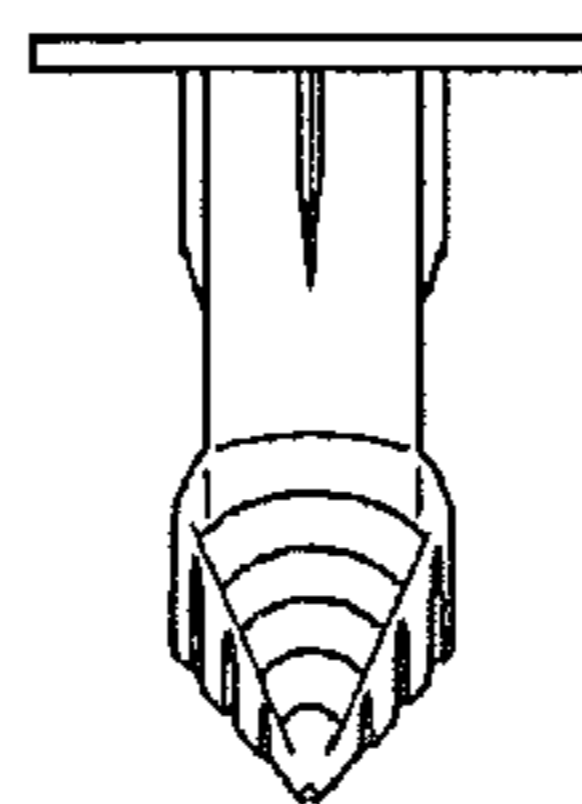

FIG. 8

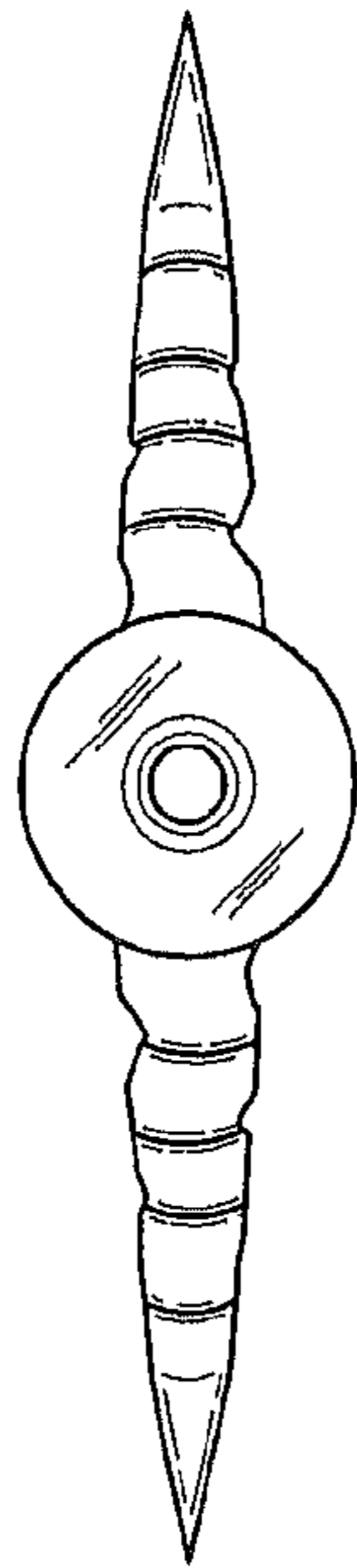

FIG. 9

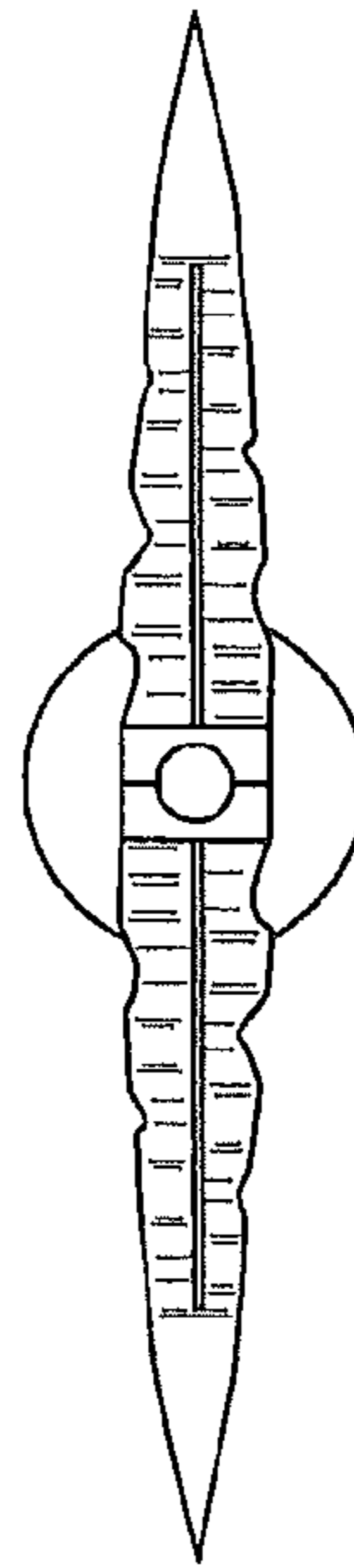

FIG. 10

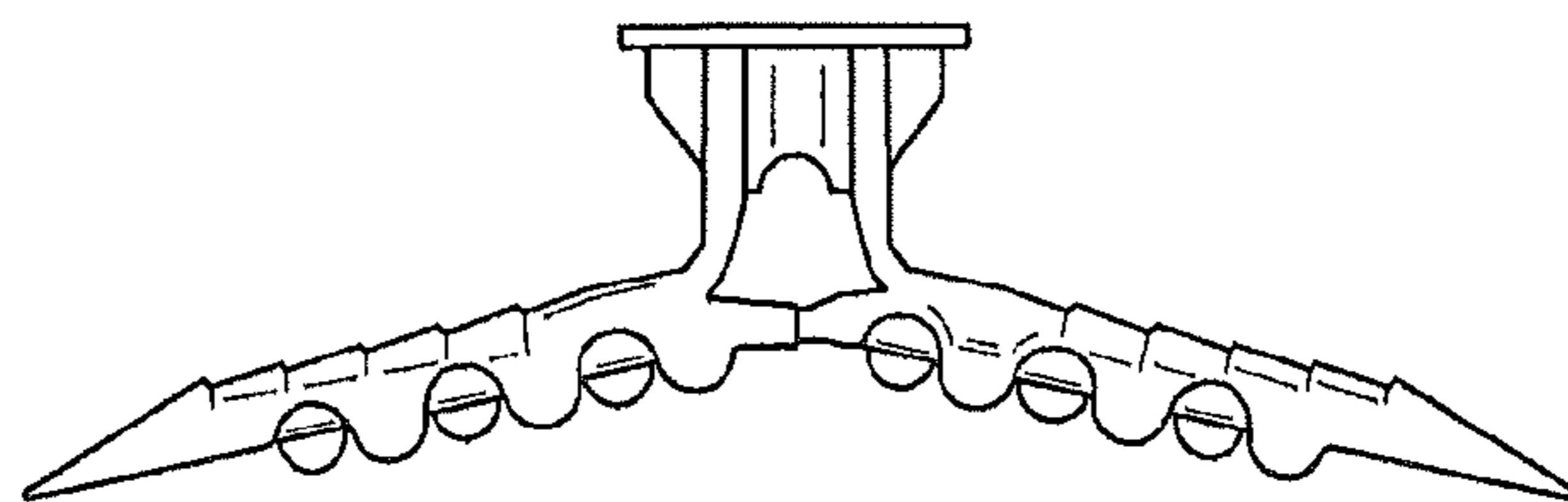

FIG. 11