

US00D660116S

(12) **United States Design Patent**  
**Owen et al.**

(10) **Patent No.:** **US D660,116 S**

(45) **Date of Patent:** **\*\* May 22, 2012**

(54) **PIPE CUTTER**

(75) Inventors: **Bryan Owen**, Wadsworth, OH (US);  
**David L. Machovina**, Elyria, OH (US)

(73) Assignee: **Emerson Electric Co.**, St. Louis, MO  
(US)

(\*\*) Term: **14 Years**

(21) Appl. No.: **29/387,091**

(22) Filed: **Mar. 9, 2011**

(51) **LOC (9) Cl.** ..... **08-03**

(52) **U.S. Cl.** ..... **D8/60**

(58) **Field of Classification Search** ..... D8/60,  
D8/61, 20; 83/887, 639.1, 455, 439, 82;  
82/92, 82, 73, 128, 113; 30/99, 98, 97, 96,  
30/95, 92, 102; 166/55.8, 55.6  
See application file for complete search history.

(56) **References Cited**

**U.S. PATENT DOCUMENTS**

2,869,413	A	1/1959	Anderson	
4,368,577	A *	1/1983	Babb	30/92
4,734,982	A	4/1988	Khoja	
D405,336	S	2/1999	Hepworth	
5,937,523	A	8/1999	Van Keppel et al.	
D453,287	S *	2/2002	Picaza	D8/60
D569,548	S	5/2008	Smith	
D578,851	S *	10/2008	Huang	D8/60
D612,698	S *	3/2010	Huang	D8/60

D614,929 S \* 5/2010 Kobayashi ..... D8/60  
D626,812 S 11/2010 Macsay et al.

\* cited by examiner

*Primary Examiner* — Austin Murphy

(74) *Attorney, Agent, or Firm* — Rankin, Hill & Clark LLP

(57) **CLAIM**

The ornamental design for a pipe cutter, as shown and described.

**DESCRIPTION**

FIG. 1 is a front left perspective view of a preferred embodiment pipe cutter.

FIG. 2 is a left side view of the pipe cutter of FIG. 1.

FIG. 3 is a right side view of the pipe cutter of FIG. 1.

FIG. 4 is a rear elevational view of the pipe cutter of FIG. 1.

FIG. 5 is a front elevational view of the pipe cutter of FIG. 1.

FIG. 6 is a top plan view of the pipe cutter of FIG. 1.

FIG. 7 is a bottom plan view of the pipe cutter of FIG. 1.

FIG. 8 is a front left perspective view of another preferred embodiment pipe cutter.

FIG. 9 is a left side view of the pipe cutter of FIG. 8.

FIG. 10 is a right side view of the pipe cutter of FIG. 8.

FIG. 11 is a rear elevational view of the pipe cutter of FIG. 8.

FIG. 12 is a front elevational view of the pipe cutter of FIG. 8.

FIG. 13 is a top plan view of the pipe cutter of FIG. 8; and,

FIG. 14 is a bottom plan view of the pipe cutter of FIG. 8.

The dash lines in FIGS. 1-5, 7-12, and 14 are for illustrative purposes only showing environmental subject matter and form no part of the claimed design.

**1 Claim, 14 Drawing Sheets**

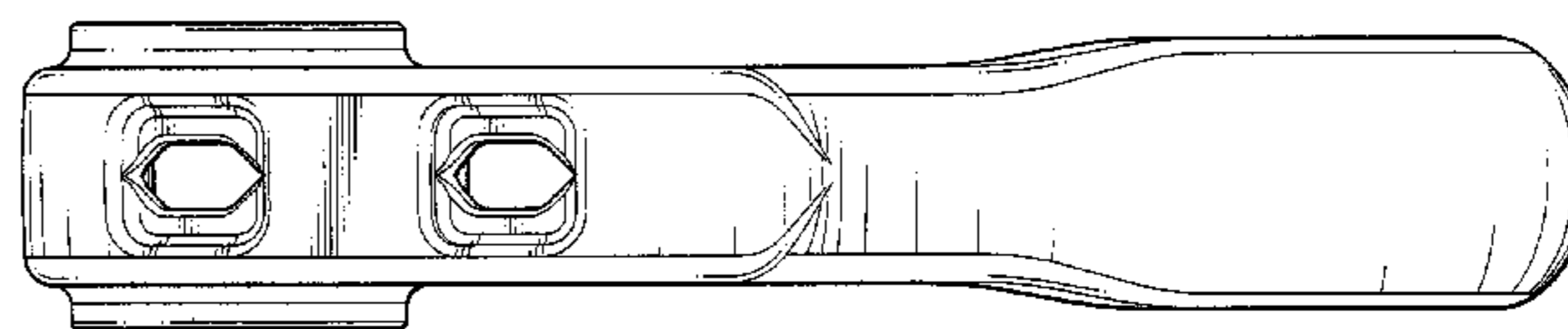
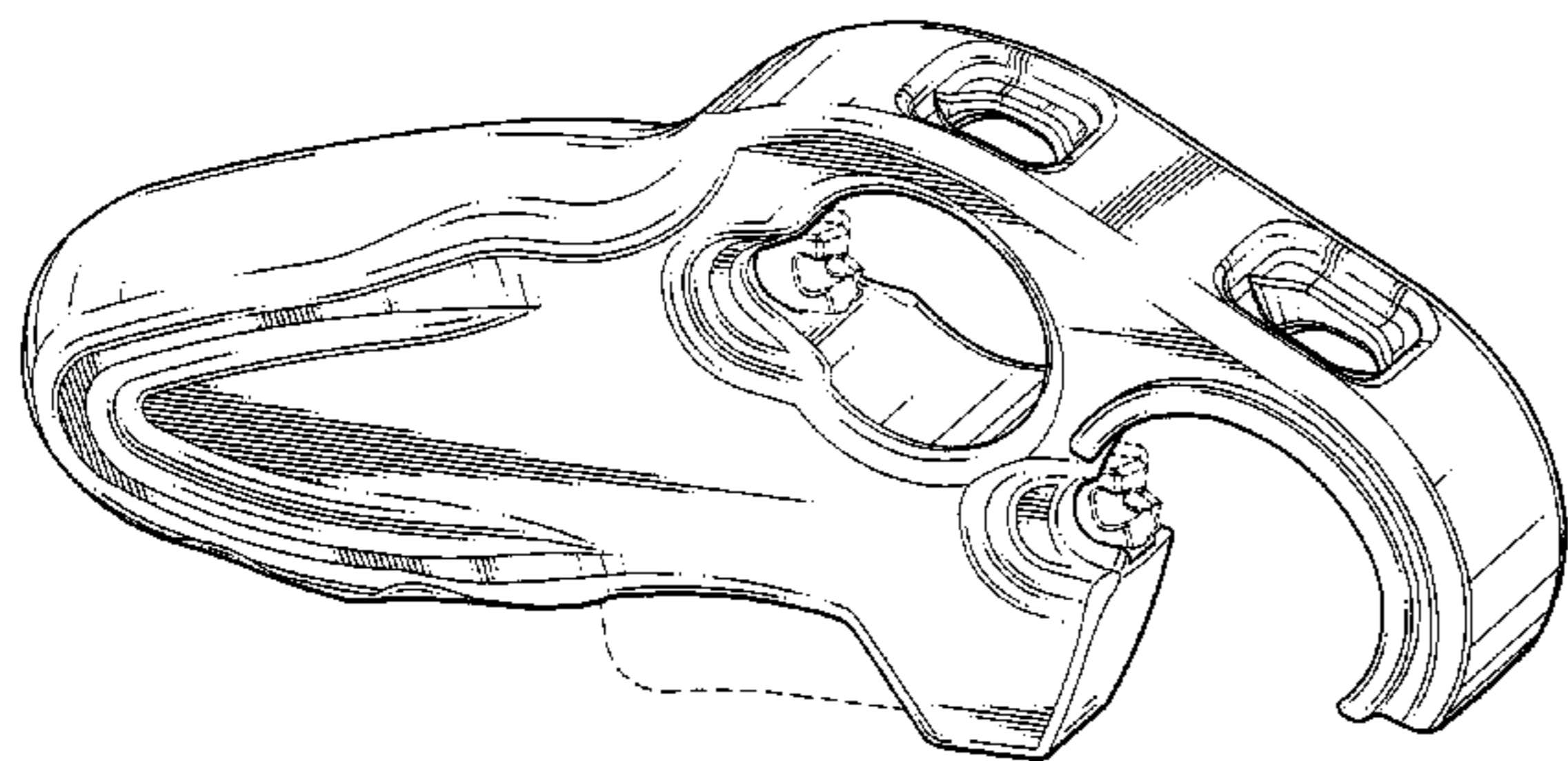

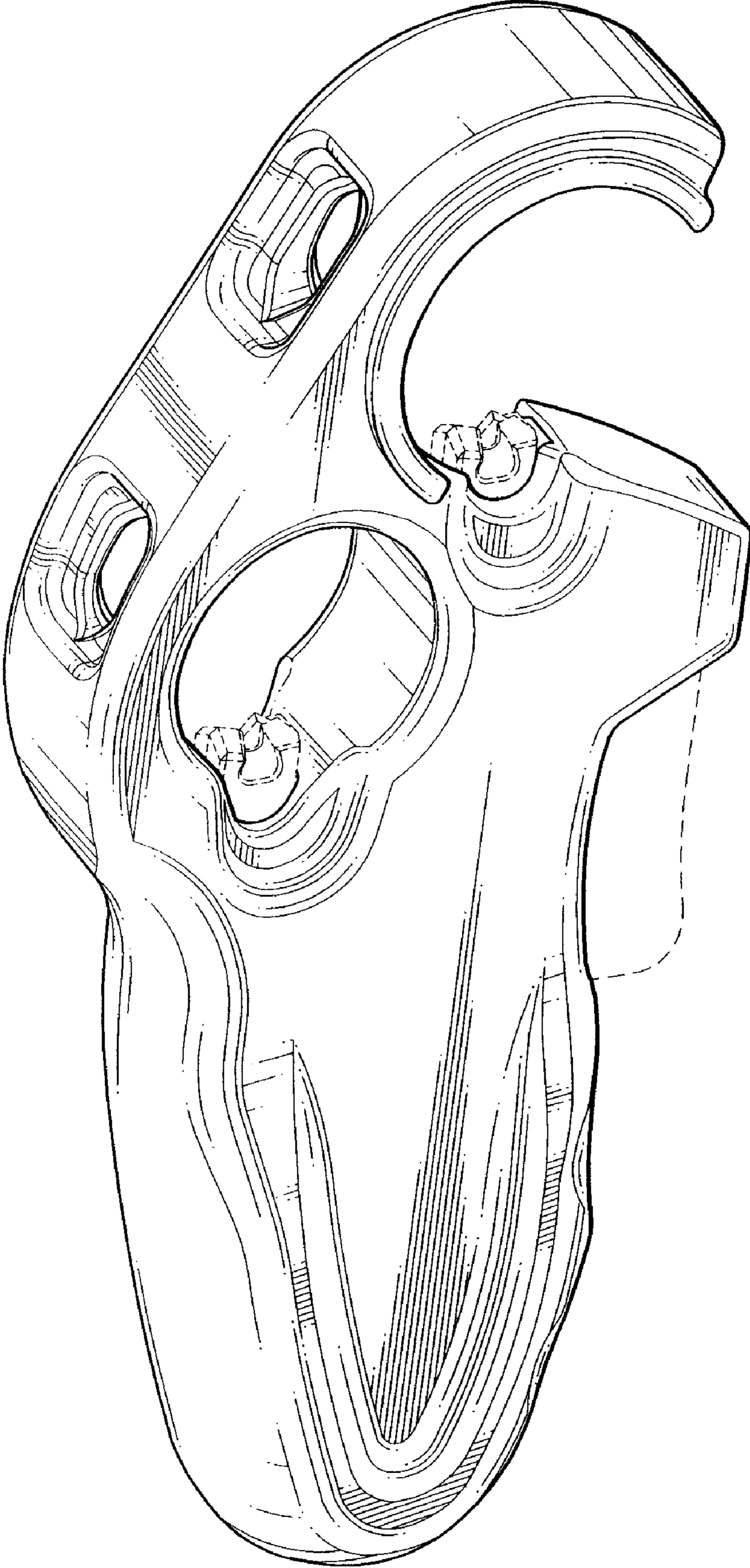

FIG. 1

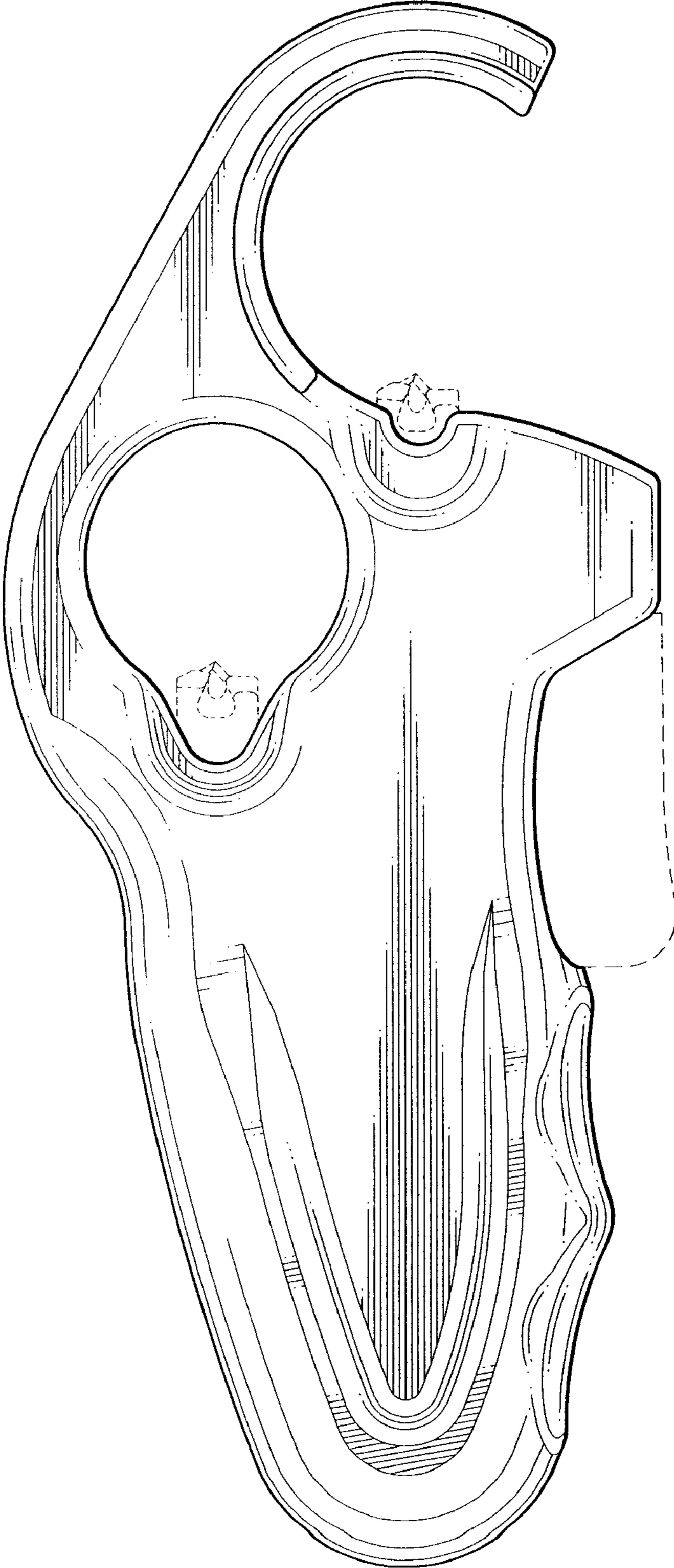

FIG. 2

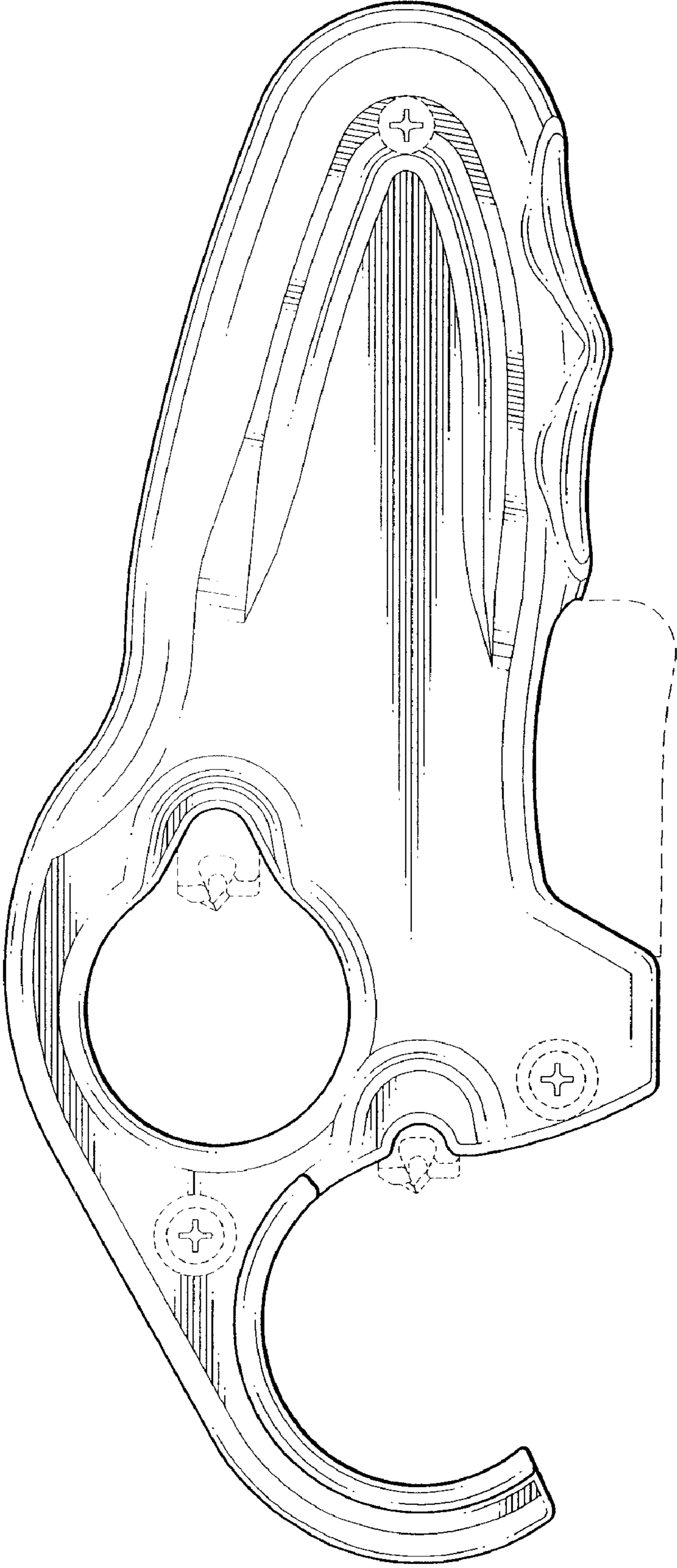

FIG. 3

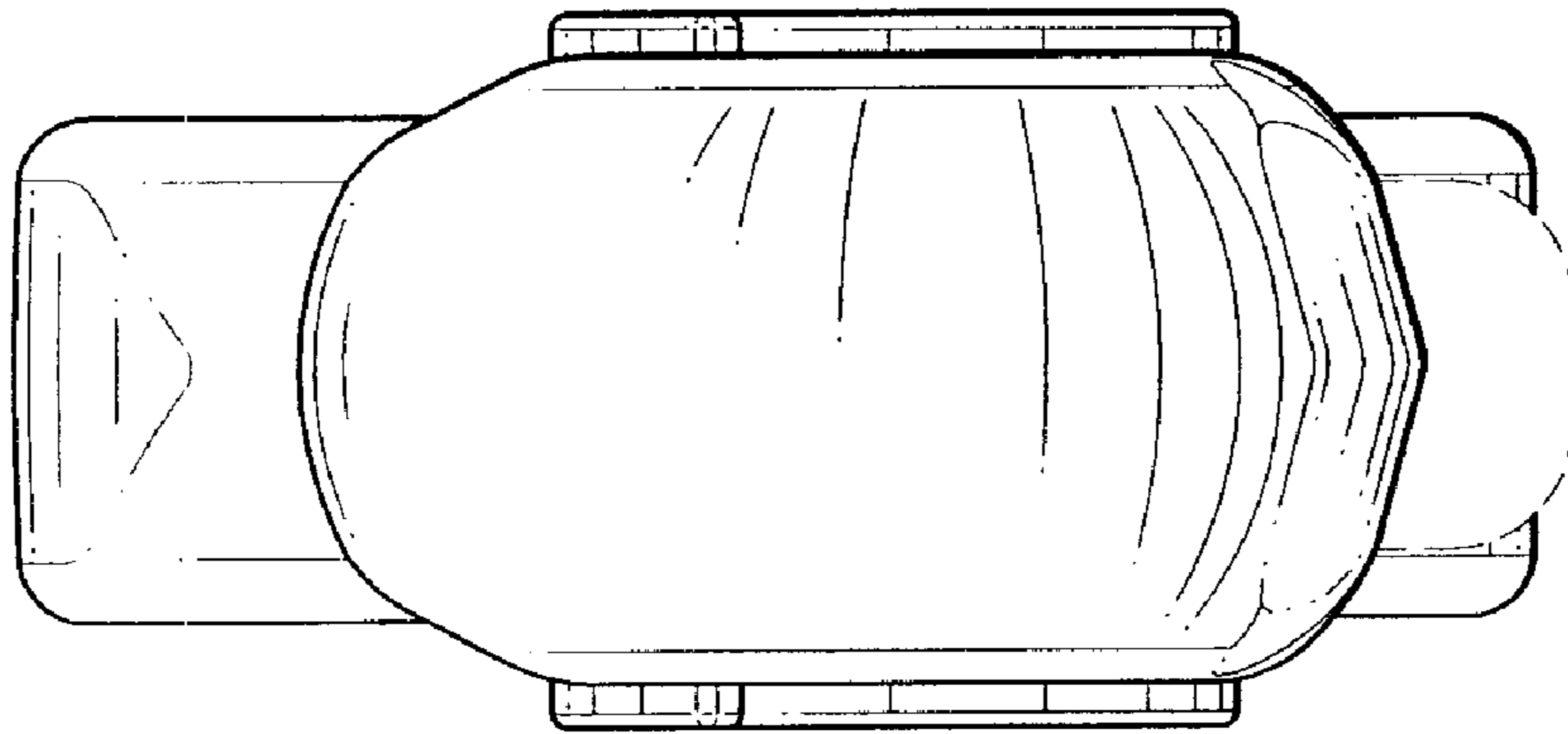

FIG. 4

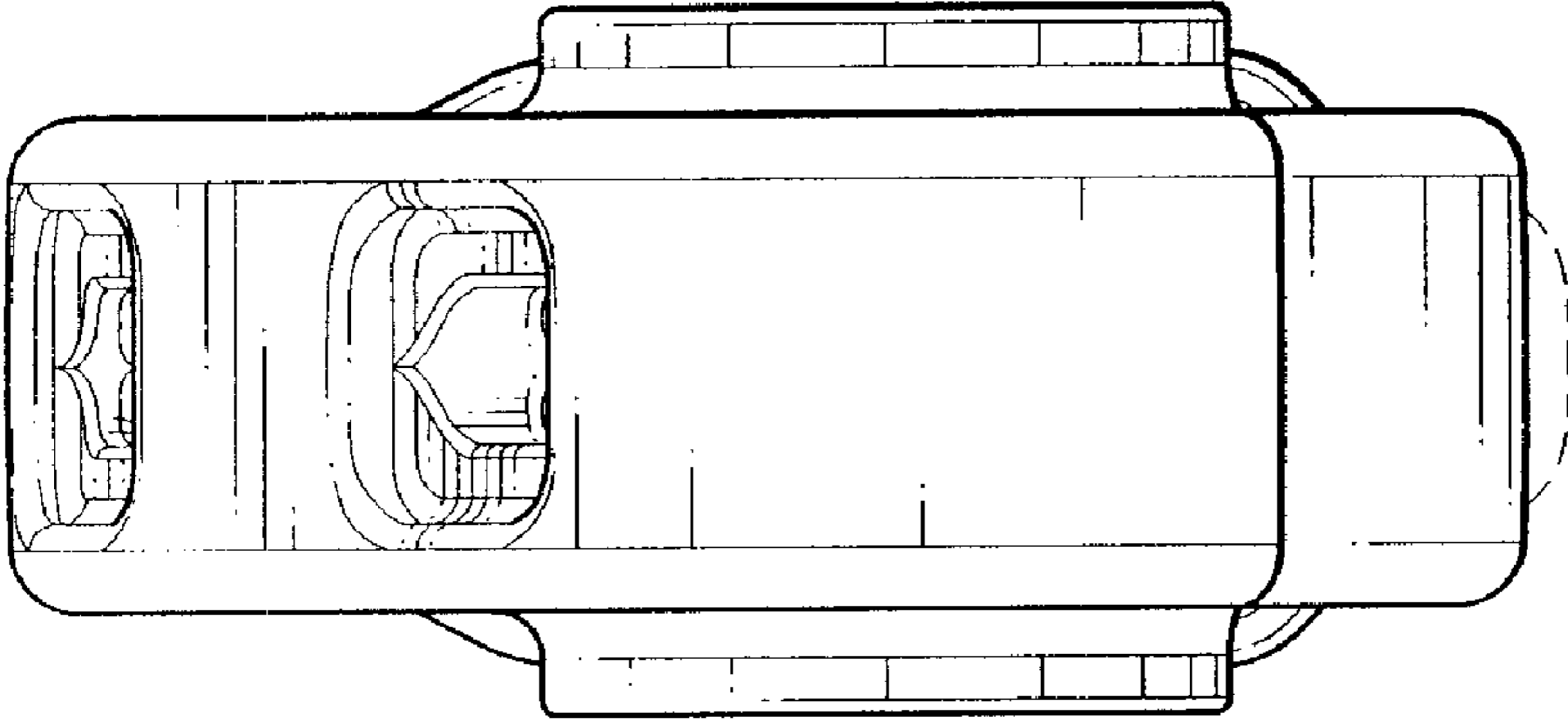

FIG. 5

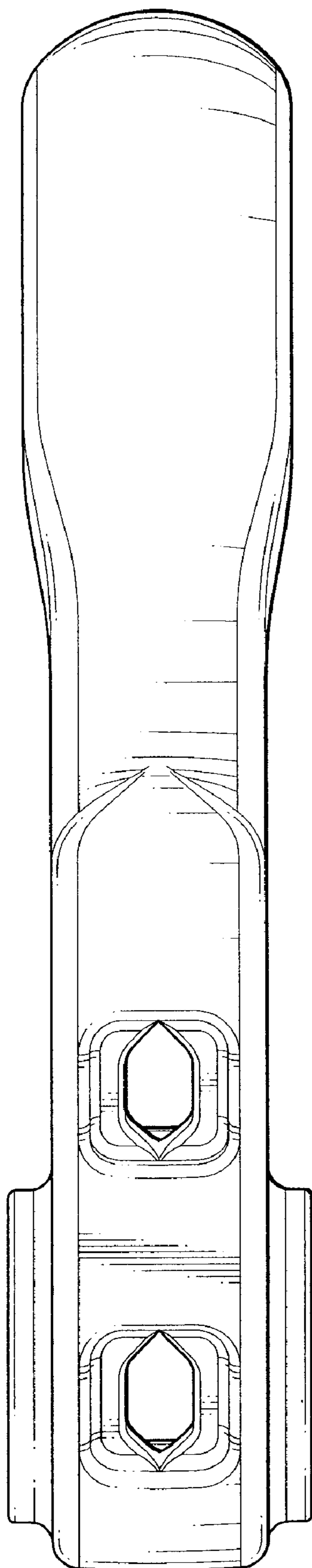

FIG. 6

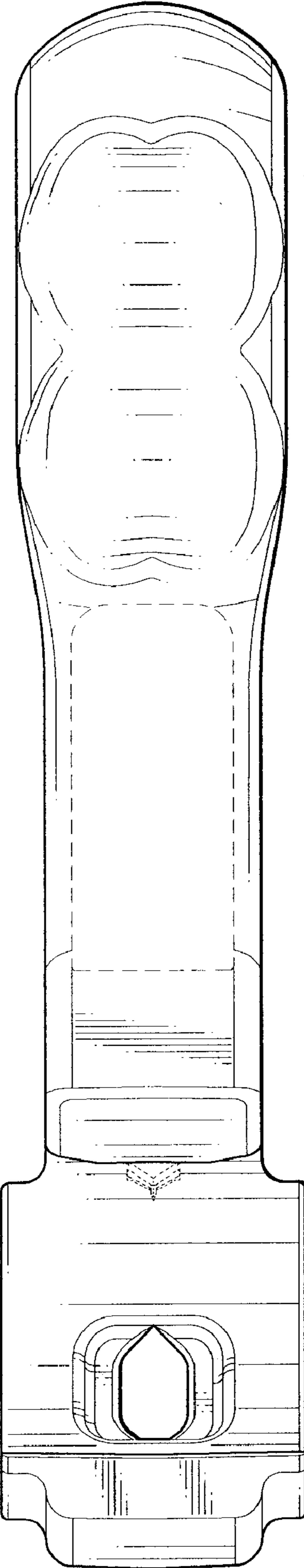

FIG. 7



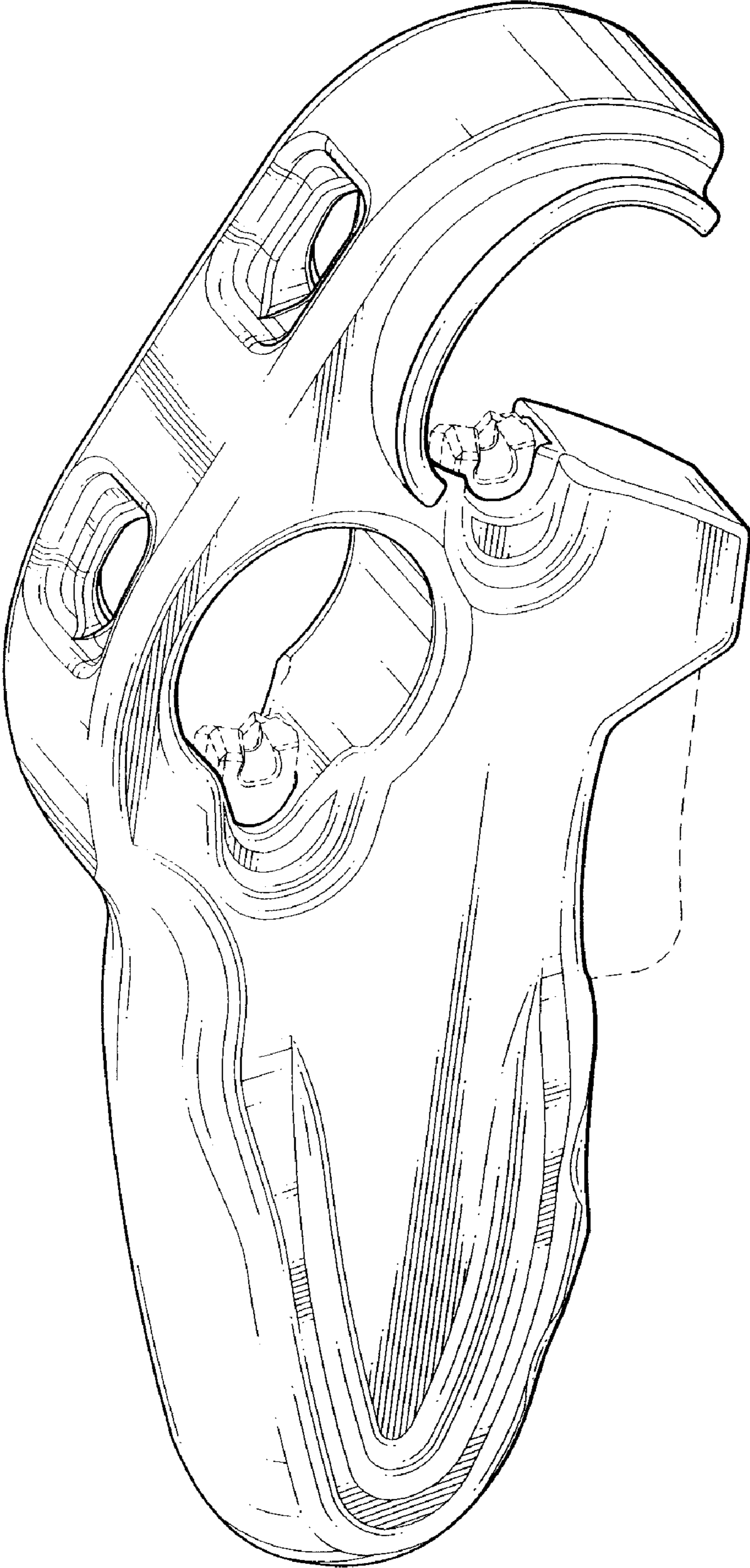

FIG. 8

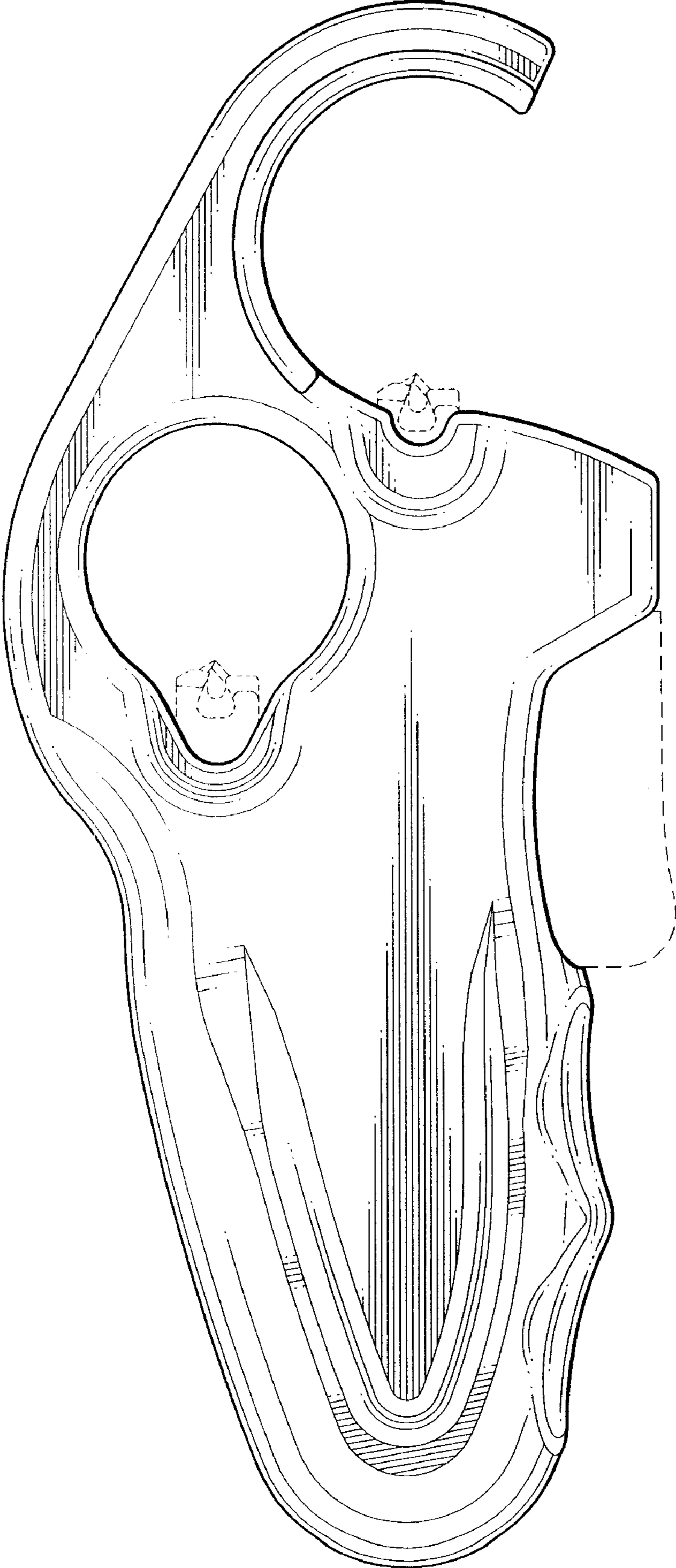

FIG. 9

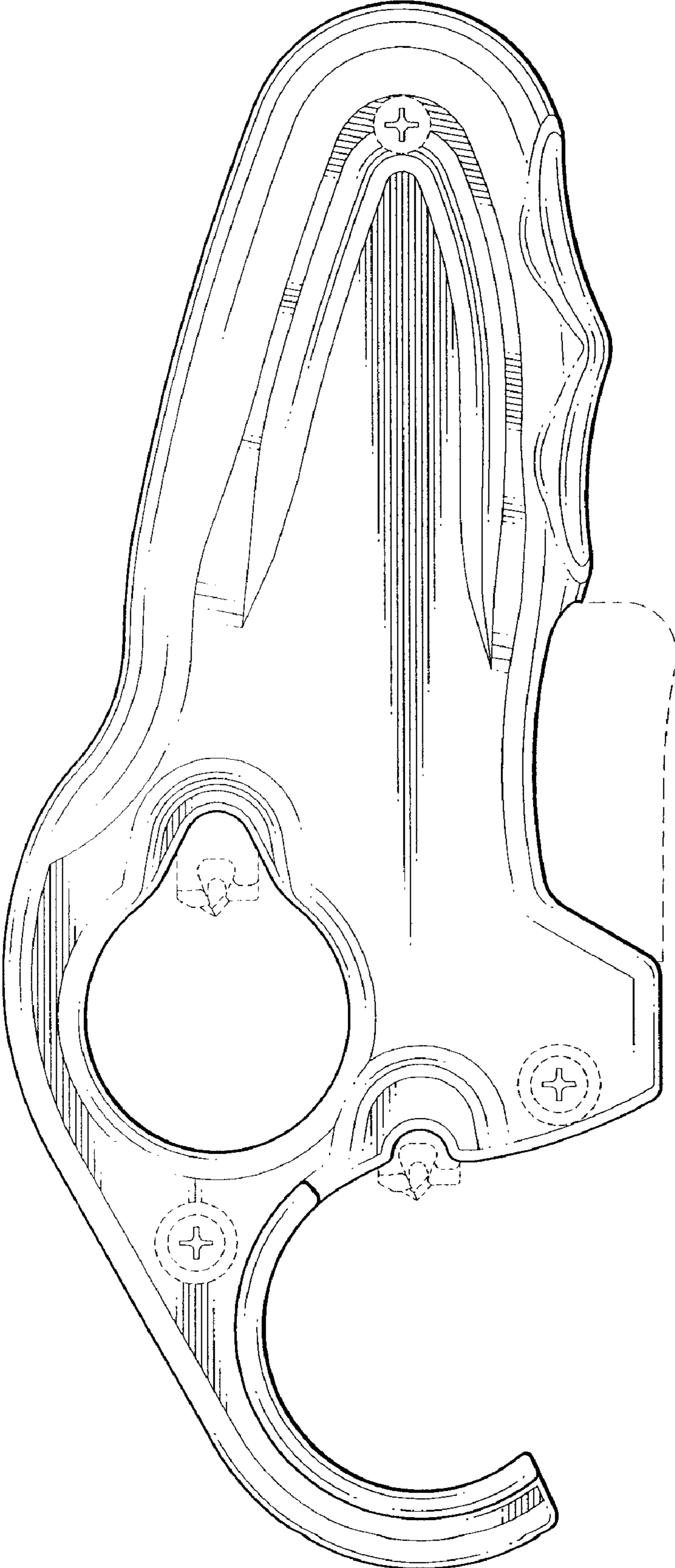

FIG. 10

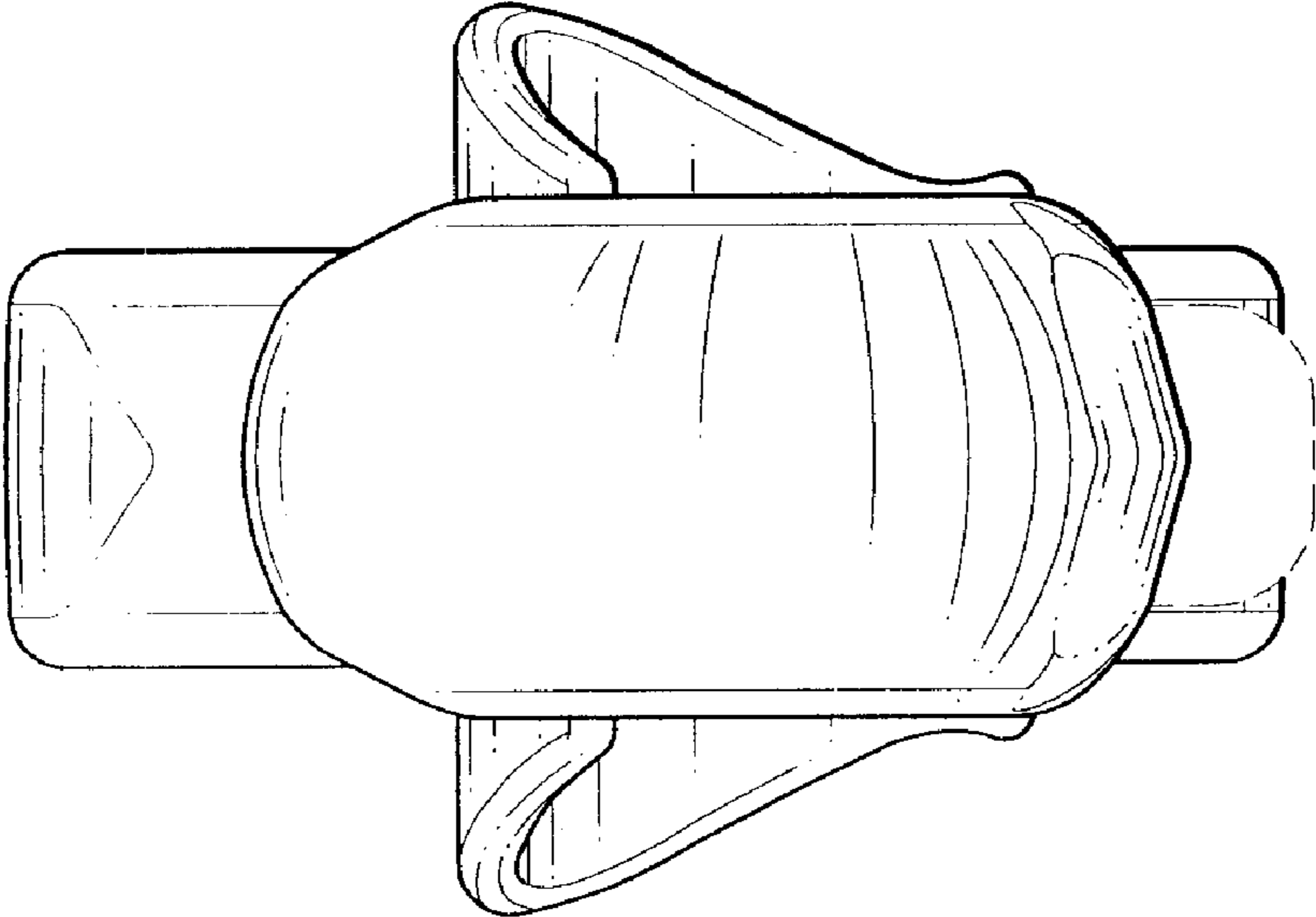

FIG. 11

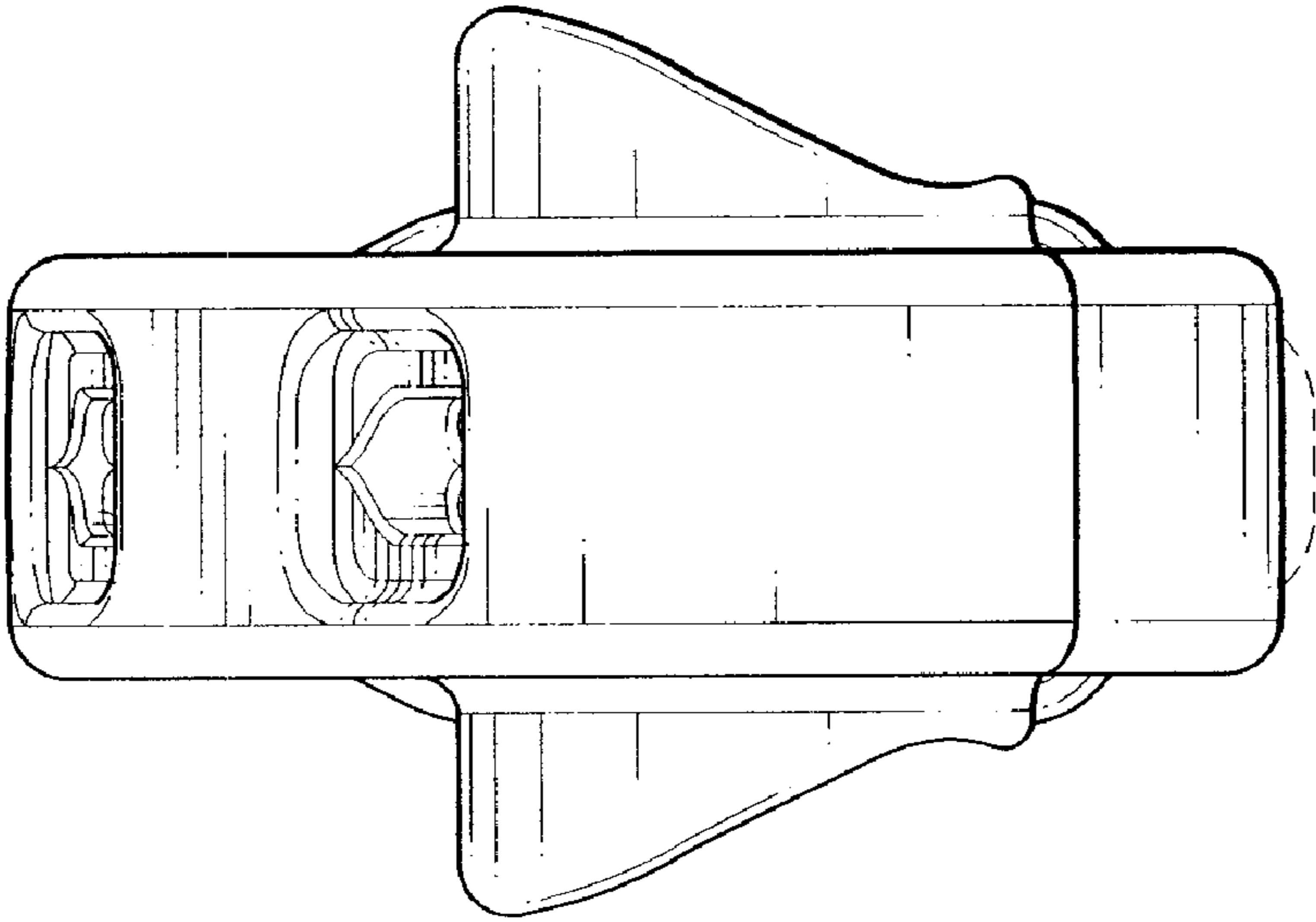

FIG. 12

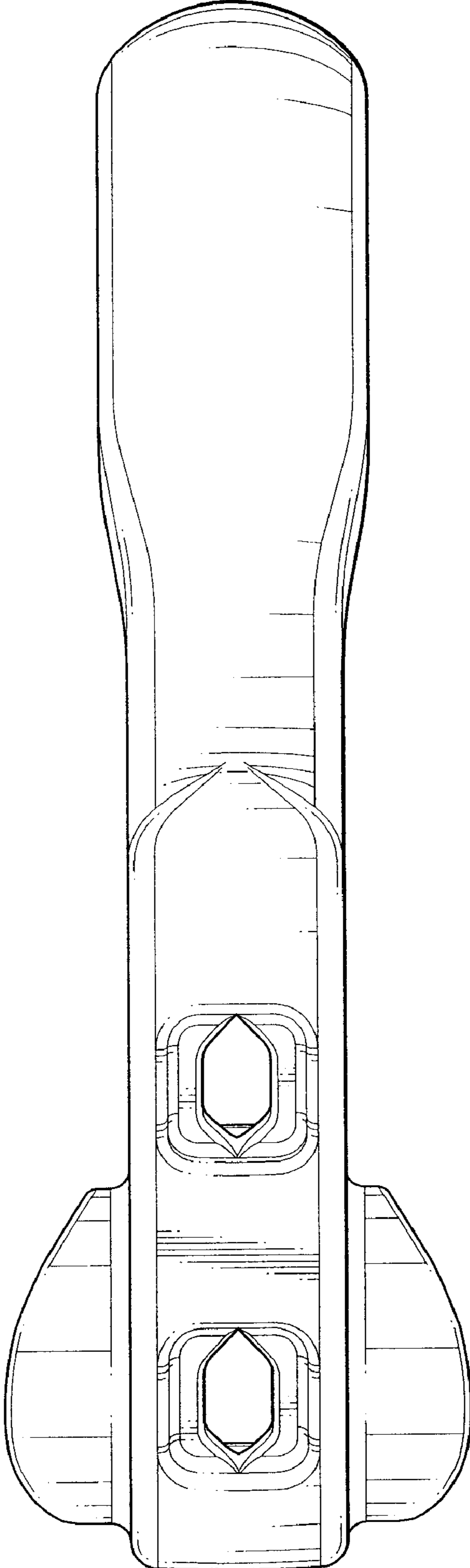

FIG. 13

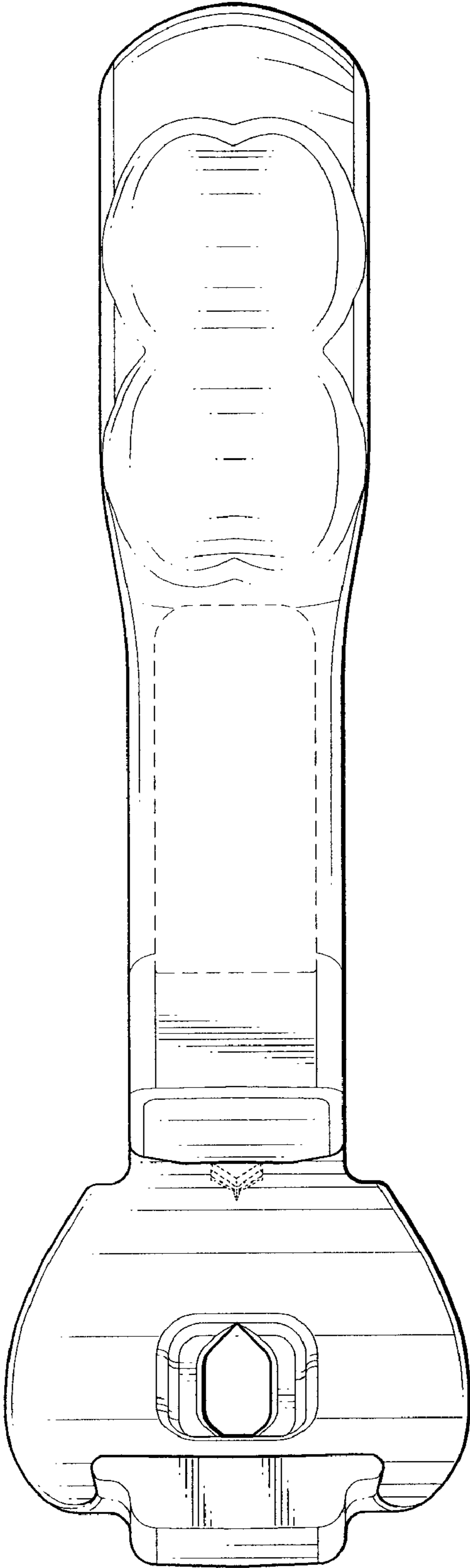

FIG. 14