

US00D660080S

(12) **United States Design Patent**
Littlejohn

(10) **Patent No.:** **US D660,080 S**

(45) **Date of Patent:** **** May 22, 2012**

(54) **SPOUT FOR DISPENSING BEVERAGES**

(75) Inventor: **Marc Littlejohn**, Edison, NJ (US)

(73) Assignee: **Home Essentials & Beyond, Inc.**,
Edison, NJ (US)

(**) Term: **14 Years**

(21) Appl. No.: **29/385,143**

(22) Filed: **Feb. 9, 2011**

(51) **LOC (9) Cl.** **07-99**

(52) **U.S. Cl.** **D7/398; D7/397**

(58) **Field of Classification Search** D7/300,
D7/397, 398; 137/801; D23/255, 257, 264;
222/505, 508

See application file for complete search history.

(56) **References Cited**

U.S. PATENT DOCUMENTS

D189,335 S * 11/1960 Whetstone D7/398
3,104,089 A * 9/1963 Seltsam 251/263
D241,841 S * 10/1976 Frahm et al. D7/398

5,449,144 A * 9/1995 Kowalics 251/99
D637,867 S * 5/2011 Wang D7/398
D652,685 S * 1/2012 Carter D7/622

* cited by examiner

Primary Examiner — Marianne Pandozzi

(74) *Attorney, Agent, or Firm* — Cozen O'Connor

(57) **CLAIM**

The ornamental design for a spout for dispensing beverages, as shown and described.

DESCRIPTION

FIG. 1 is a left side perspective view of a spout for dispensing beverages showing my new design;
FIG. 2 is a right side elevational view thereof;
FIG. 3 is a top view thereof;
FIG. 4 is a front view thereof;
FIG. 5 is a rear view thereof; and,
FIG. 6 is a bottom view thereof.
The broken lines in the Figures designate features which form no part of the claimed design.

1 Claim, 3 Drawing Sheets

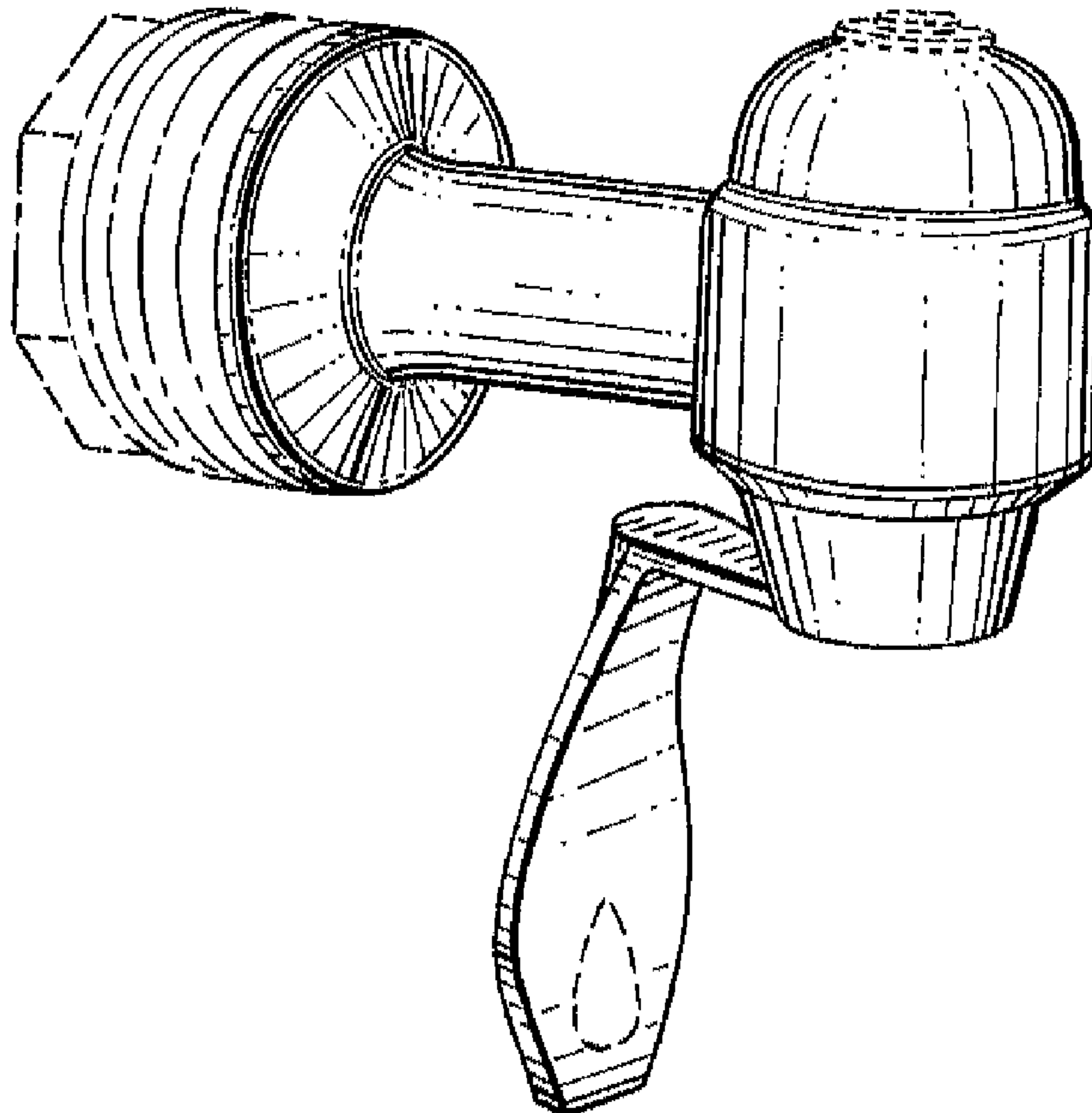

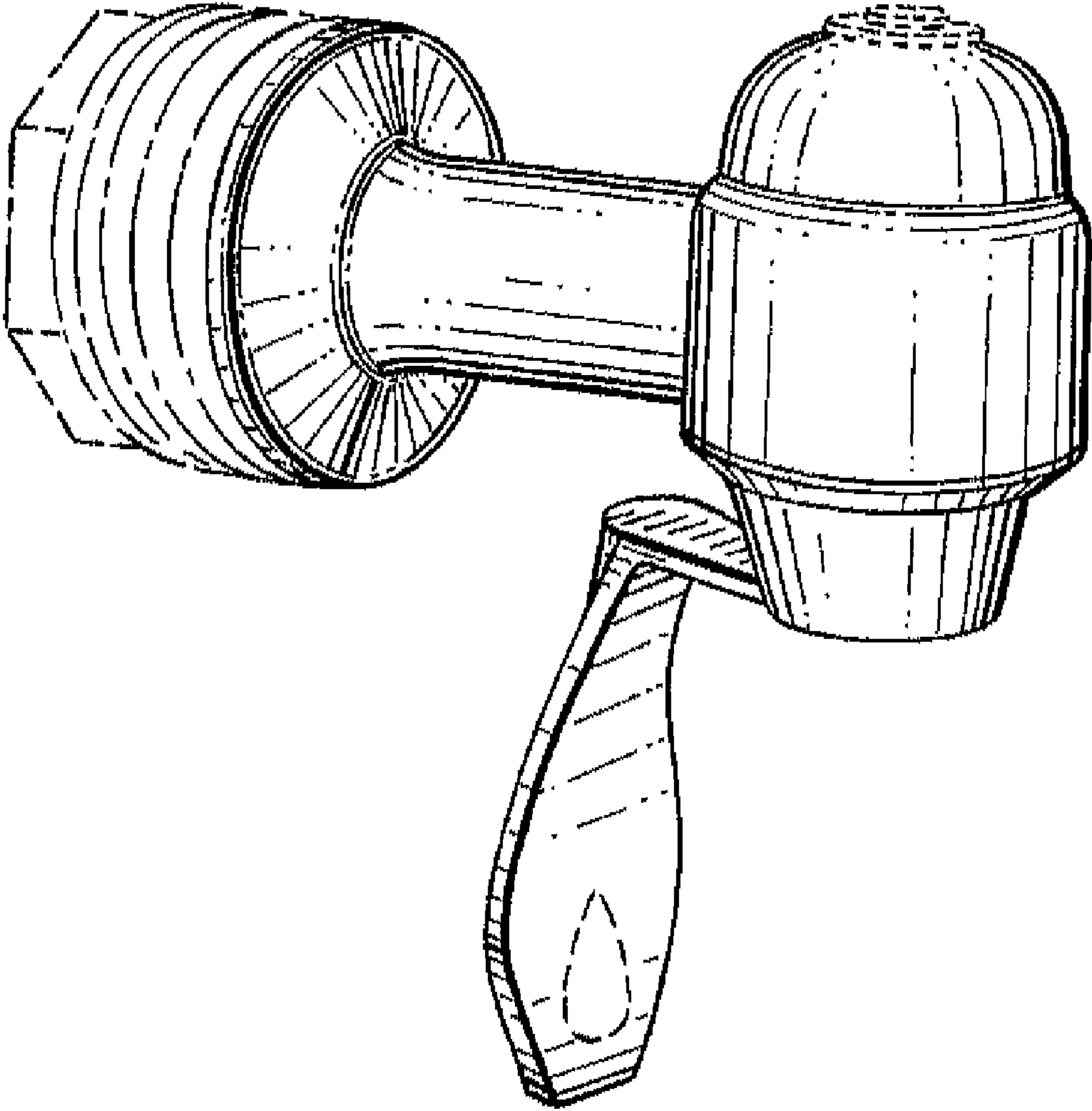

FIG. 1

FIG.2

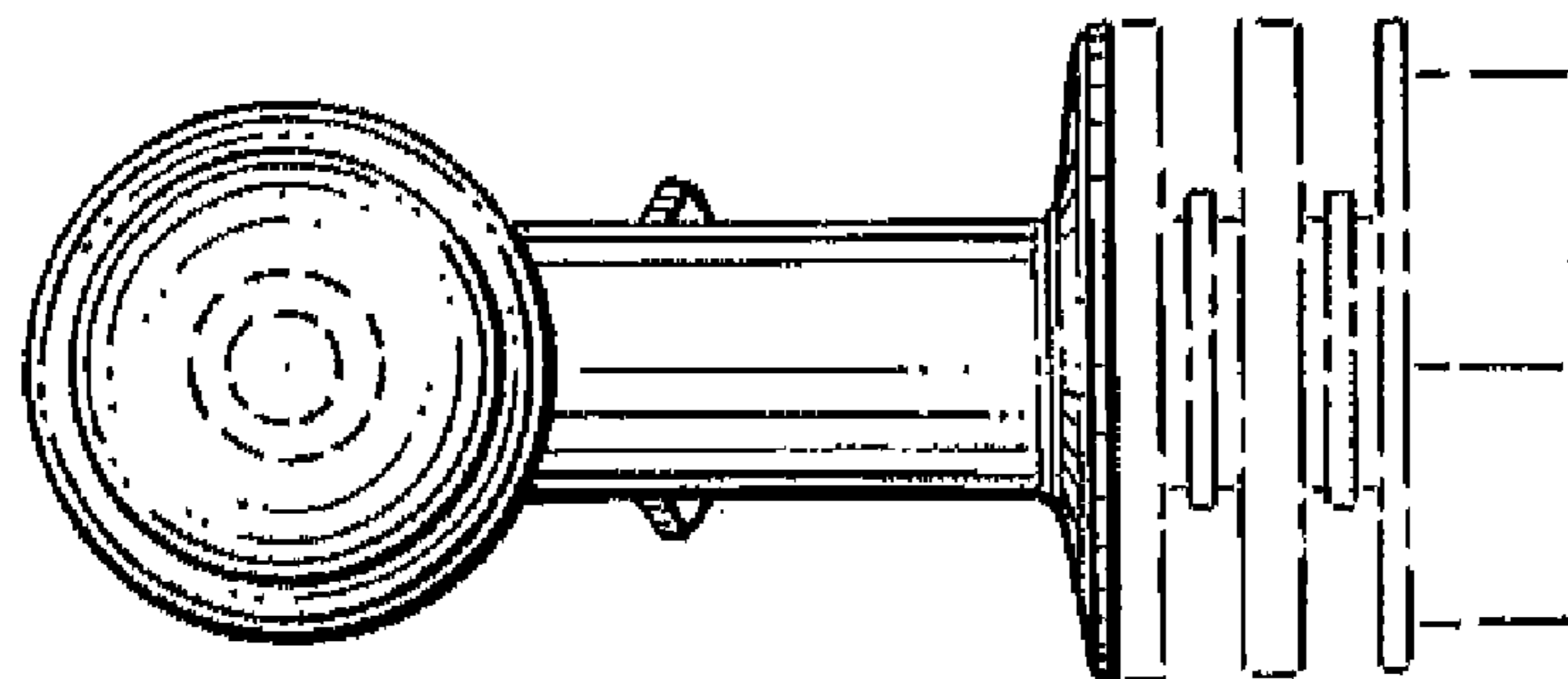
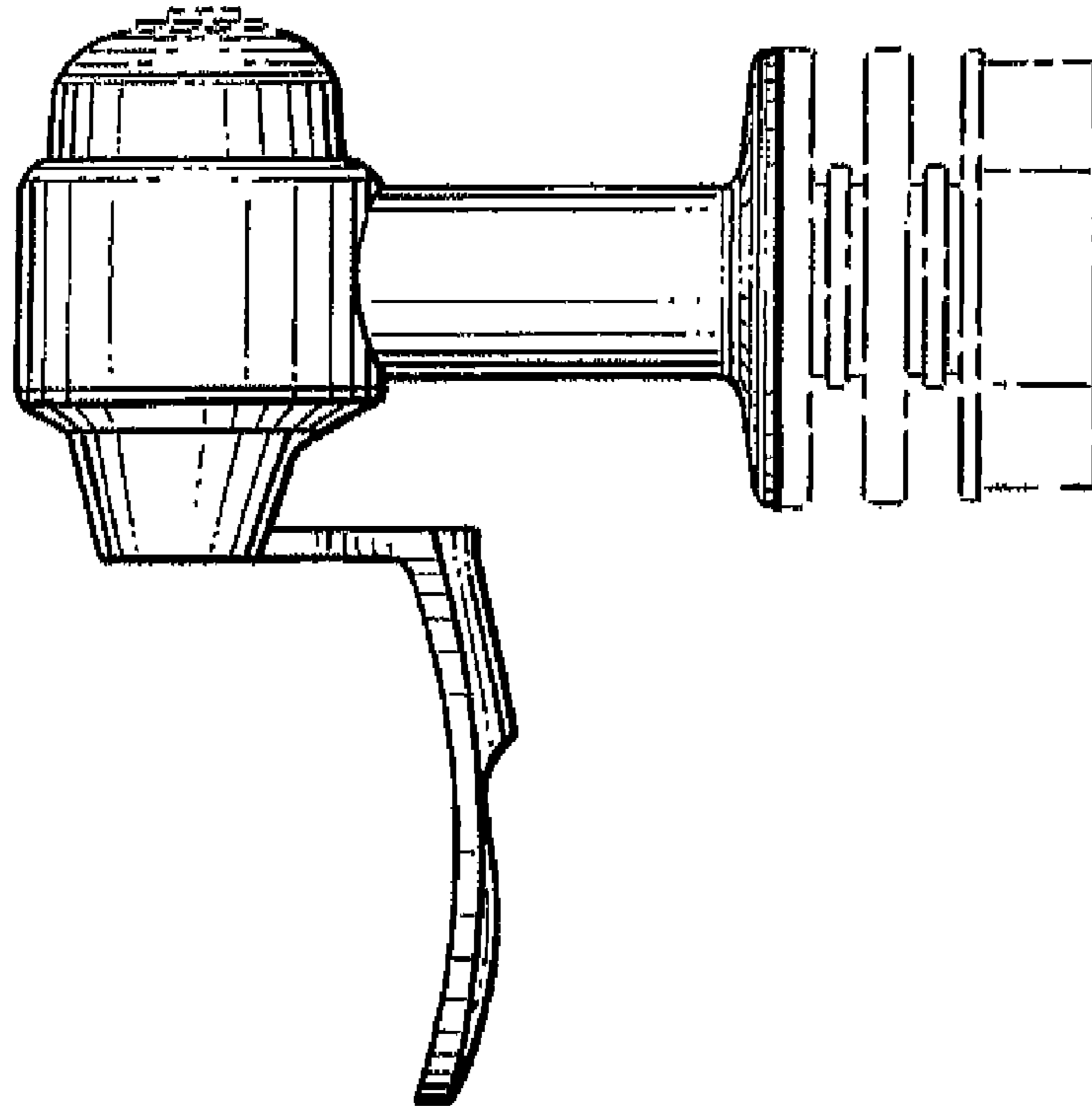

FIG.3

FIG.4

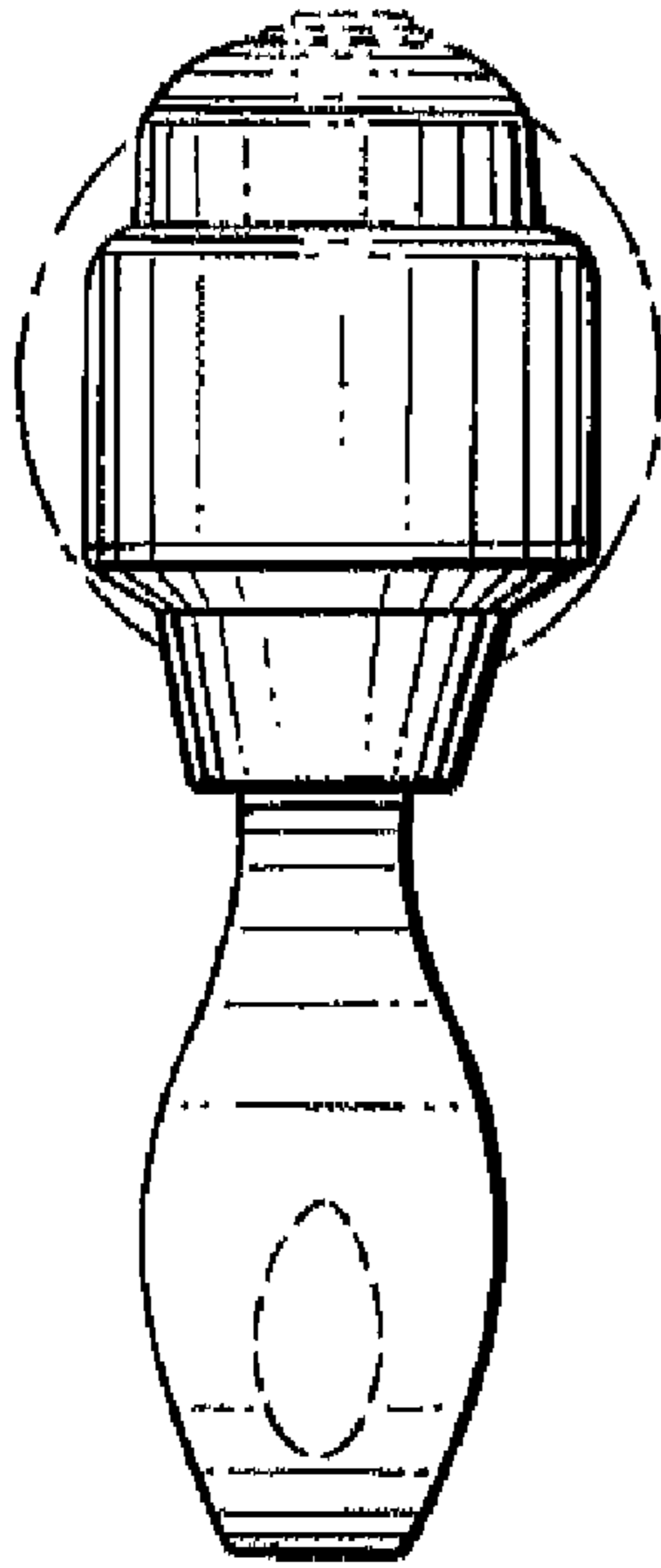

FIG.5

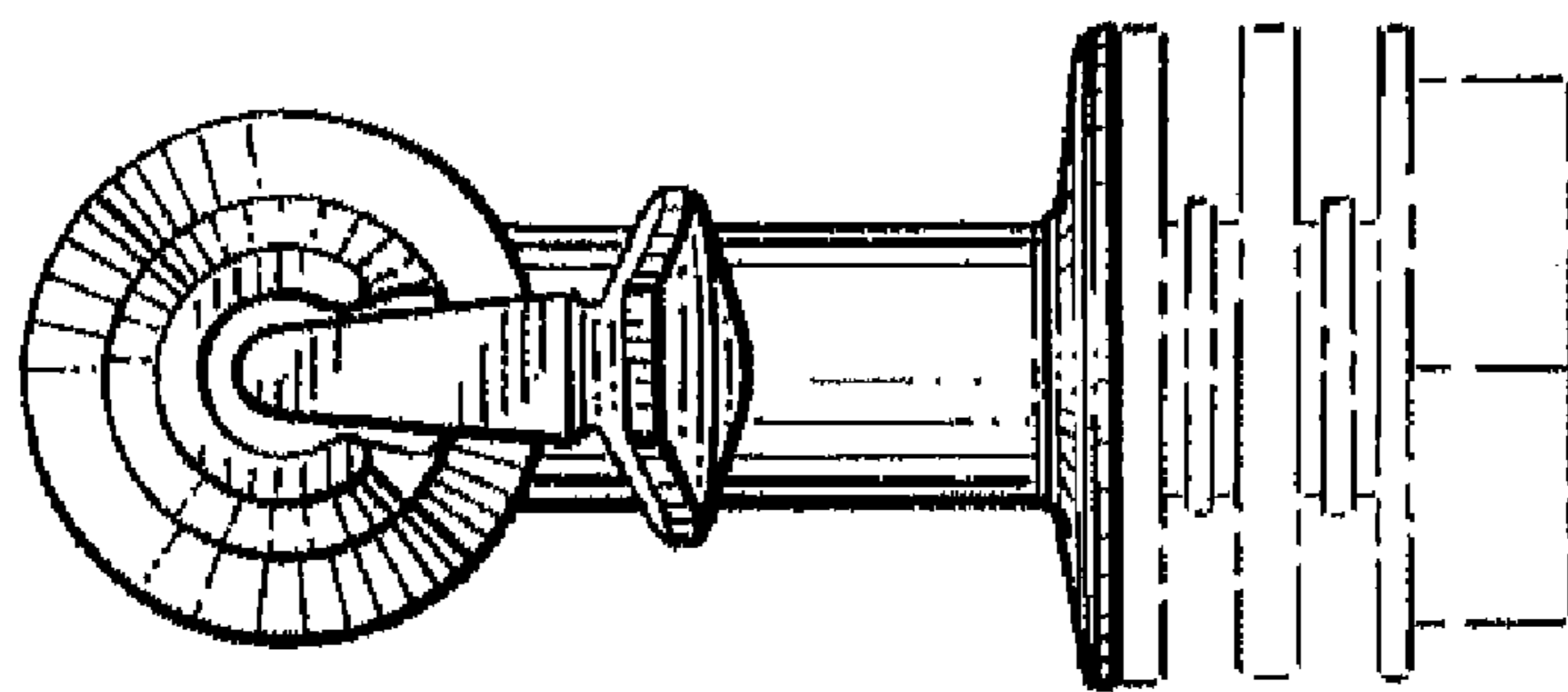
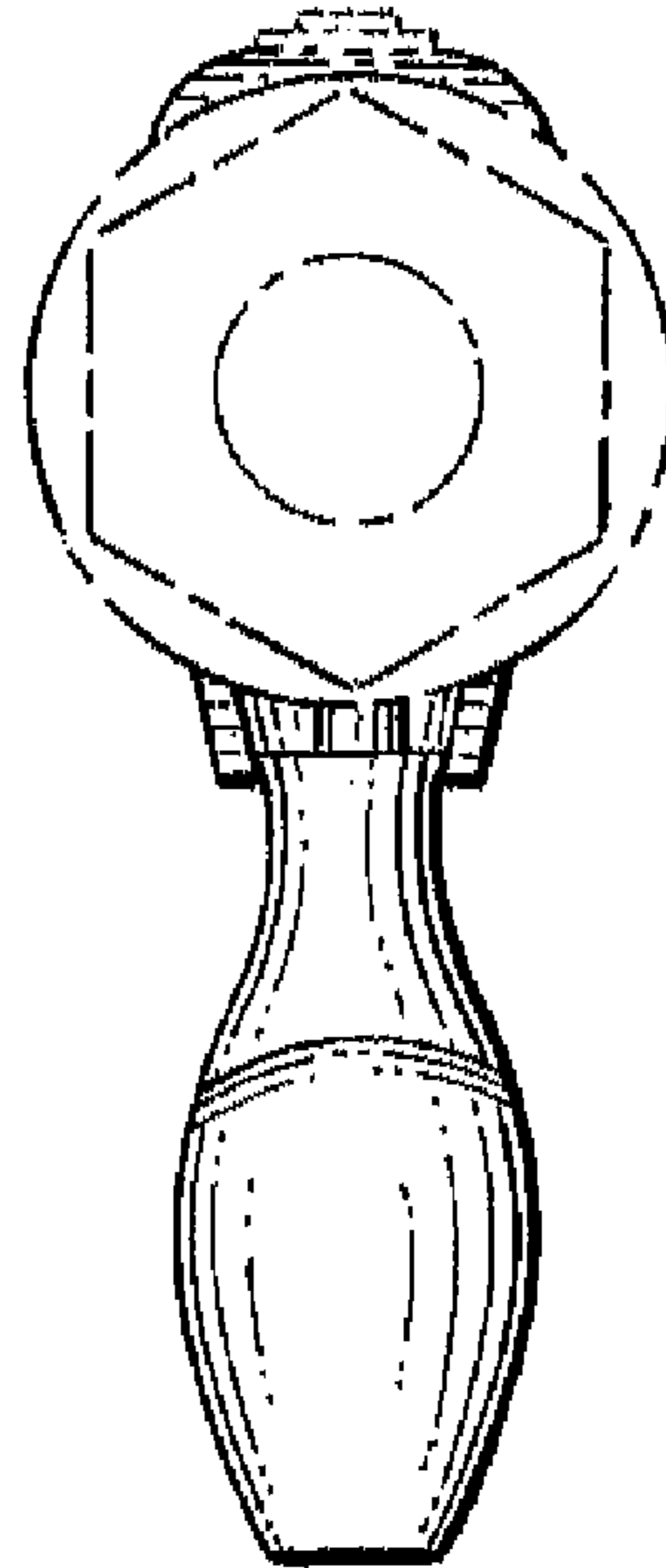

FIG.6