

US00D660043S

(12) **United States Design Patent**
Nguyen

(10) **Patent No.:** **US D660,043 S**

(45) **Date of Patent:** **** May 22, 2012**

(54) **DAYBED**

(75) Inventor: **Huu Toan Nguyen**, Milan (IT)

(73) Assignee: **Dedon GmbH**, Luneburg (DE)

(**) Term: **14 Years**

(21) Appl. No.: **29/378,473**

(22) Filed: **Nov. 4, 2010**

(30) **Foreign Application Priority Data**

Aug. 5, 2010 (EM) 001740309

(51) **LOC (9) Cl.** **06-01**

(52) **U.S. Cl.** **D6/377; D6/369**

(58) **Field of Classification Search** D6/334-336,
D6/360, 361, 369, 377, 378, 381, 500-502;
297/232, 423.1, 451.9, 452.64

See application file for complete search history.

(56) **References Cited**

U.S. PATENT DOCUMENTS

D181,989 S * 1/1958 Lubberts D6/377

D339,246 S * 9/1993 Hutton D6/377

D344,860 S * 3/1994 McGuire D6/369

D390,029 S * 2/1998 Hutton D6/377

D393,754 S * 4/1998 Marks D6/361

D416,704 S * 11/1999 Mourgue D6/377

D431,381 S * 10/2000 Gomez D6/361

D448,196 S * 9/2001 Gomez D6/377

D648,565 S * 11/2011 Frinier D6/377

* cited by examiner

Primary Examiner — Mimosa De

(74) *Attorney, Agent, or Firm* — C. Brandon Browning;
Maynard Cooper & Gale, PC

(57) **CLAIM**

The ornamental design for a daybed, as shown and described.

DESCRIPTION

FIG. 1 is a front perspective view of a chair in accordance with the present invention.

FIG. 2 is a side elevational view of the daybed of FIG. 1.

FIG. 3 is a side elevational view of the daybed of FIG. 1.

FIG. 4 is a front elevational view of the daybed of FIG. 1.

FIG. 5 is rear elevational view of the daybed of FIG. 1; and,

FIG. 6 is a top plan view of the daybed of FIG. 1.

The fragmented depictions of weave pattern shown in the views are understood to repeat throughout the areas shown.

1 Claim, 5 Drawing Sheets

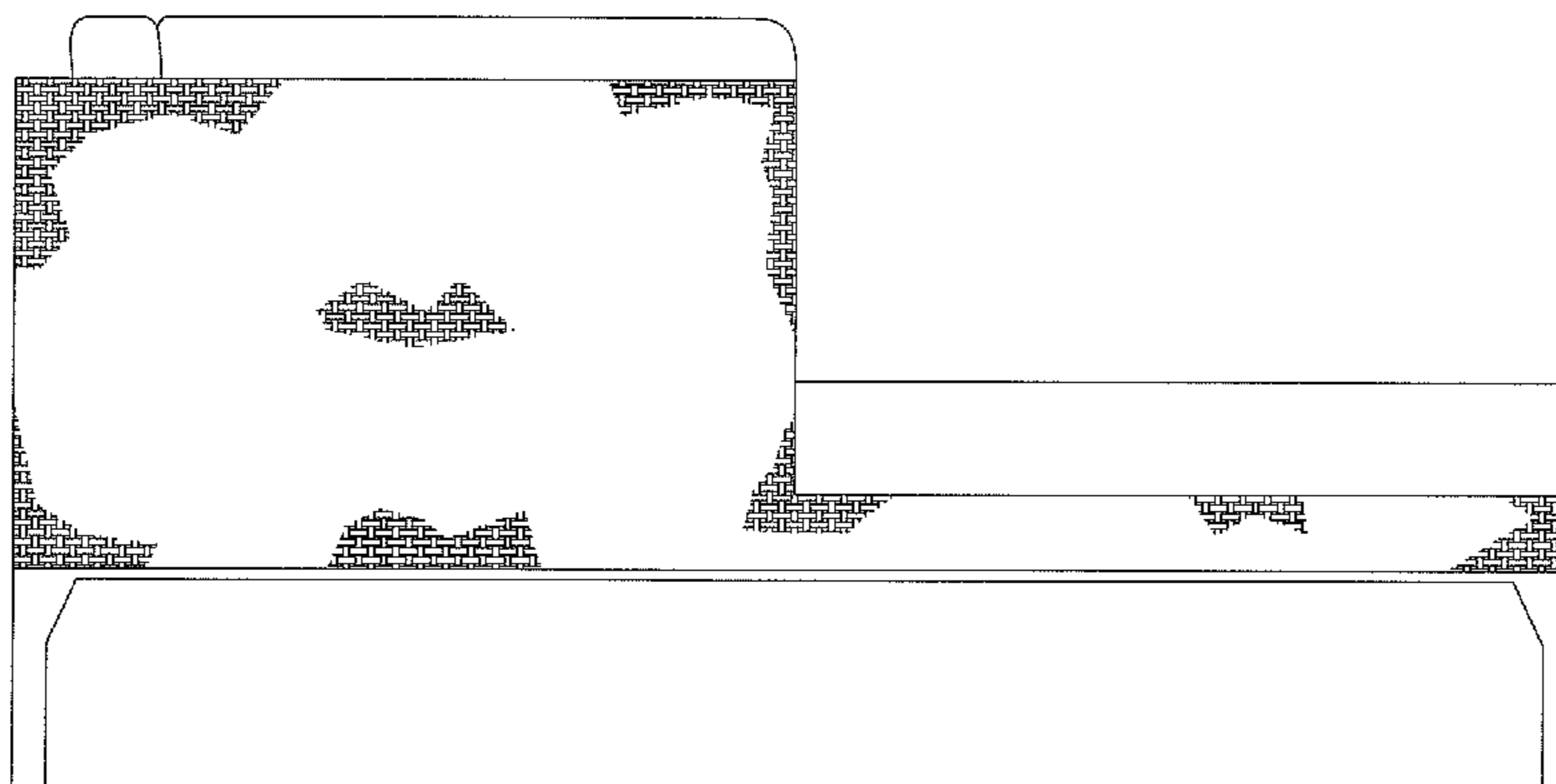
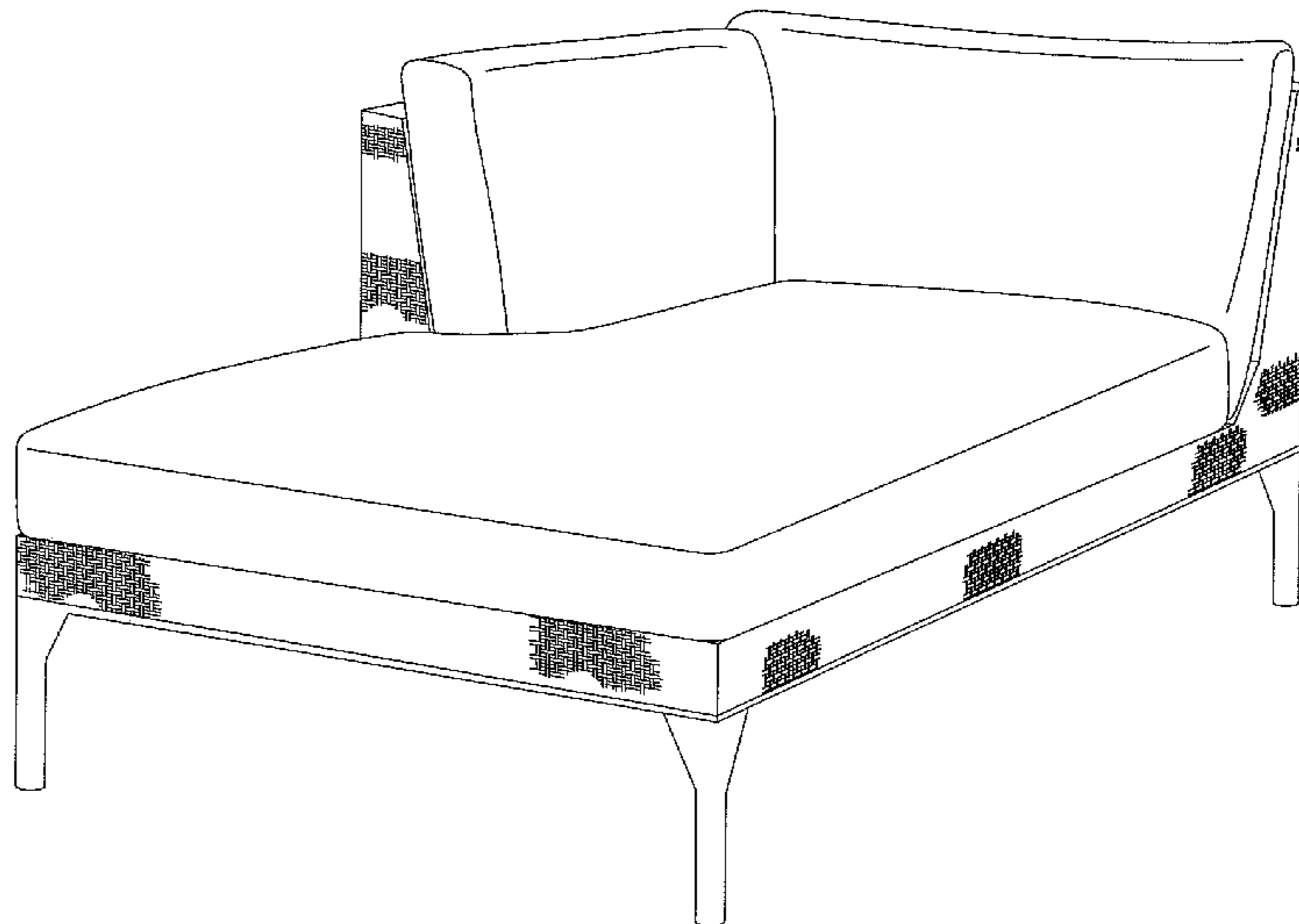

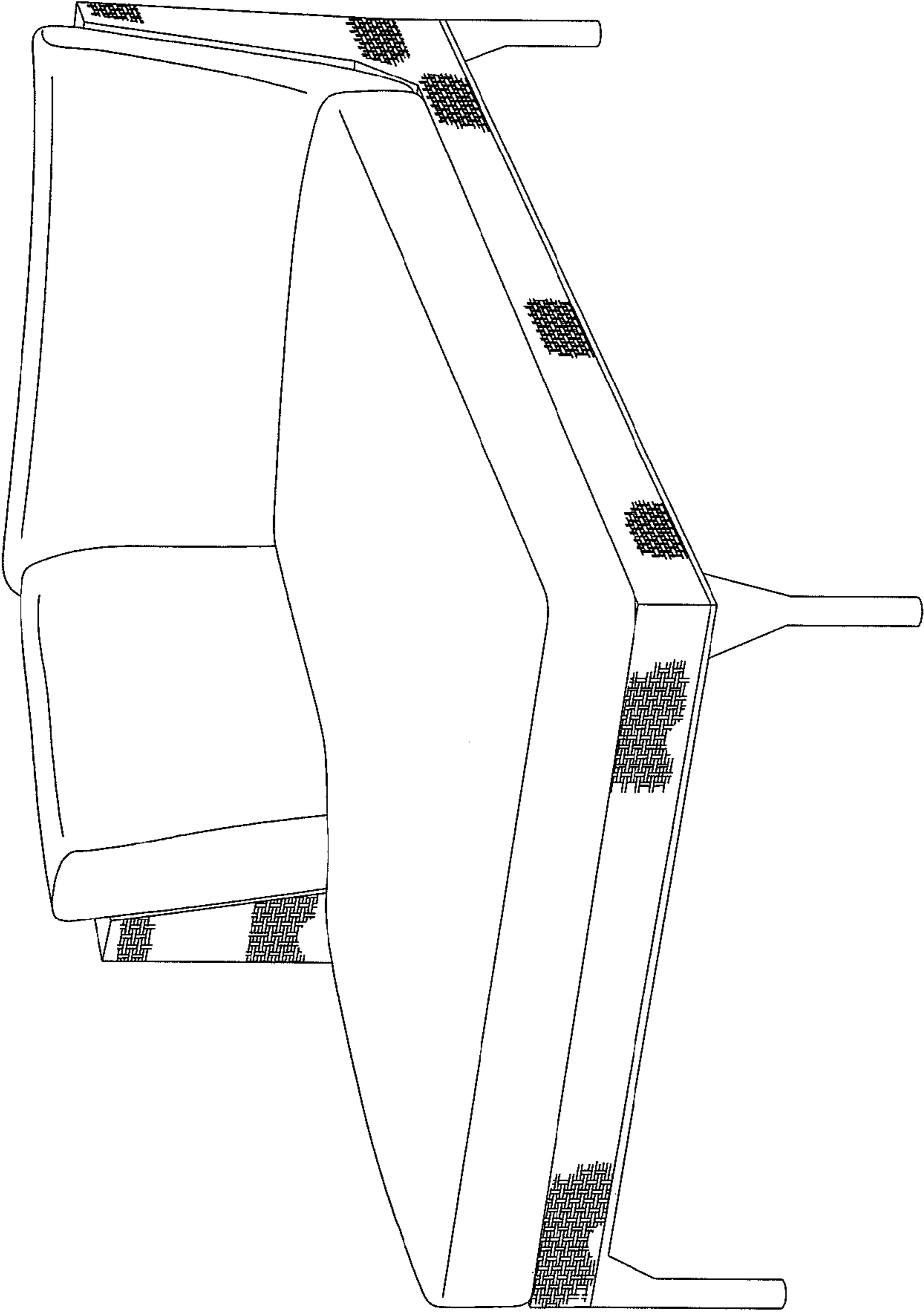

FIG. 1

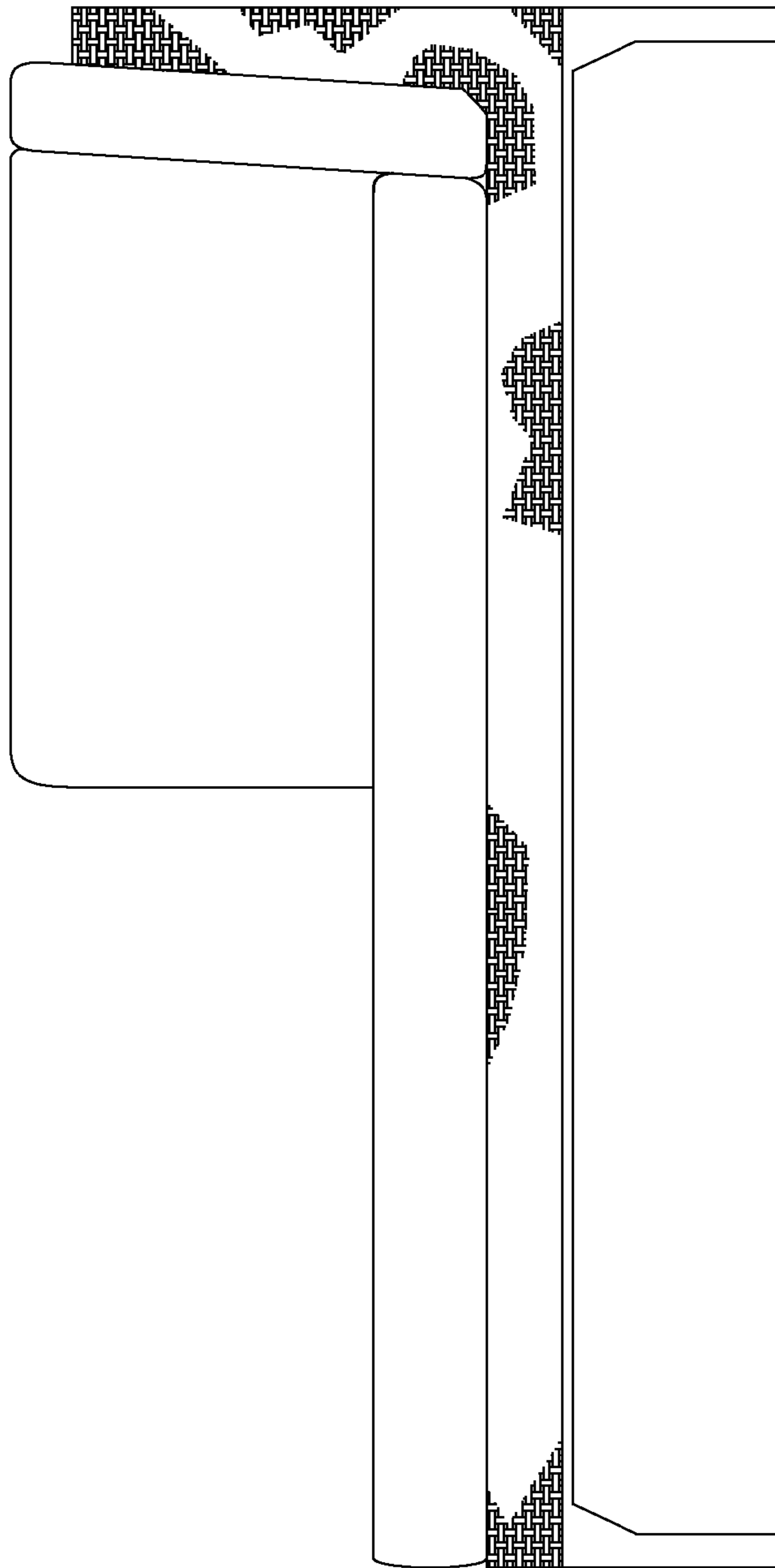

FIG. 2

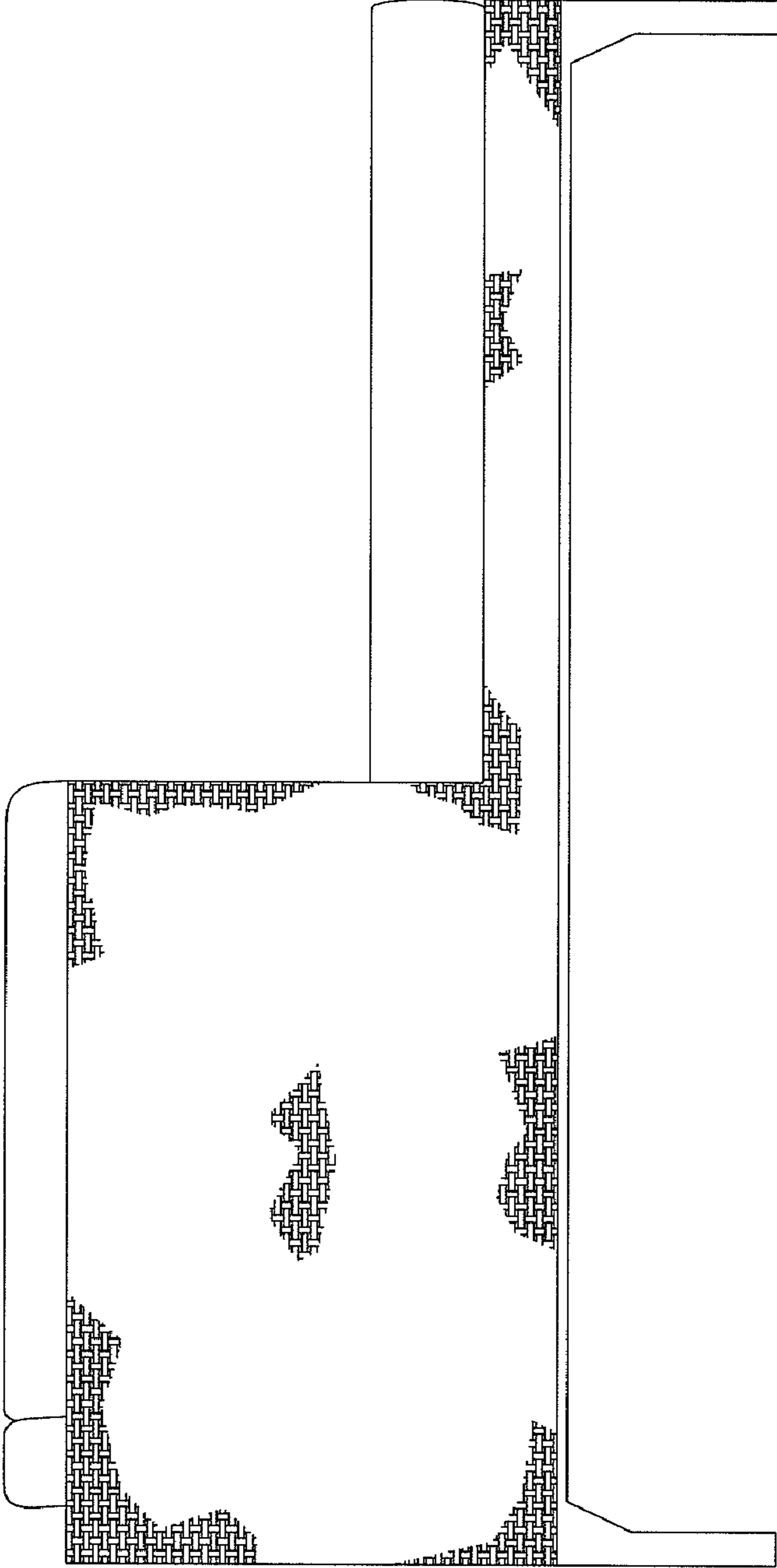

FIG. 3

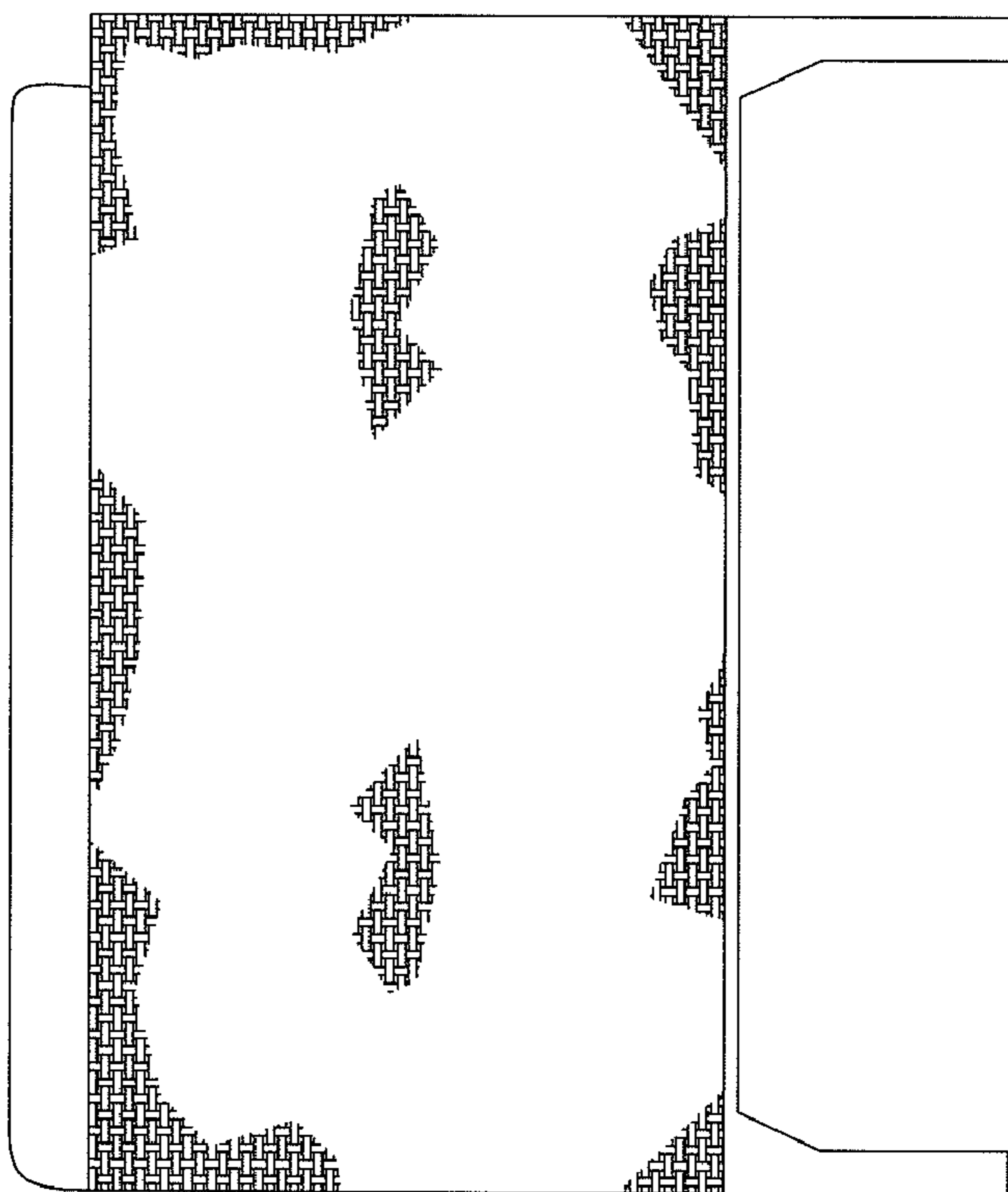

FIG. 5

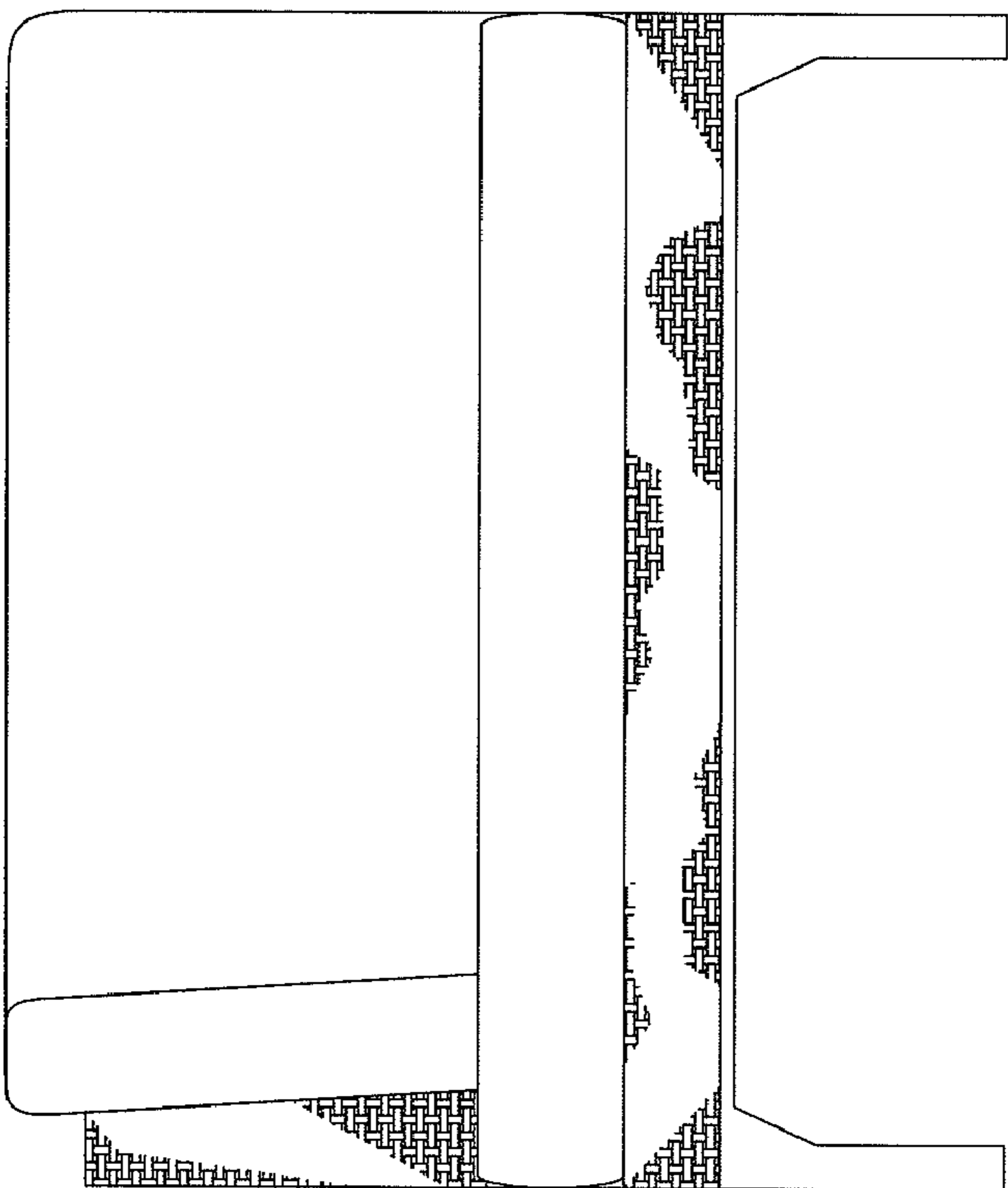

FIG. 4

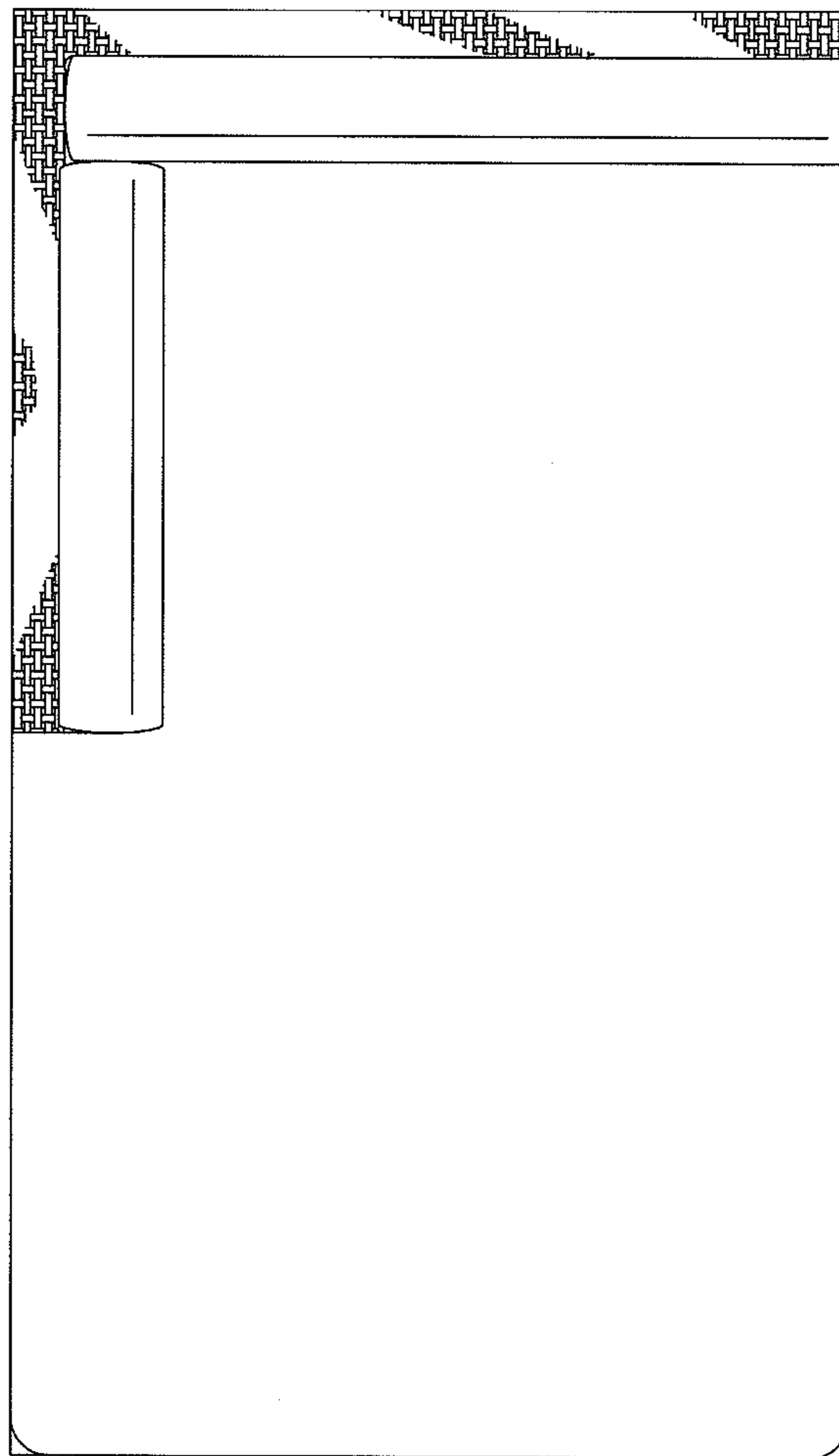

FIG. 6