



US00D660039S

(12) **United States Design Patent**
Grotta et al.

(10) **Patent No.:** **US D660,039 S**

(45) **Date of Patent:** **** May 22, 2012**

(54) **CHAIR**

(75) Inventors: **Stephanie A. Grotta**, Minneapolis, MN (US); **Sara L. Pedersen**, Minneapolis, MN (US); **Daniel J. Hoyord**, St. Paul, MN (US); **Joshua A. Hughes**, Delano, MN (US)

(73) Assignee: **Target Brands, Inc.**, Minneapolis, MN (US)

(**) Term: **14 Years**

(21) Appl. No.: **29/398,378**

(22) Filed: **Jul. 29, 2011**

(51) **LOC (9) Cl.** **06-01**

(52) **U.S. Cl.** **D6/370**

(58) **Field of Classification Search** D6/334,
D6/335, 336, 369, 370, 374, 375, 376, 379,
D6/380, 500-502; 297/239, 445.1, 446.1,
297/452.63

See application file for complete search history.

(56) **References Cited**

U.S. PATENT DOCUMENTS

D292,656 S	*	11/1987	Masterton	D6/370
D338,783 S		8/1993	de Armas		
D359,397 S	*	6/1995	McPhee	D6/370
D366,774 S		2/1996	Frinier		
D399,667 S		10/1998	Muller		
D419,323 S		1/2000	Muller		
D419,791 S	*	2/2000	Schmidt-Bandelow	D6/370
D425,718 S		5/2000	van Valderen		
D446,399 S		8/2001	Slear		
D449,745 S		10/2001	Slear		
D457,342 S		5/2002	Muller		
D498,938 S		11/2004	Kingsley et al.		
D525,799 S		8/2006	Lowsky		
D547,961 S	*	8/2007	Hutton et al.	D6/370
D569,639 S	*	5/2008	Swanson	D6/370
D589,273 S		3/2009	Fairbanks		
D589,274 S		3/2009	Fairbanks		
D591,523 S		5/2009	White, III et al.		
D599,128 S		9/2009	White, III et al.		

OTHER PUBLICATIONS

Gloster Furniture, "Ventura," 1 page, <http://www.gloster.com/us/en/collection/ventura/383/383?print> (last visited on May 23, 2011).

SeatingExpert.com, "Italian Wood Back Side Chair," pp. 1-3, <http://www.seatingexpert.com/Proddet.asp?ProdID=699&category=2&se> (last visited on May 24, 2011).

Nautical Decorator, "Stackable Solid Teak Wood Arm Chair," 1 page, <http://www.nauticaldecorator.com/ivg2/y/productid-25810-stackable-tea...> (last visited on May 24, 2011).

Restoration Hardware, "Santa Monica Armchair," pp. 1-2, <http://www.restorationhardware.com/catalog/product/product.jsp?productId=prod1433058> (last visited on Jul. 28, 2011).

Target, "Smith & Hawken Avignon Teak Chair," pp. 1-3, http://www.target.com/Smith-Hawken-Avignon-Teak-Chair/dp/B0042CRSMK/ref=sr_1_4?ie=UTF8&searchView=grid5&keywords=teak%20chair&fromGsearch=true&sr=1-4&qid=1311877072&rh=&searchRank=target104545&id=Smith%20Hawken%20Avignon%20Teak%20Chair&node=103857611287991011&searchSize=30&searchPage=1&searchNodeID=103857611287991011&searchBinNameList=subjectbin.

Carsmach, "Solid Tropical Hardwood Design Seating Patio Furniture Set Collection," pp. 1-3, <http://carsmach.com/solid-tropical-hardwood-design-seating-patio-furniture-set-collection/outdoor-wooden-armchair-design-seating-furniture/> (last visited May 24, 2011).

* cited by examiner

Primary Examiner — Mimosa De

(74) *Attorney, Agent, or Firm* — Leanne Taveggia Farrell; Westman, Champlin & Kelly, P.A.

(57) **CLAIM**

The ornamental design for a chair, as shown and described.

DESCRIPTION

FIG. 1 is a perspective view of the chair;

FIG. 2 is a front view thereof;

FIG. 3 is a back view thereof;

FIG. 4 is a left side view thereof;

FIG. 5 is a right side view thereof;

FIG. 6 is a top view thereof; and,

FIG. 7 is a bottom view thereof.

The dashed lines in FIGS. 1-7 form no part of the claimed design.

1 Claim, 7 Drawing Sheets

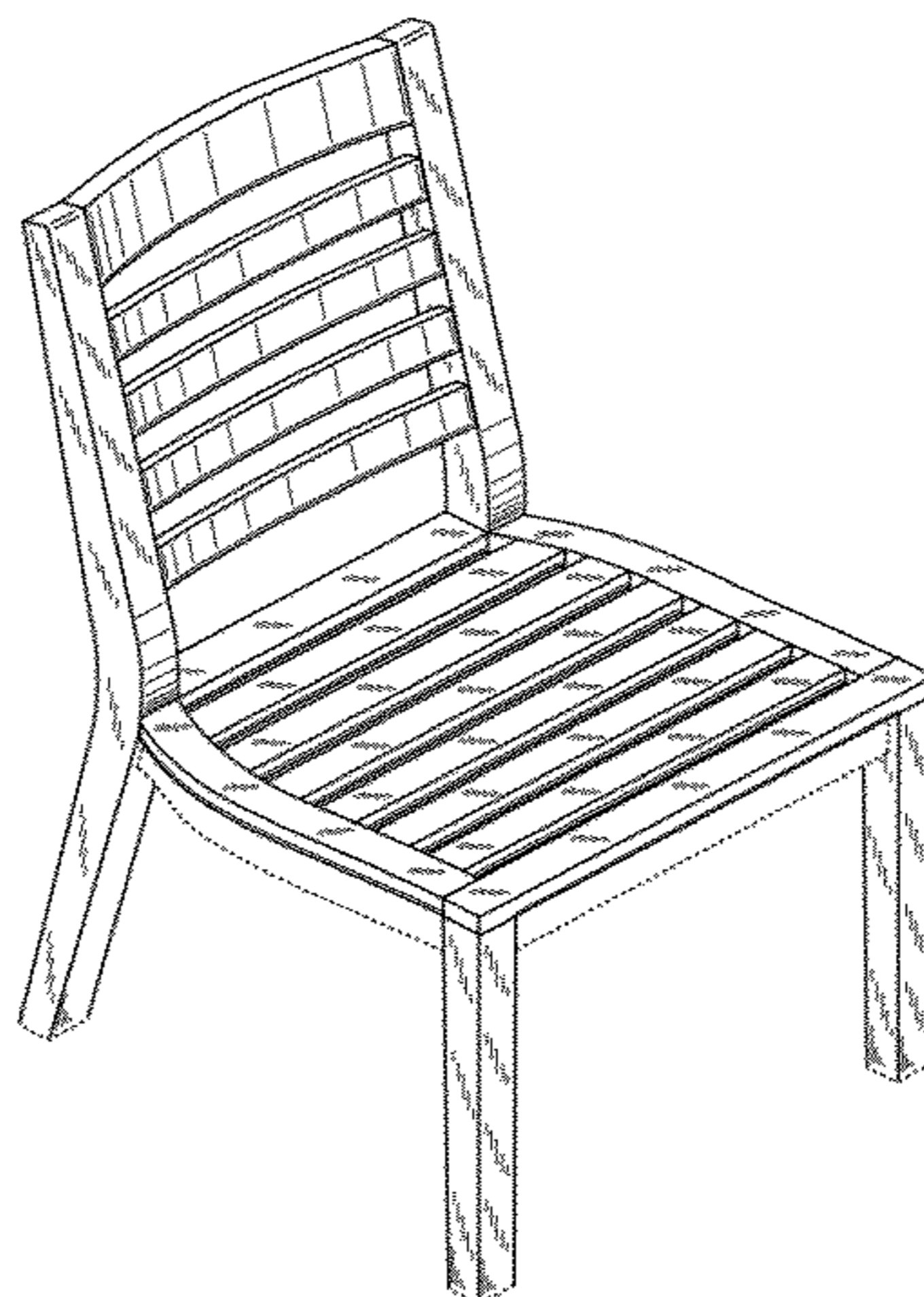

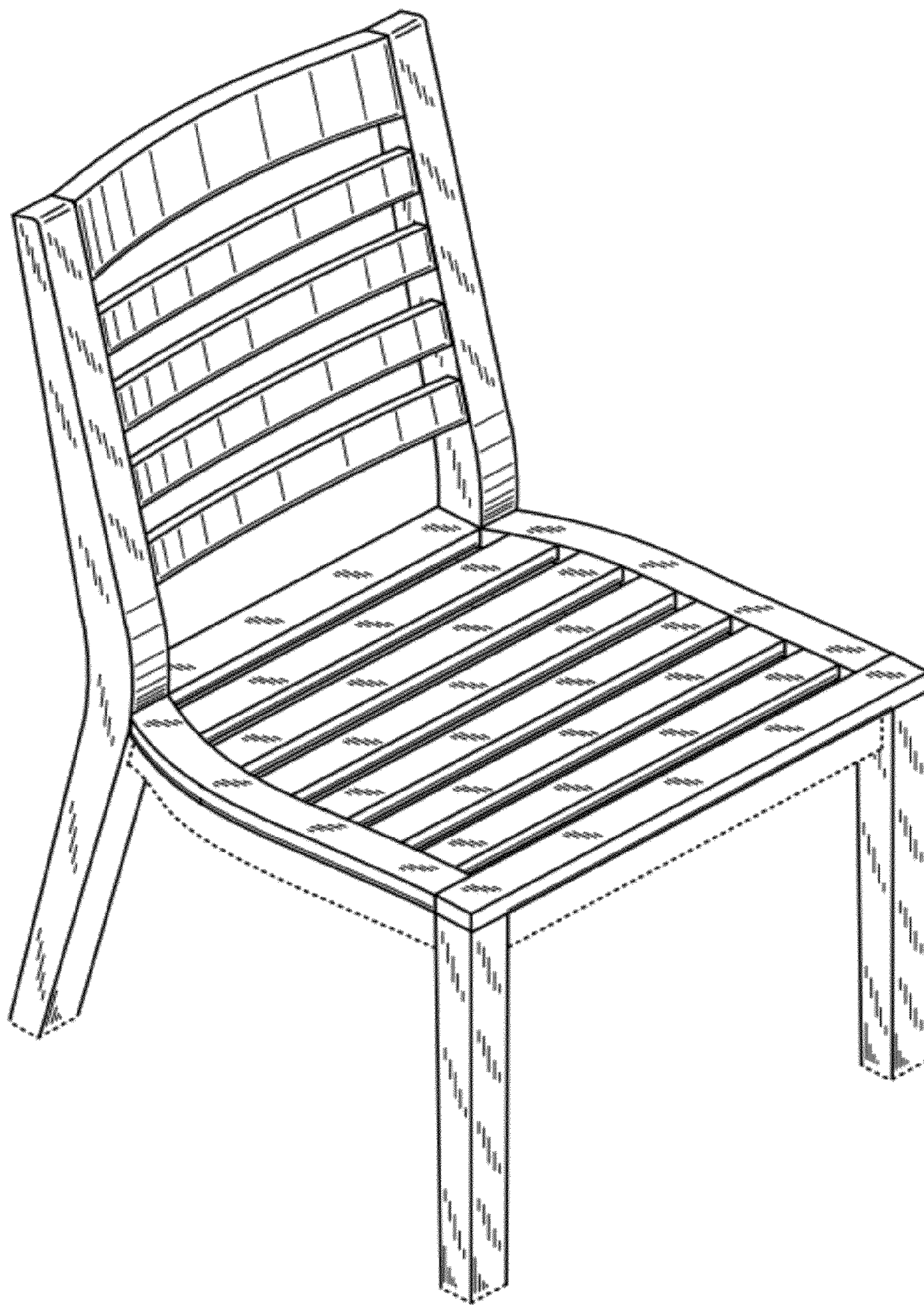

Fig. 1

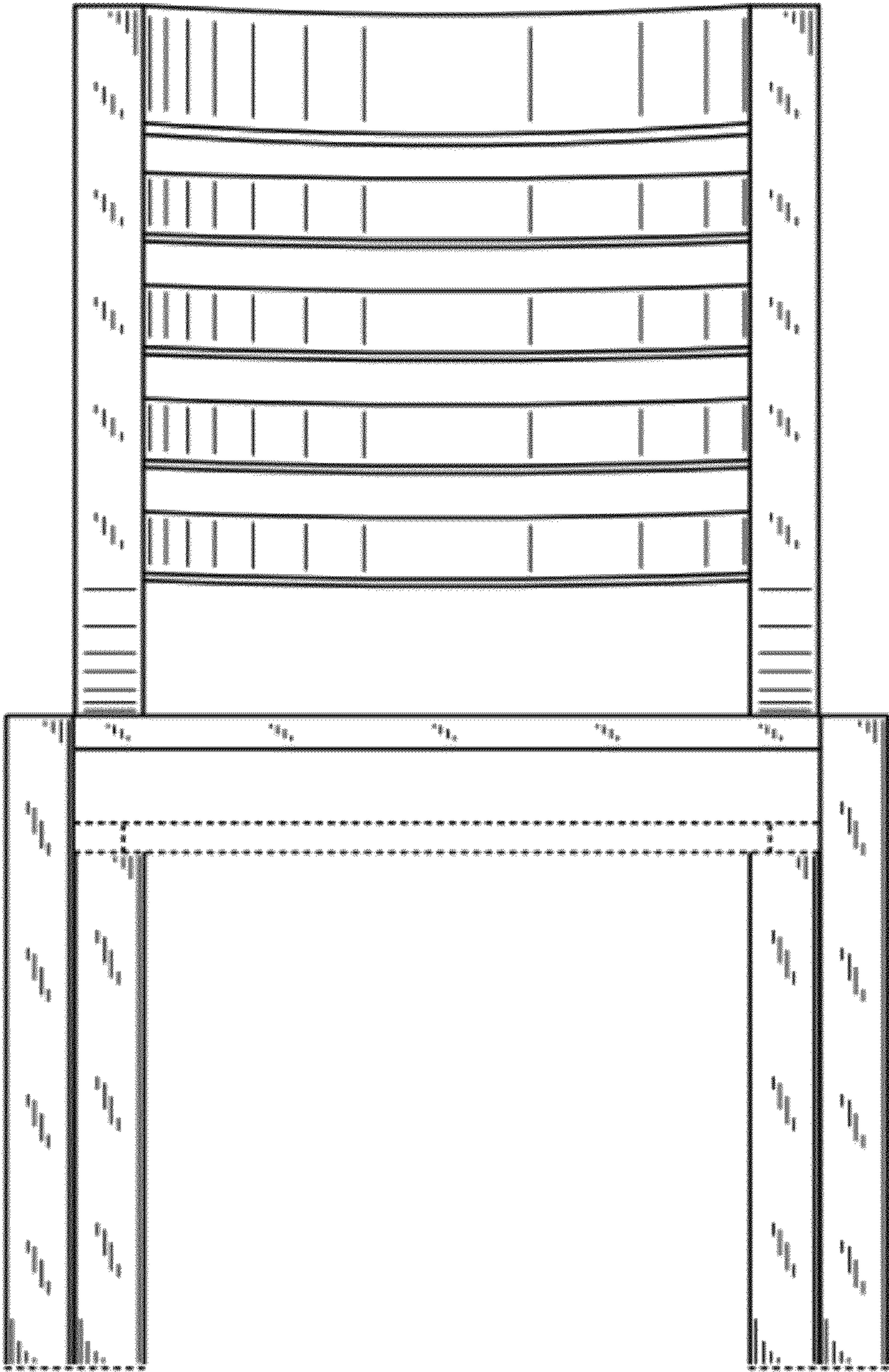

Fig. 2

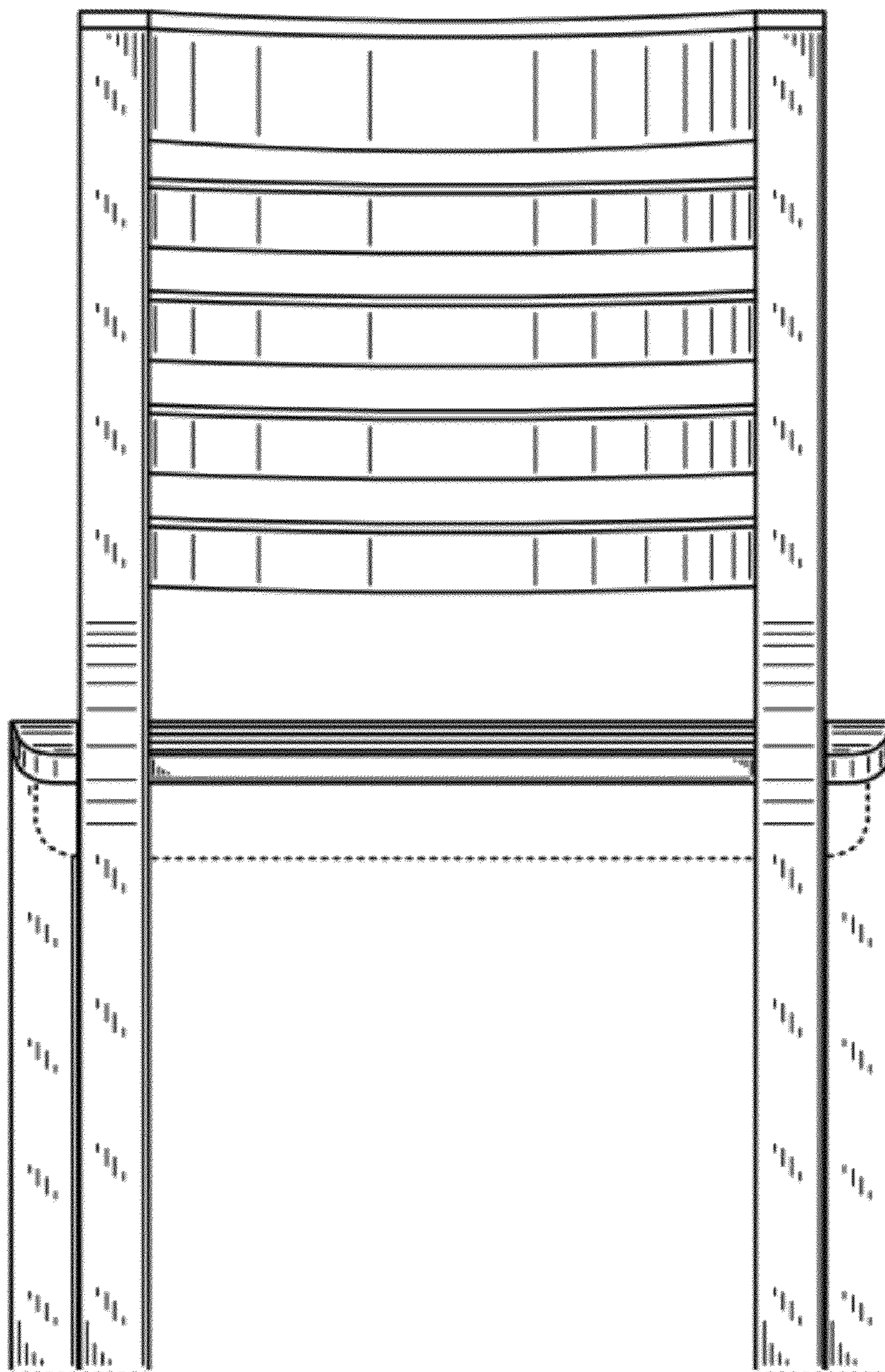

Fig. 3

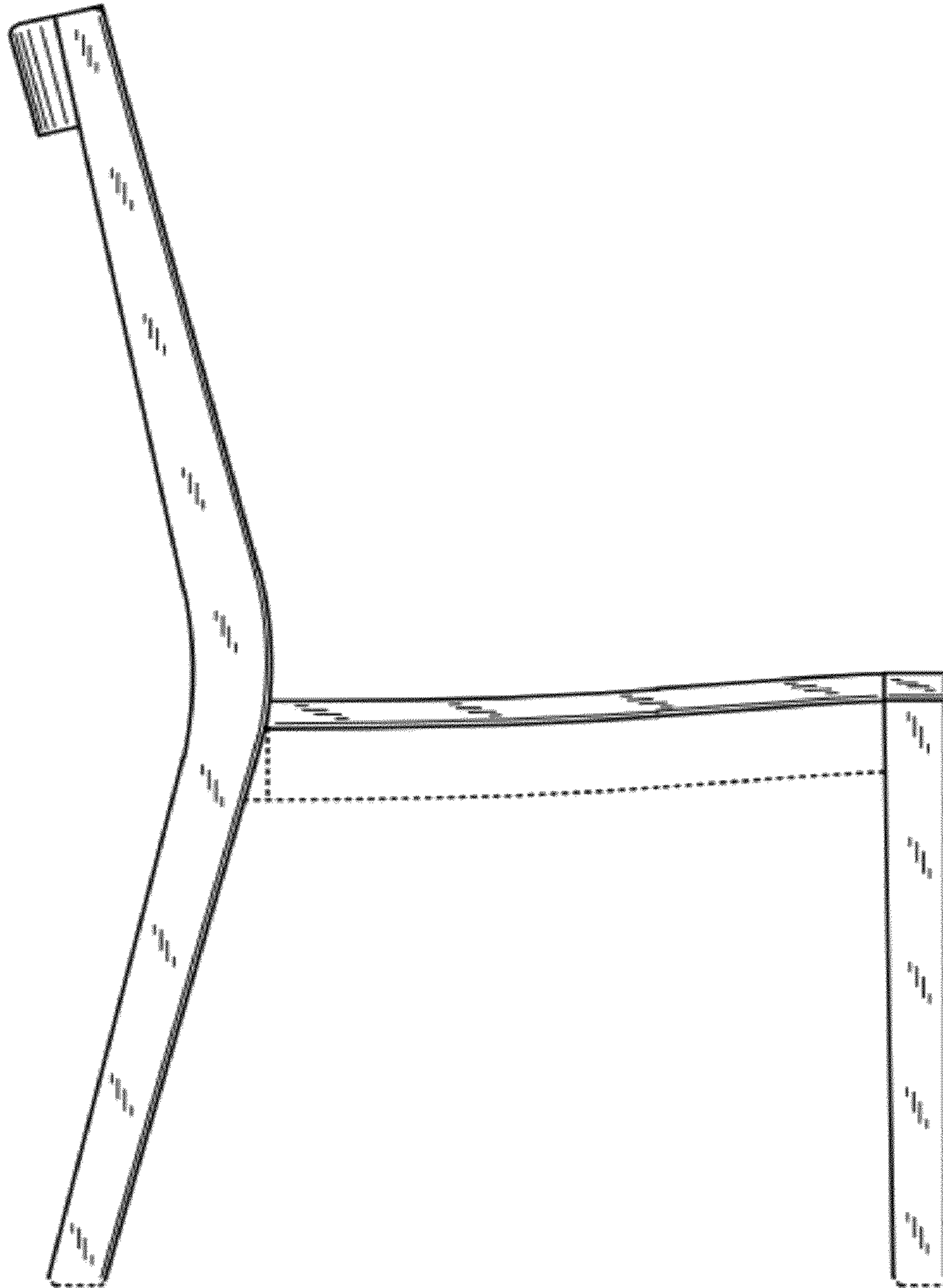

Fig. 4

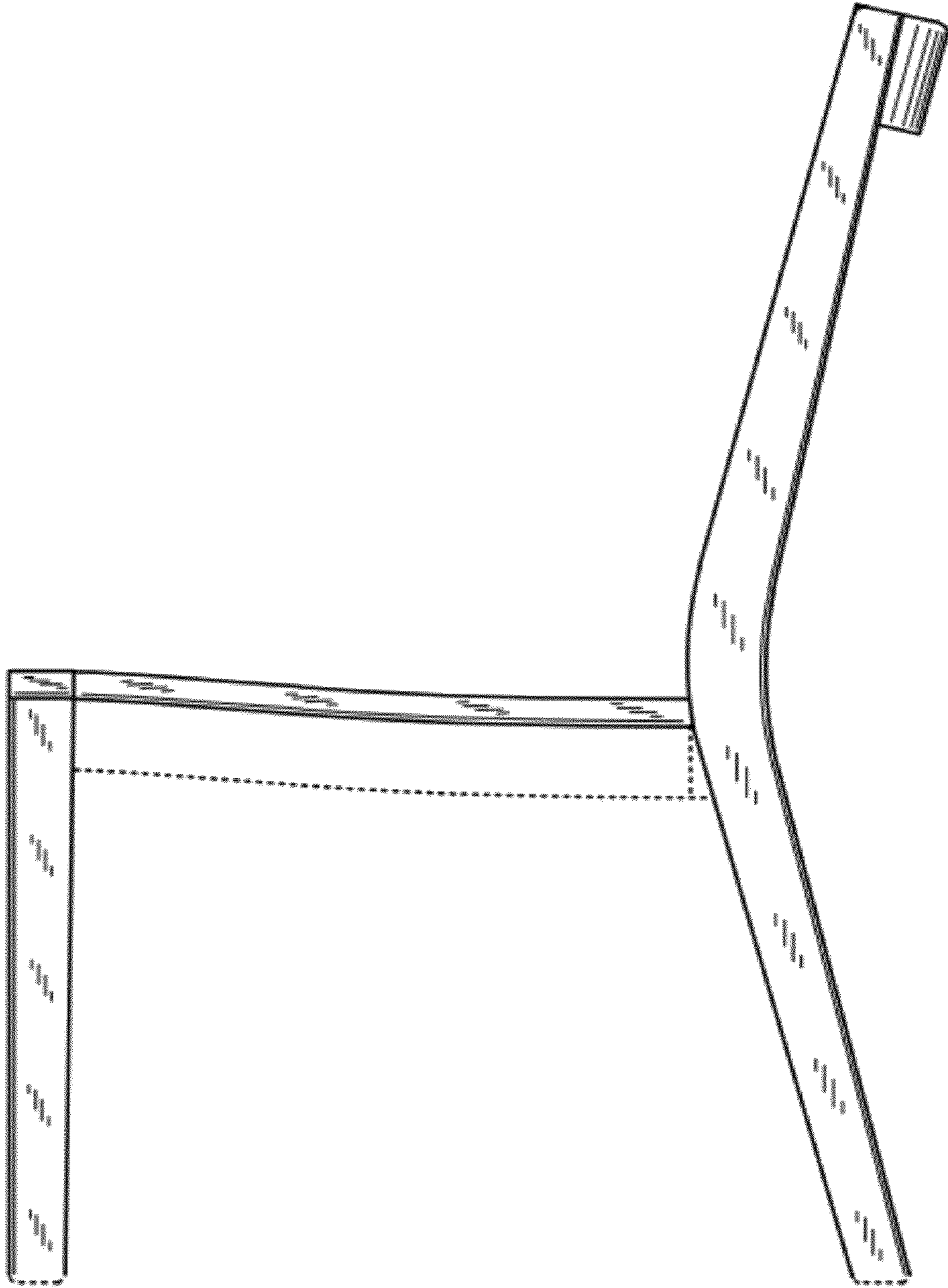

Fig. 5

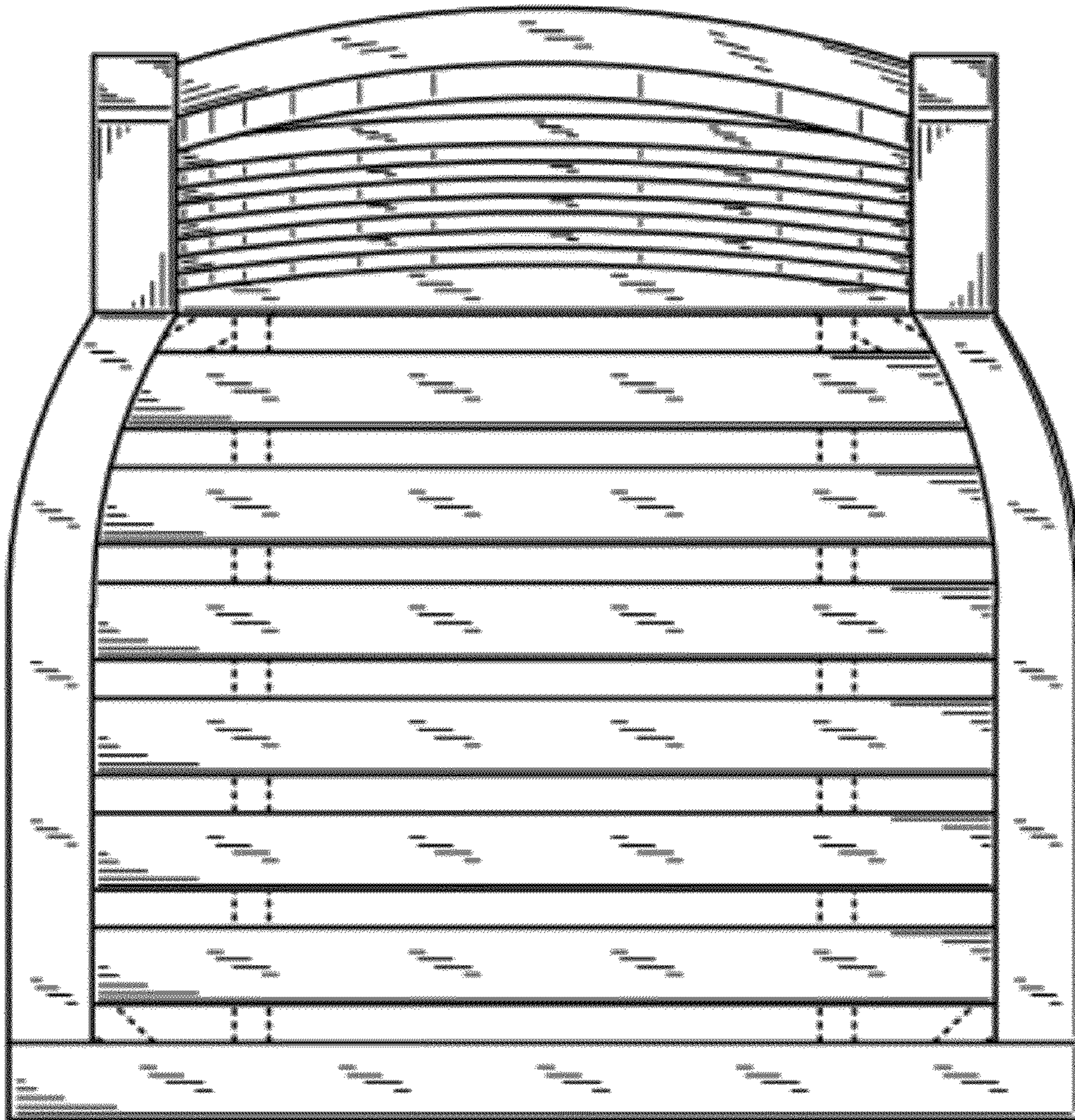

Fig. 6

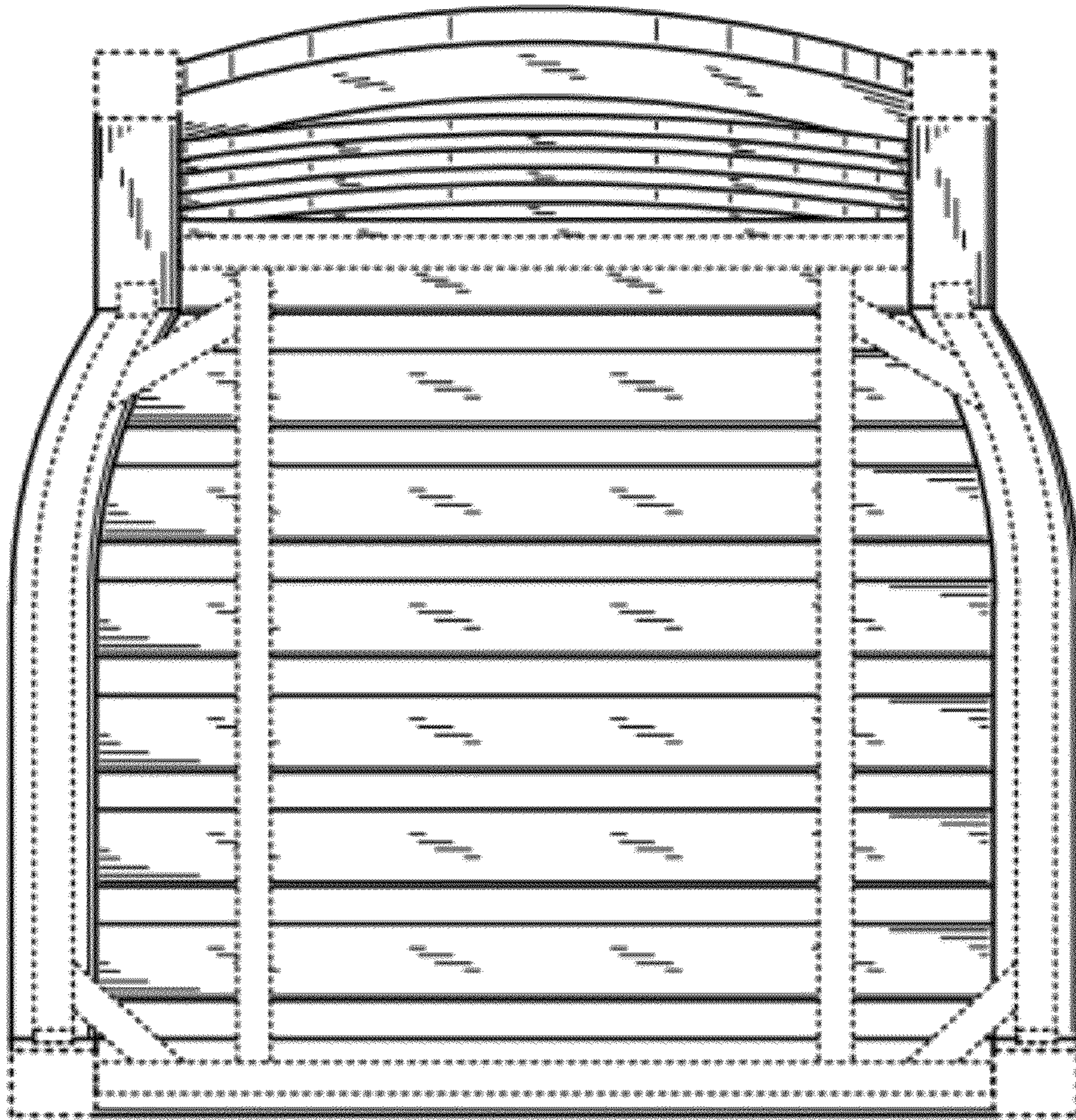

Fig. 7