



US00D659996S

(12) **United States Design Patent**
Fang

(10) **Patent No.:** **US D659,996 S**

(45) **Date of Patent:** **** May 22, 2012**

(54) **TOTE BAG**

(75) Inventor: **Teresa Fang**, Gaffney, SC (US)

(73) Assignee: **Gemini Manufacturing LLC**, Mount Vernon, NY (US)

(**) Term: **14 Years**

(21) Appl. No.: **29/386,968**

(22) Filed: **Mar. 7, 2011**

(51) **LOC (9) Cl.** **08-01**

(52) **U.S. Cl.** **D3/232**

(58) **Field of Classification Search** D3/232–246;
150/100, 103–110, 113–114, 118–119
See application file for complete search history.

(56) **References Cited**

U.S. PATENT DOCUMENTS

D122,628 S *	9/1940	Lewis	D3/240
D232,130 S *	7/1974	Burkett	D3/238
D251,574 S *	4/1979	Molinari et al.	D3/238
D251,575 S *	4/1979	Molinari et al.	D3/238
D260,325 S *	8/1981	Davis	D3/234
D401,761 S *	12/1998	Sandmann et al.	D3/238
D418,975 S *	1/2000	Nastasi	D3/238
D497,250 S *	10/2004	Anderson et al.	D3/238
D579,197 S *	10/2008	Forte	D3/238

D584,506 S * 1/2009 Brazzell D3/234
2007/0130797 A1 * 6/2007 Seamans 36/11.5
* cited by examiner

Primary Examiner — Holly Baynham

(74) *Attorney, Agent, or Firm* — Scott D. Wofsy; David I. Greenbaum; Edwards Wildman Palmer LLP

(57) **CLAIM**

The ornamental design for a tote bag, as shown and described.

DESCRIPTION

FIG. 1 is a perspective view of an embodiment of a tote bag of the subject invention;
FIG. 2 is a front plan view of the tote bag of FIG. 1;
FIG. 3 is a back plan view of the tote bag of FIG. 1;
FIG. 4 is left side view of the tote bag of FIG. 1;
FIG. 5 is right side view of the tote bag of FIG. 1;
FIG. 6 is a top view of the tote bag of FIG. 1;
FIG. 7 is a bottom view of the tote bag of FIG. 1;
FIG. 8 is a perspective view of another embodiment of the tote bag as shown in FIG. 1;
FIG. 9 is a front plan view of the tote bag of FIG. 8;
FIG. 10 is a back plan view of the tote bag of FIG. 8;
FIG. 11 is left side view of the tote bag of FIG. 8;
FIG. 12 is right side view of the tote bag of FIG. 8;
FIG. 13 is a top view of the tote bag of FIG. 8; and,
FIG. 14 is a bottom view of the tote bag of FIG. 8.
The broken lines showing stitching are for the purposes of illustrating environment and form no part of the claimed design.

1 Claim, 10 Drawing Sheets

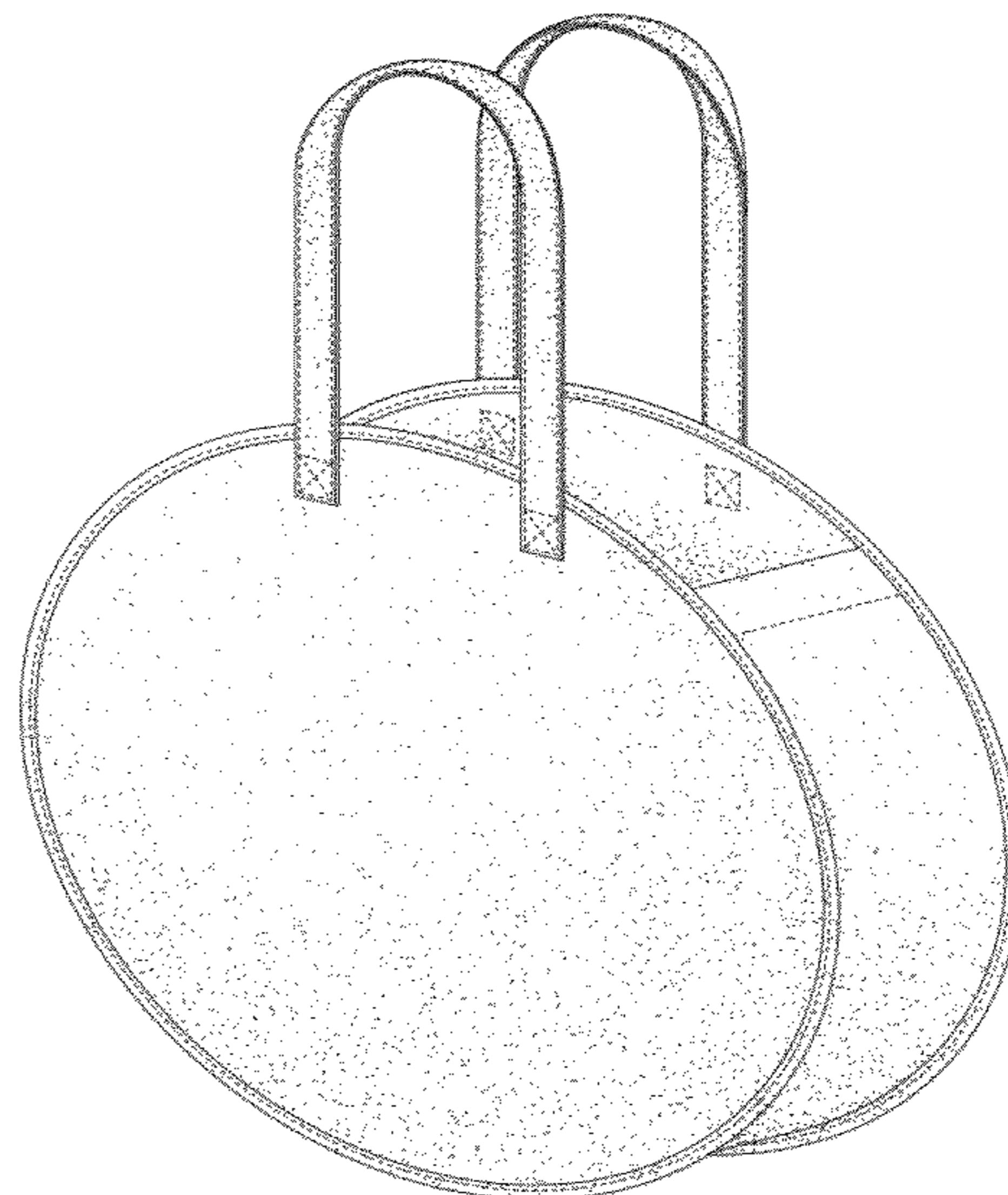
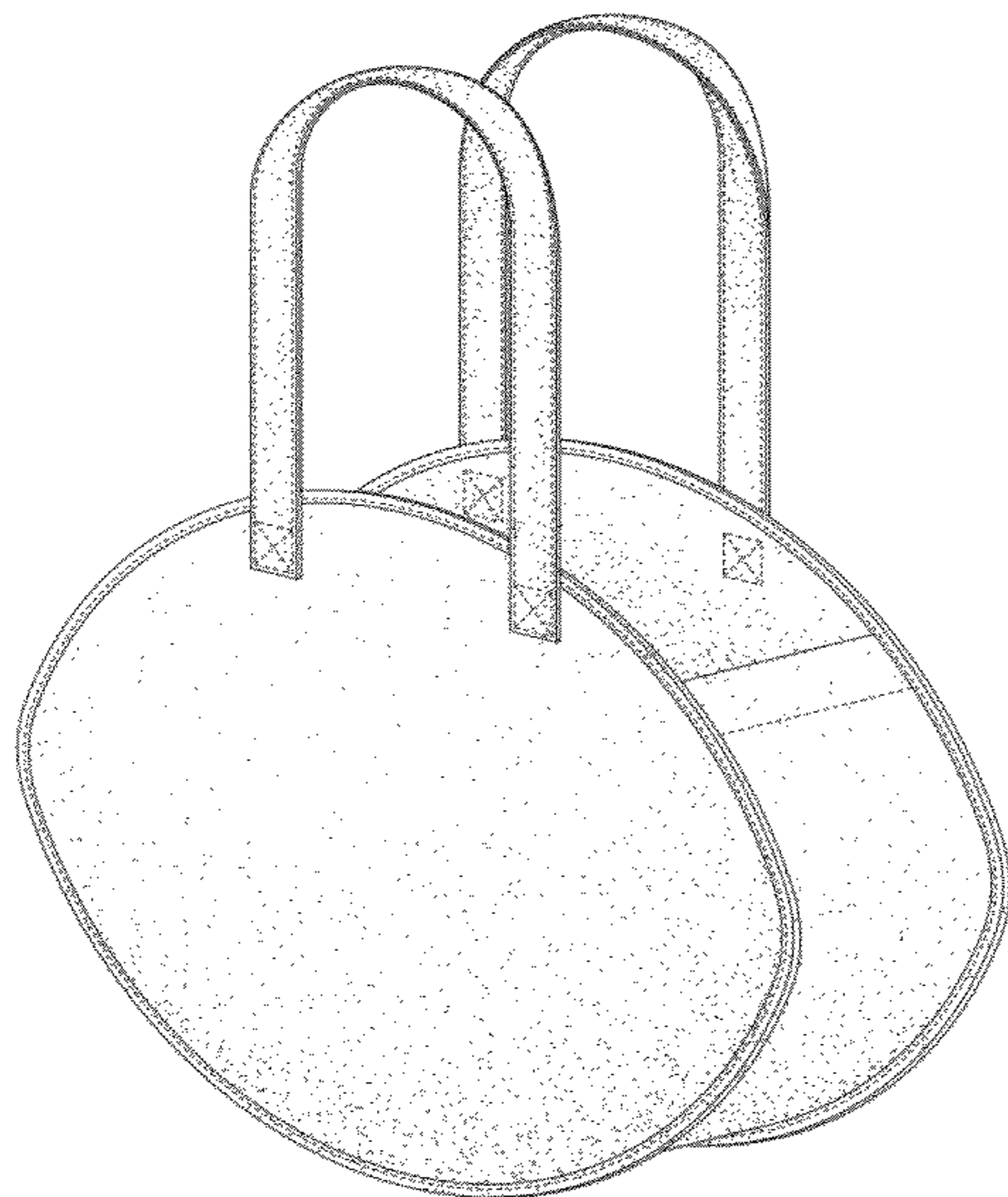

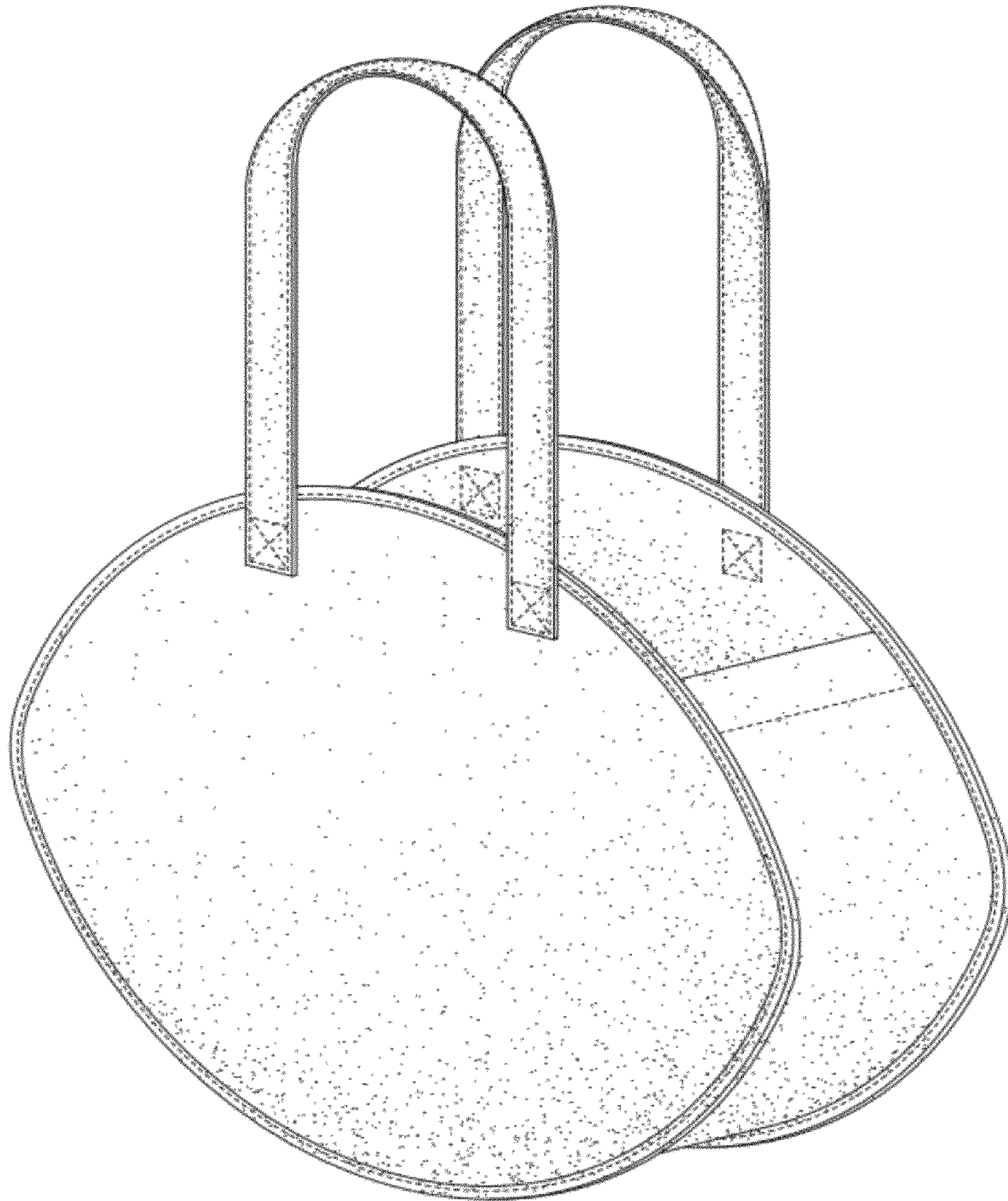

FIG. 1

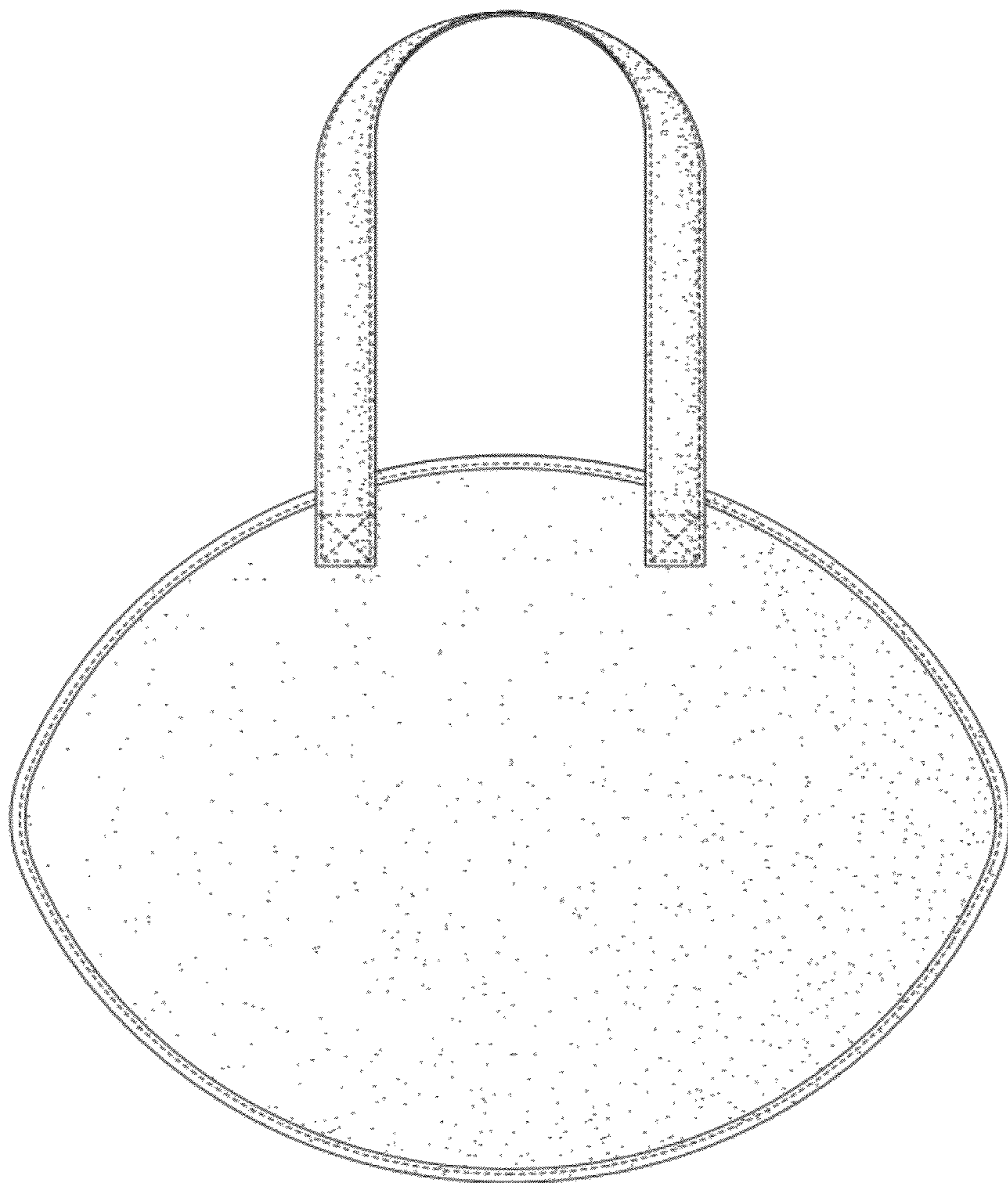

FIG. 2

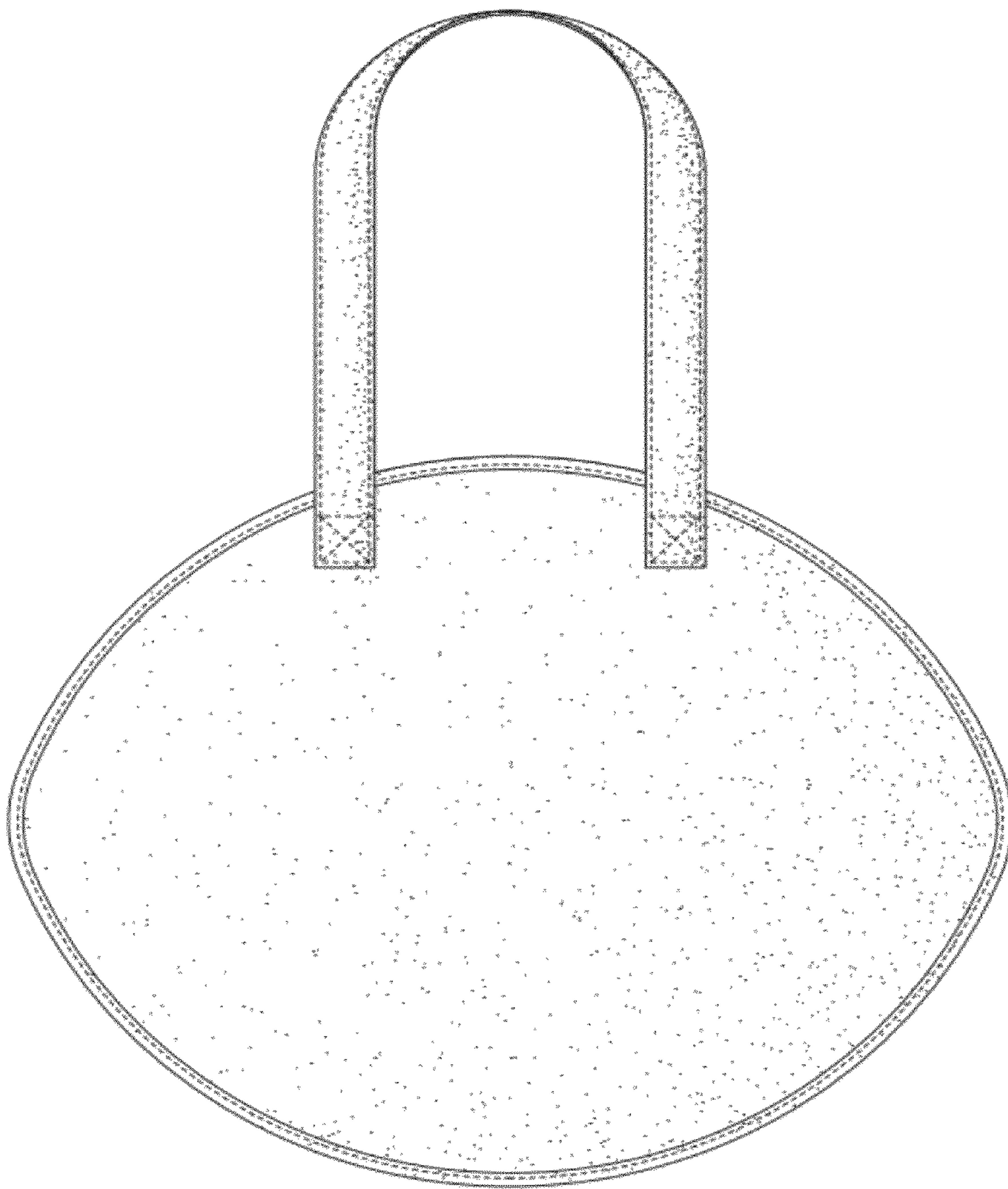

FIG. 3

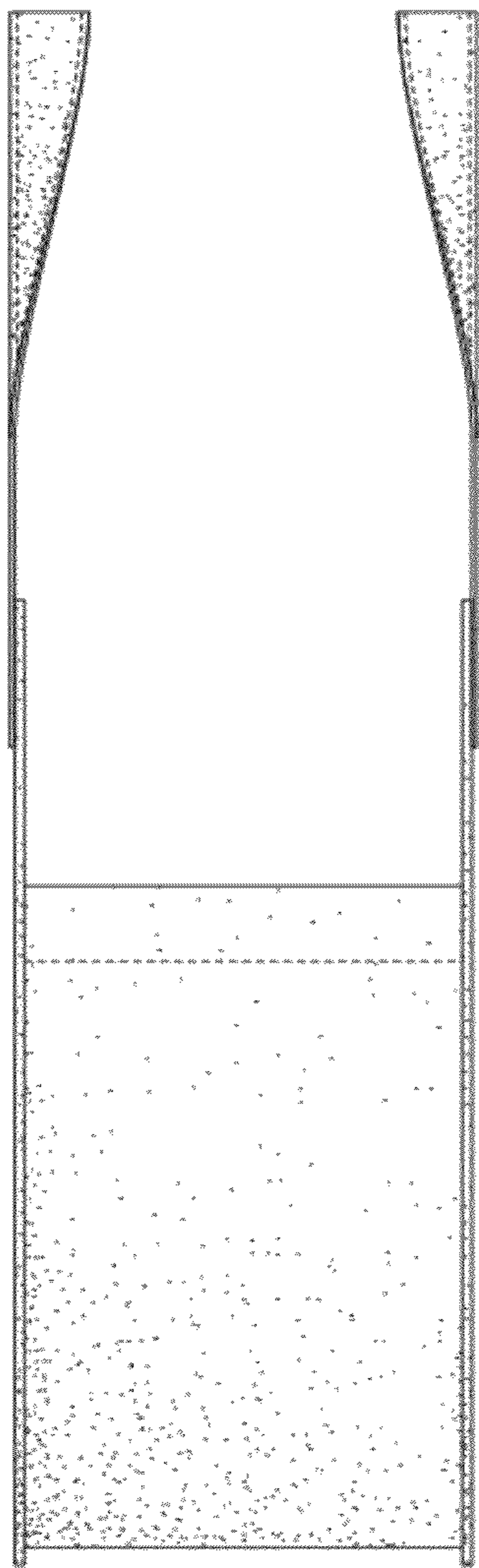

FIG. 4

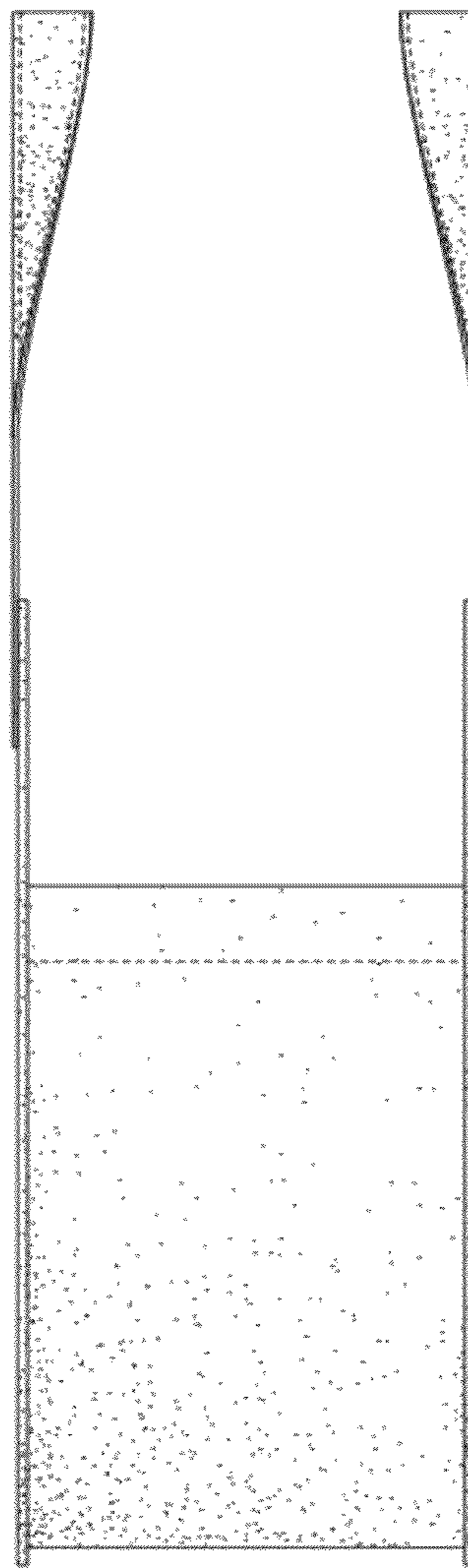

FIG. 5

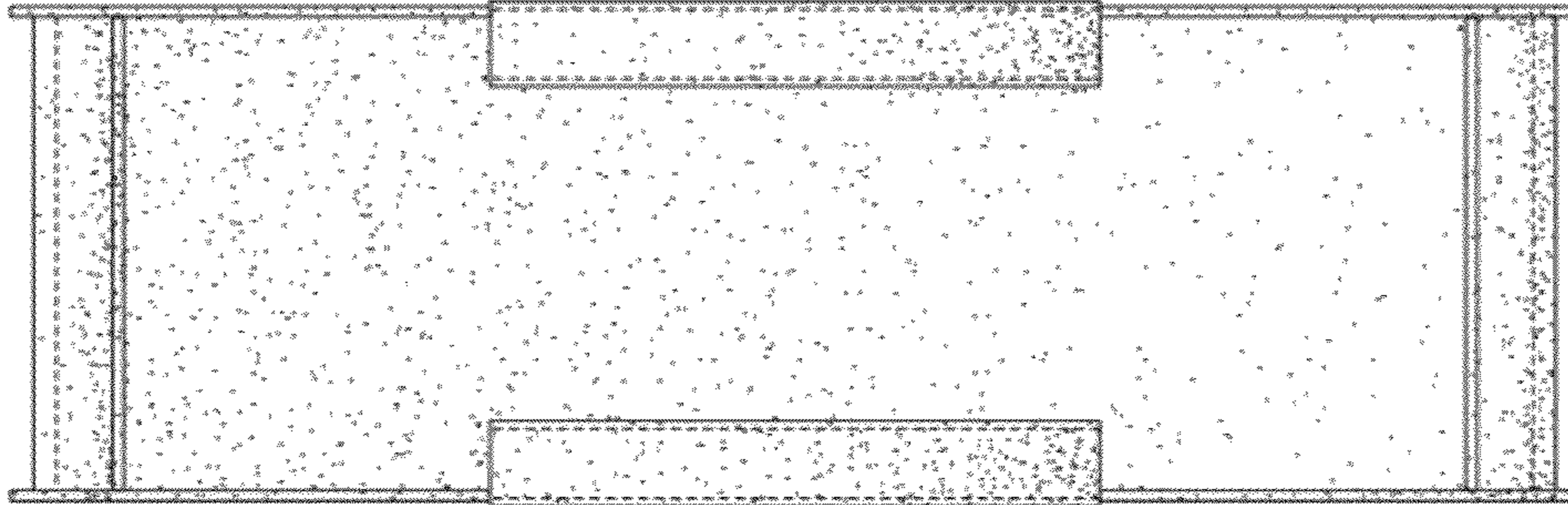

FIG. 6

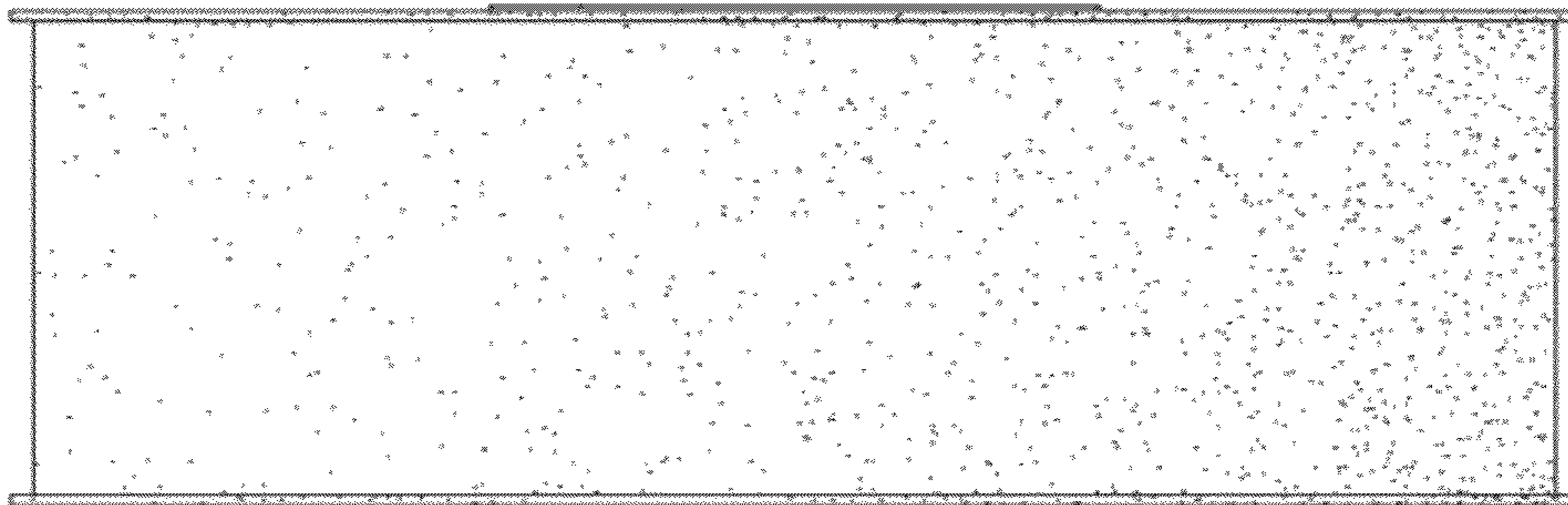

FIG. 7

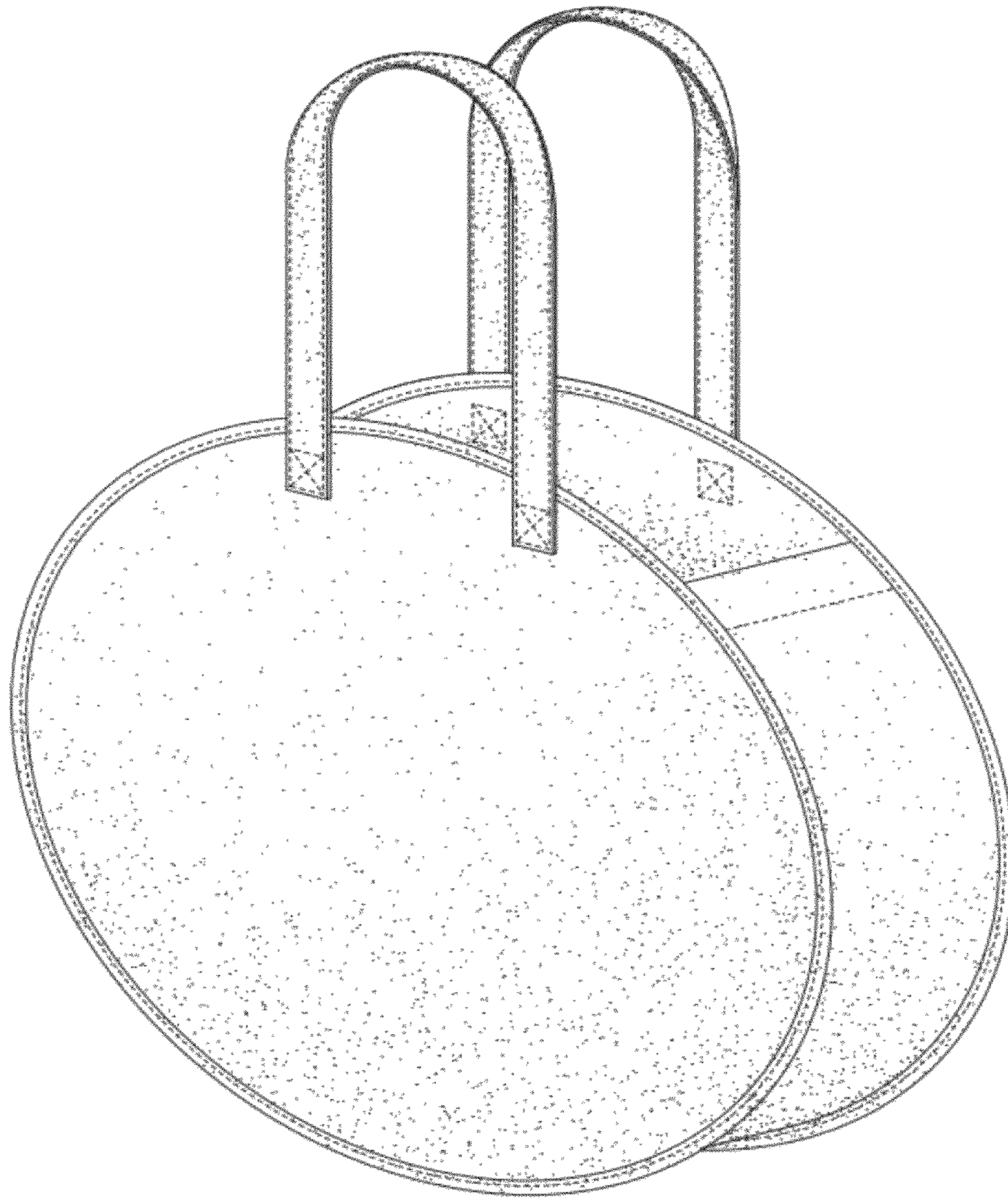

FIG. 8

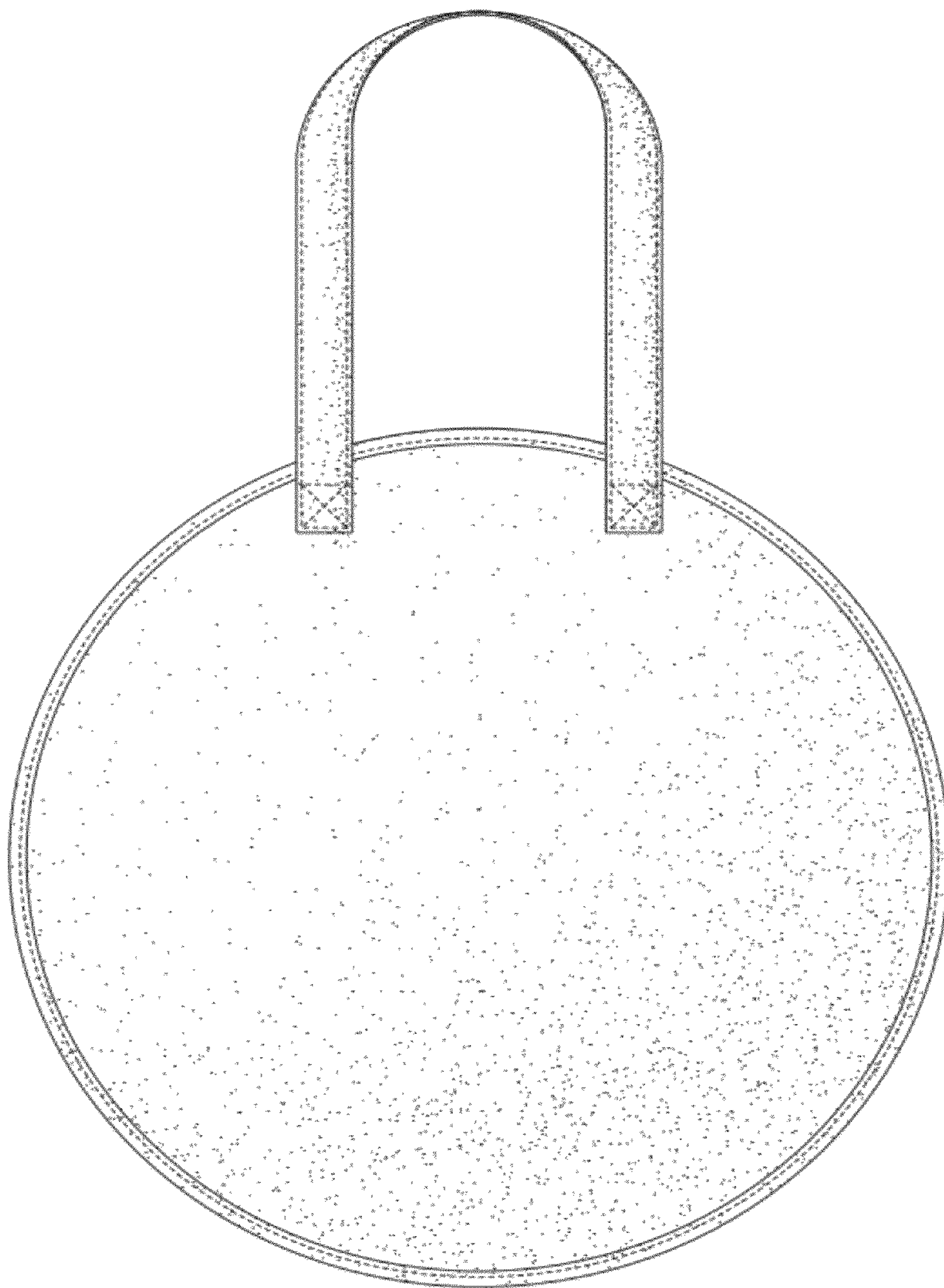

FIG. 9

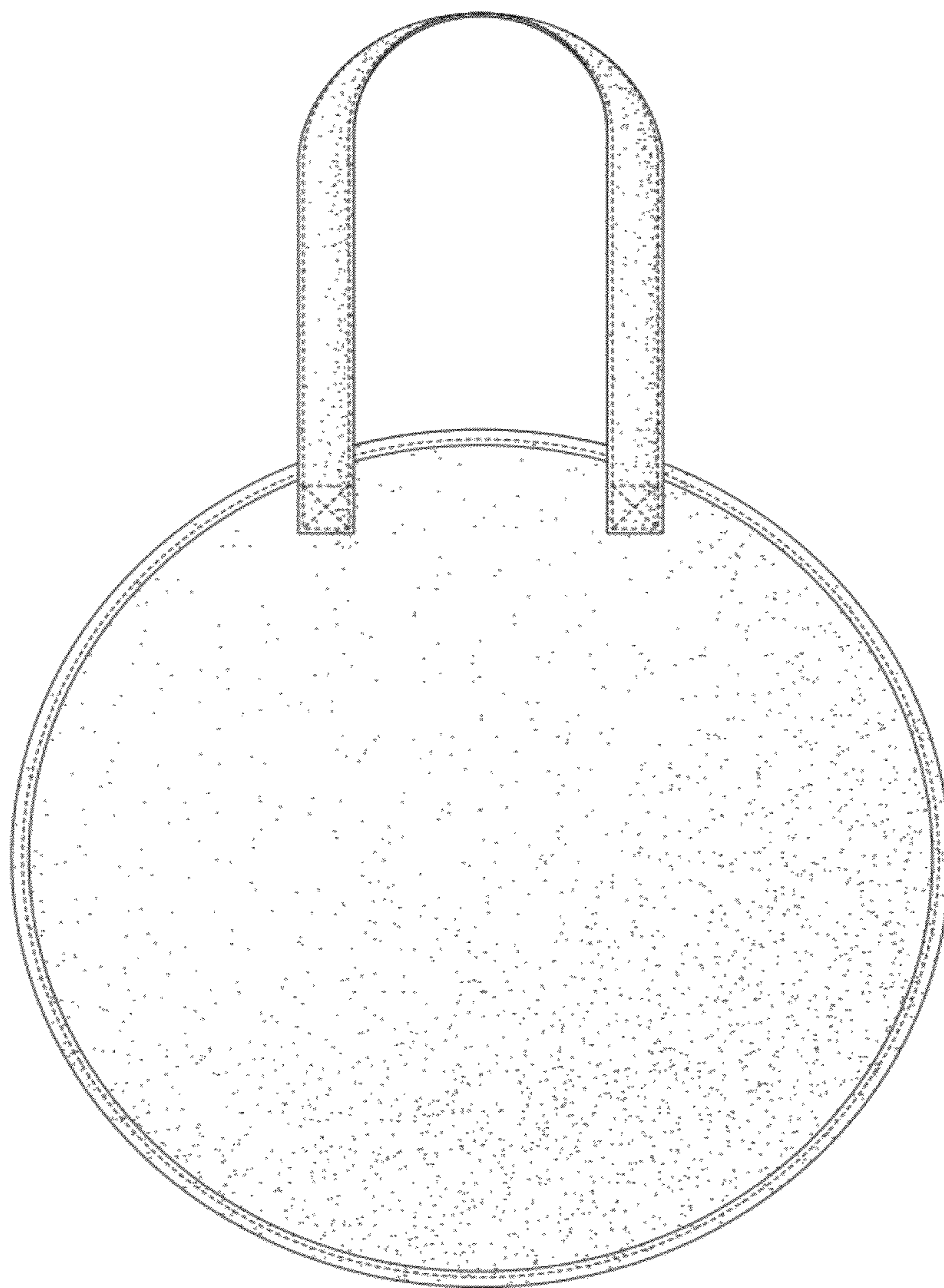

FIG. 10

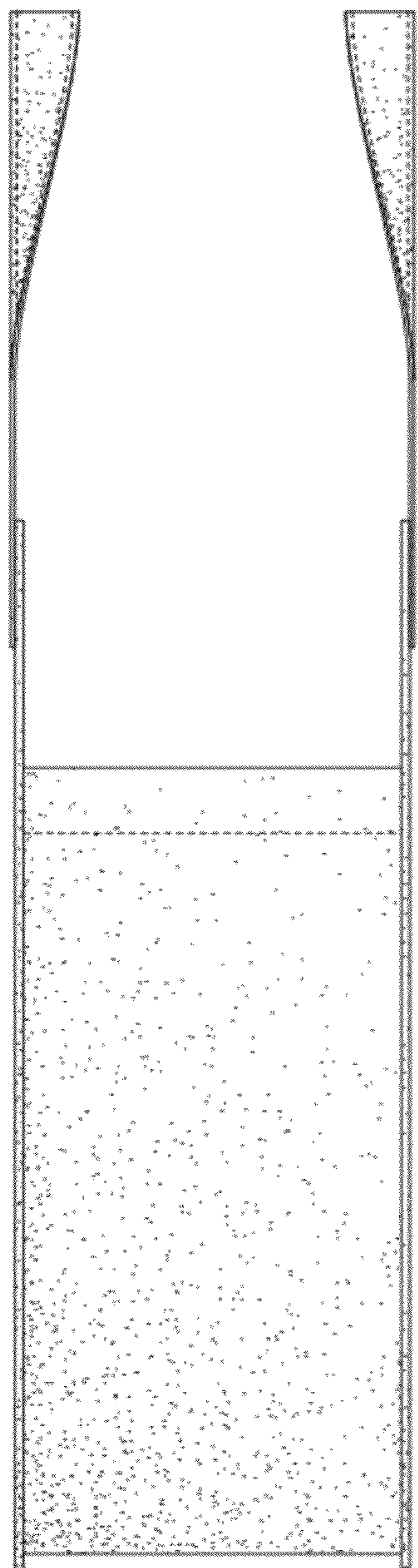

FIG. 11

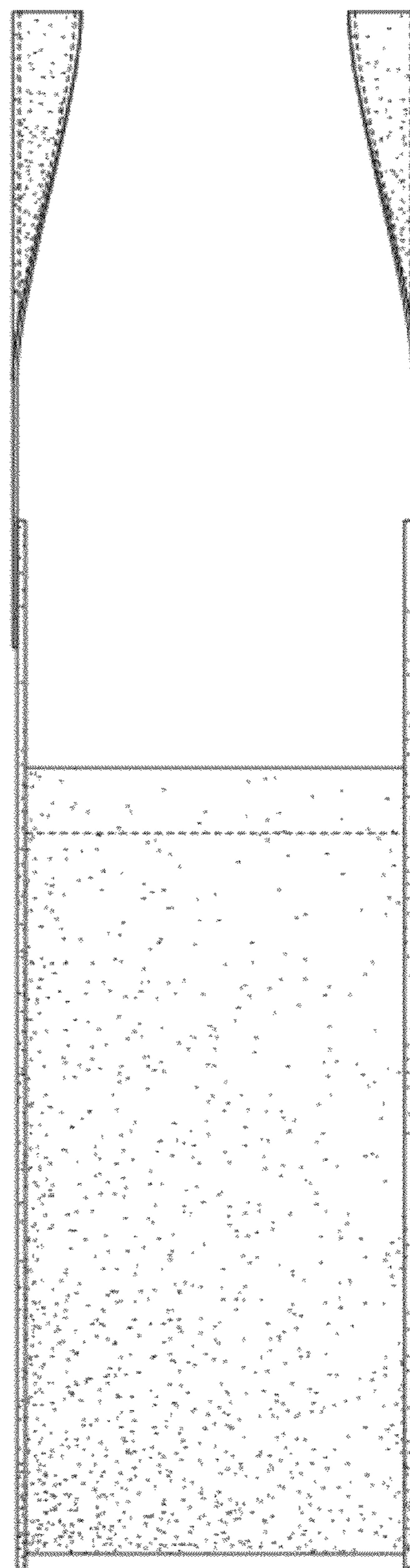

FIG. 12

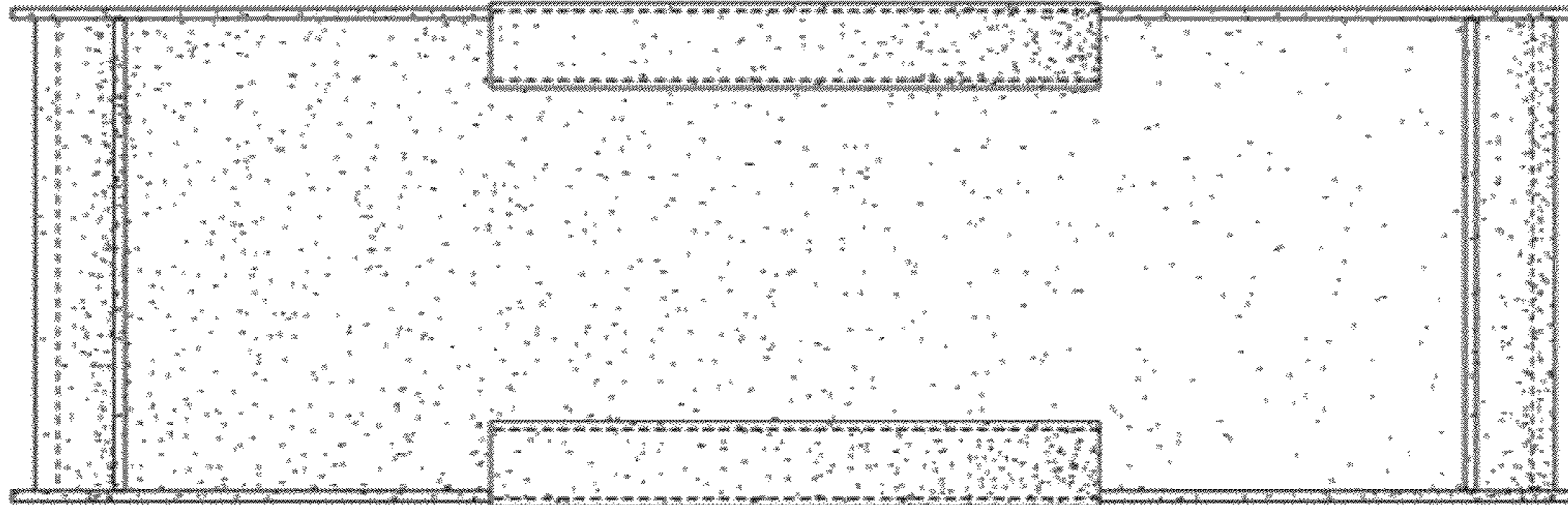

FIG. 13

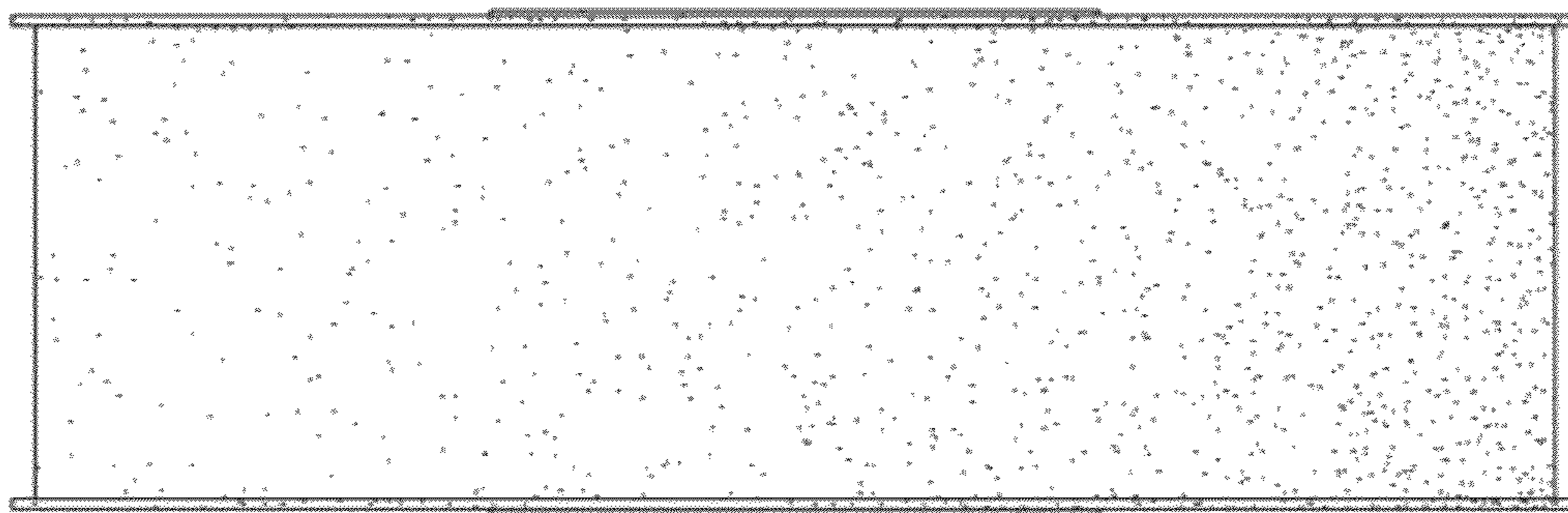

FIG. 14