



US00D659942S

(12) **United States Design Patent**
Tretchell

(10) **Patent No.:** **US D659,942 S**

(45) **Date of Patent:** **** May 15, 2012**

(54) **STORAGE CONTAINER**

(76) Inventor: **Wayne J. Tretchell**, Dothan, AL (US)

(**) Term: **14 Years**

(21) Appl. No.: **29/372,776**

(22) Filed: **Jan. 11, 2011**

(51) **LOC (9) Cl.** **99-00**

(52) **U.S. Cl.** **D99/1**

(58) **Field of Classification Search** D99/1,
D99/3, 5, 17, 30, 37; 27/1, 2, 4, 7; 52/103;
D9/600

See application file for complete search history.

(56) **References Cited**

U.S. PATENT DOCUMENTS

30,292	A *	10/1860	Brubach	27/2
212,273	A *	2/1879	Shannon	27/1
258,161	A *	5/1882	Van Dusen	27/3
D37,581	S *	10/1905	Ellis	D27/110
1,270,543	A *	6/1918	Navarrete et al.	27/7
D56,919	S *	1/1921	Gordon	D99/37
D163,837	S	7/1951	Waldron	
3,525,132	A *	8/1970	Gauchard	27/19
4,212,386	A *	7/1980	Maisonneuve	206/37
4,517,713	A *	5/1985	Swallert	27/4
4,854,018	A *	8/1989	Von Bratt	27/19
4,891,869	A *	1/1990	Nutting	27/4
D313,745	S *	1/1991	Akman	D9/600

5,111,559	A *	5/1992	Mohr et al.	27/4
D407,179	S *	3/1999	Curtis	D99/1
D419,260	S *	1/2000	Manzo, Jr.	D27/188
D432,285	S *	10/2000	Baldwin et al.	D99/5
6,370,744	B1	4/2002	Mendez	
D531,780	S *	11/2006	Nutting	D99/3
D551,825	S *	9/2007	Nutting	D99/3

* cited by examiner

Primary Examiner — Paula Greene

(74) *Attorney, Agent, or Firm* — Paul R. Martin

(57) **CLAIM**

The ornamental design for a storage container, as shown and described.

DESCRIPTION

FIG. 1 is a perspective view of my new design for a storage container.

FIG. 2 is another perspective view of my new design for a storage container showing the lid in open position.

FIG. 3 is a top plan view of the storage container shown in FIG. 1.

FIG. 4 is a right side elevational view thereof.

FIG. 5 is a left side elevational view thereof.

FIG. 6 is a front elevational view thereof.

FIG. 7 is a rear elevational view thereof; and,

FIG. 8 is a bottom plan view thereof.

The broken lines form no part of the claimed design.

1 Claim, 5 Drawing Sheets

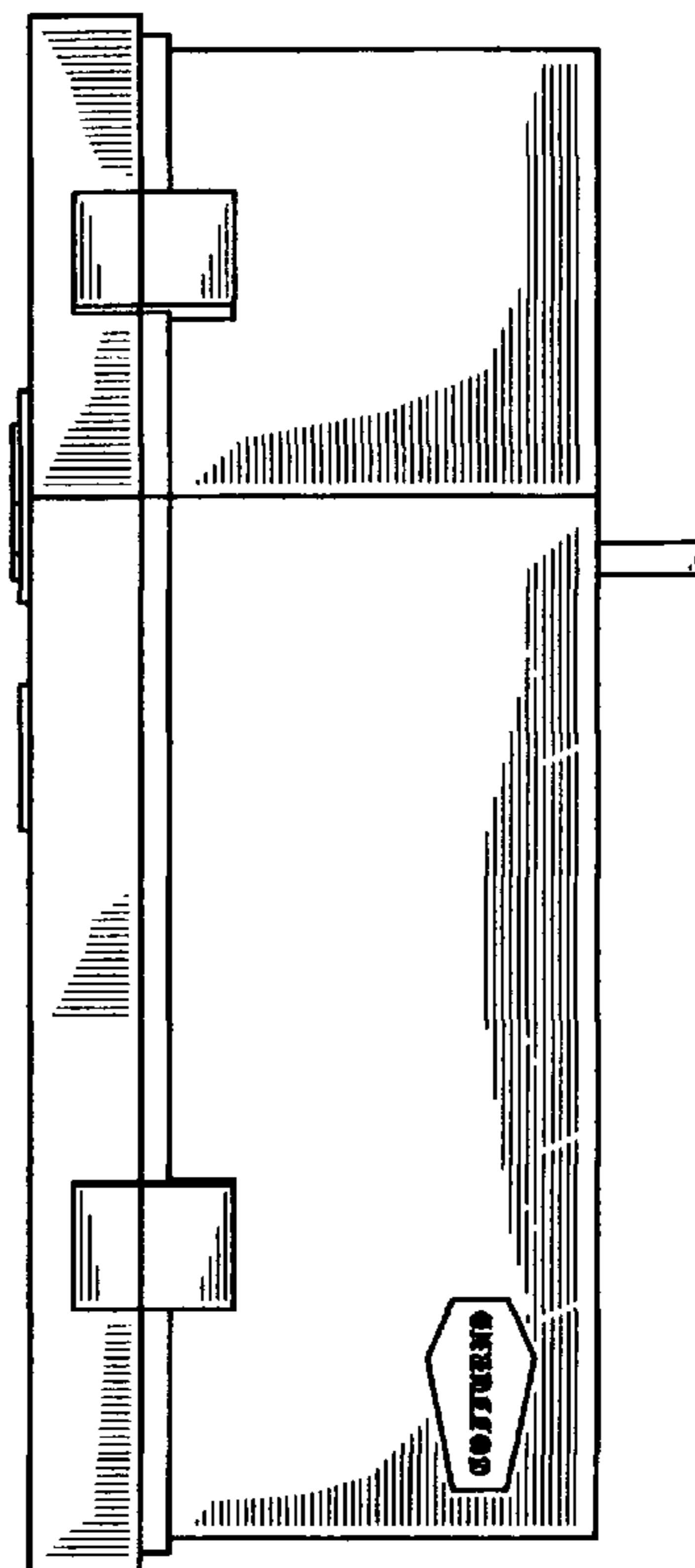
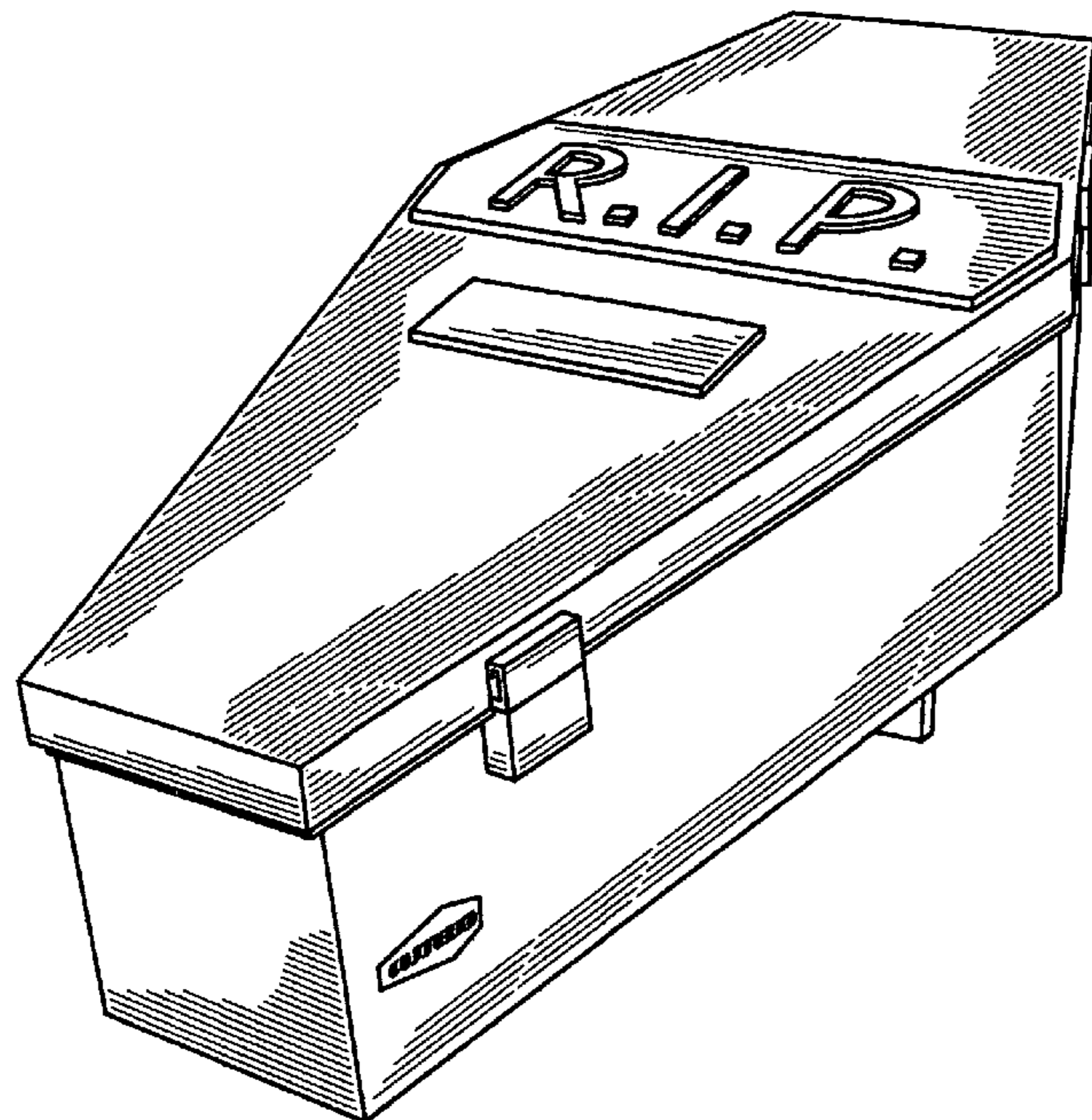

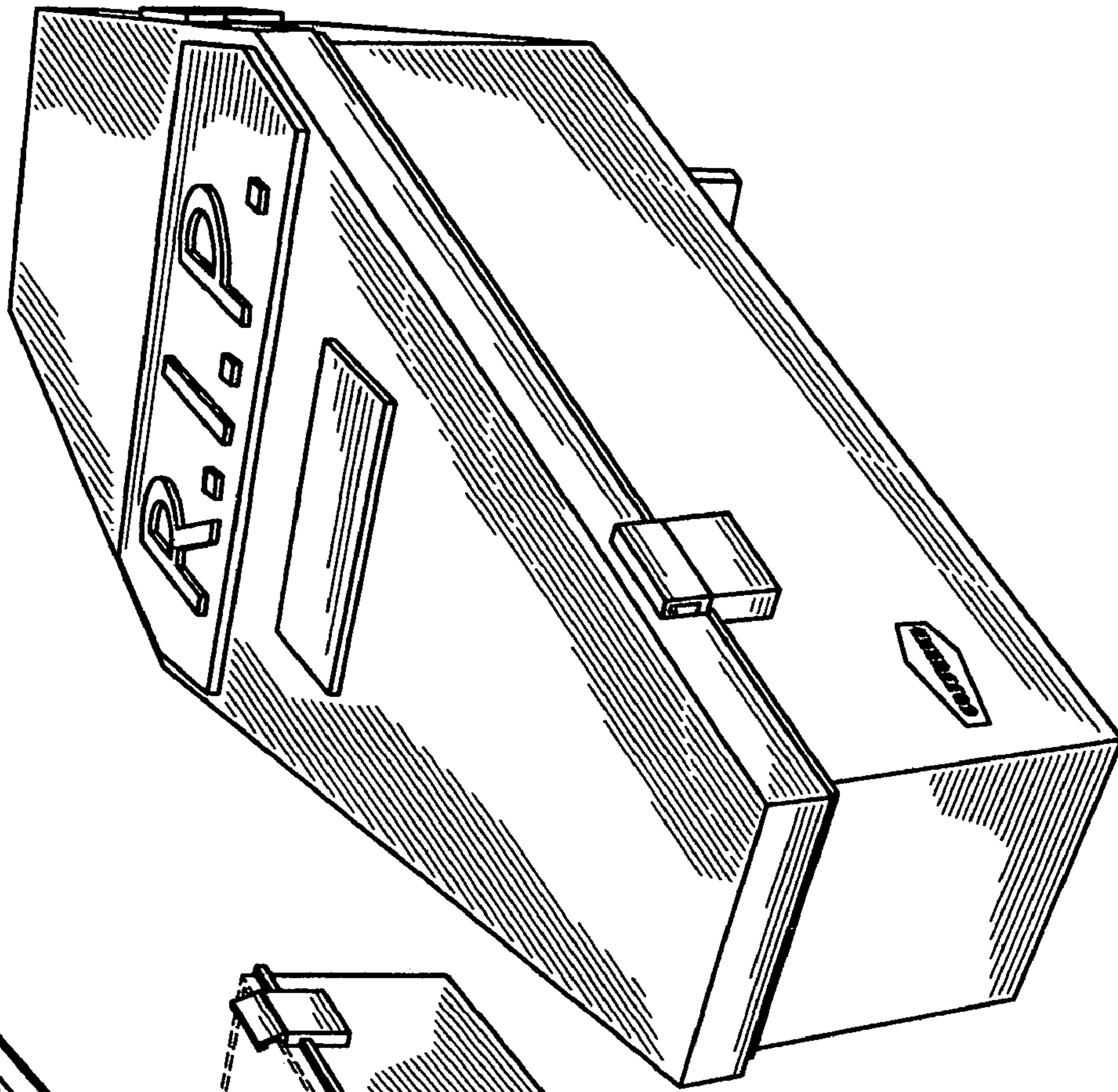

FIG. 1

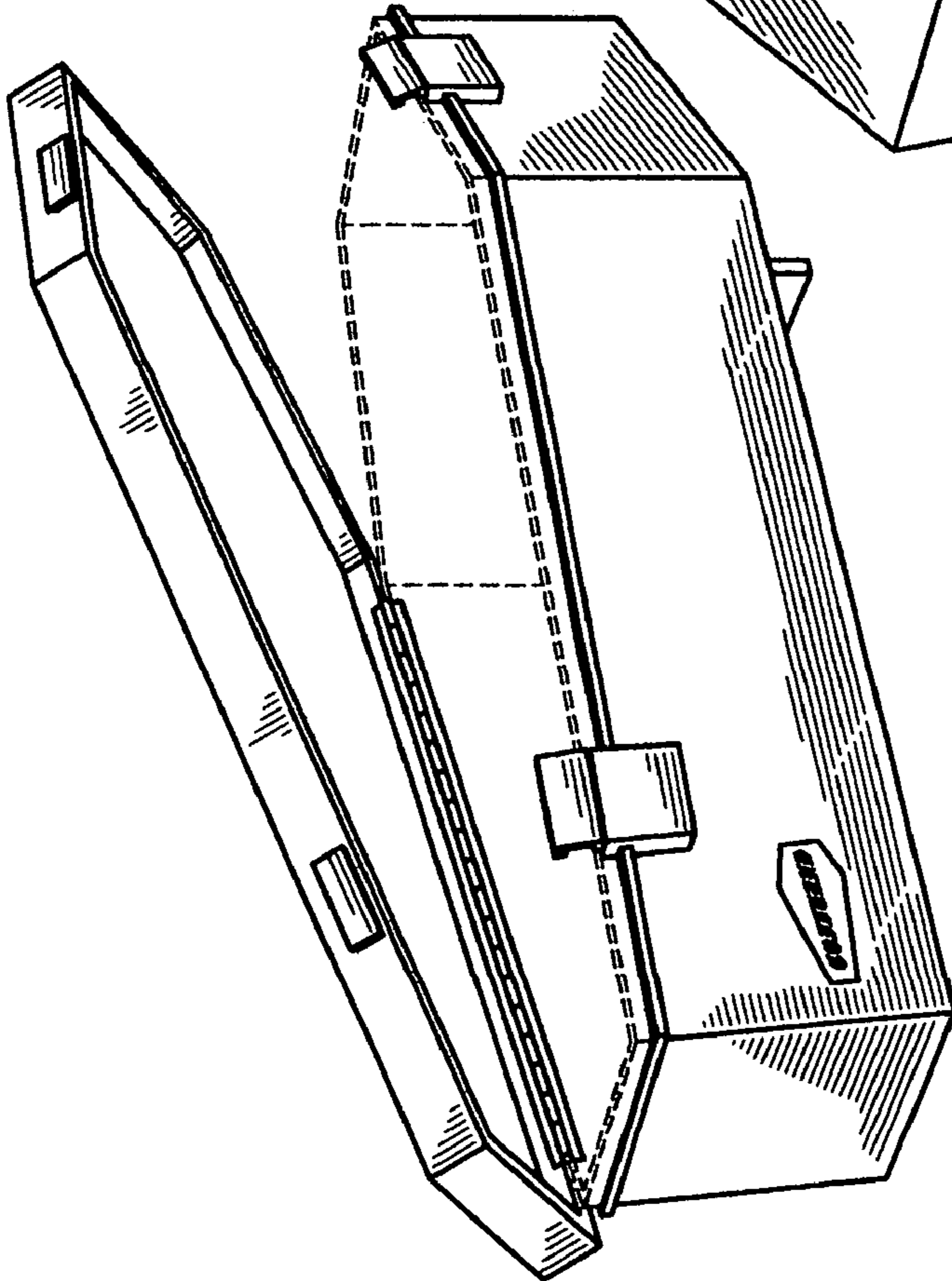

FIG. 2

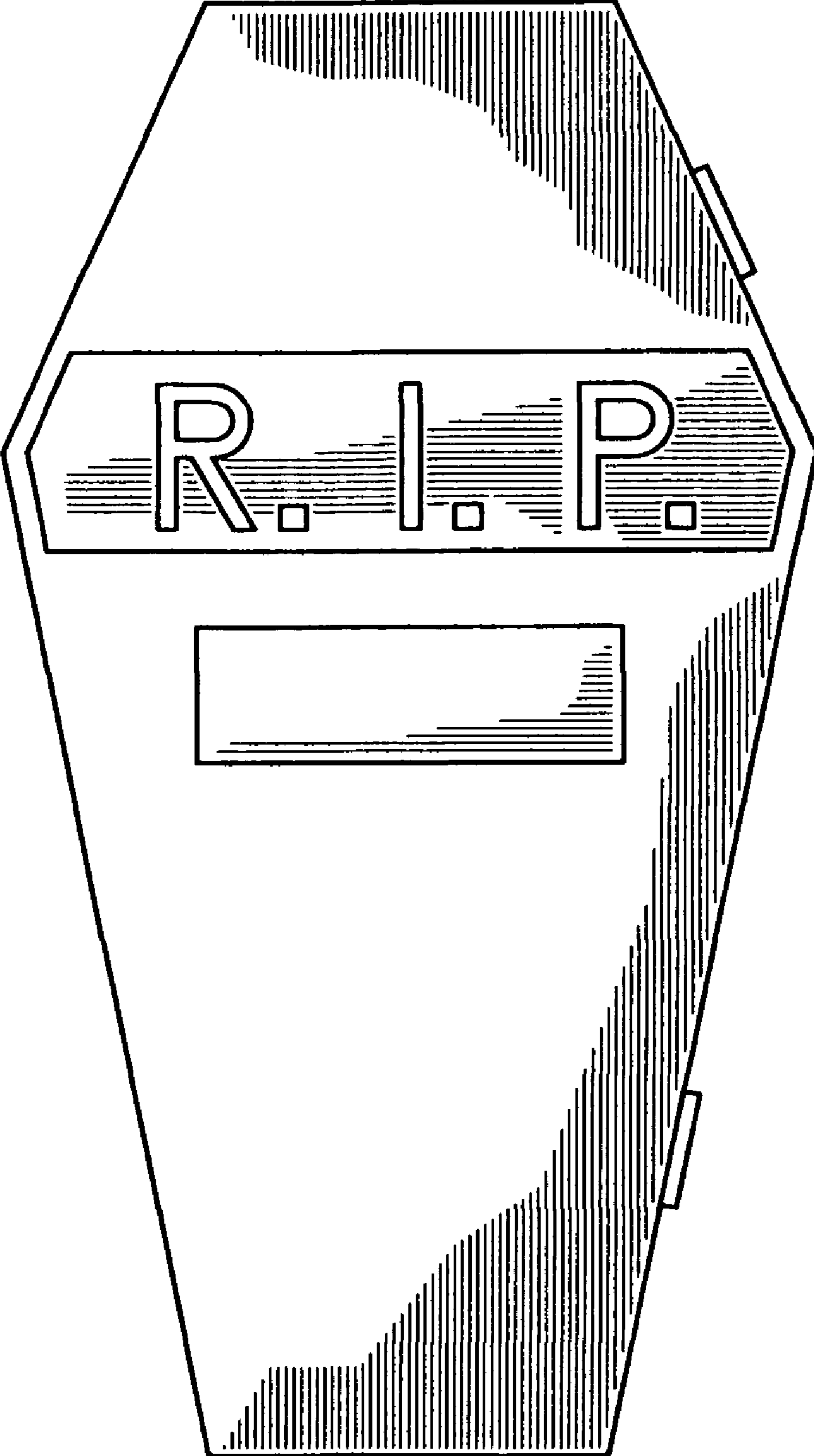

FIG. 3

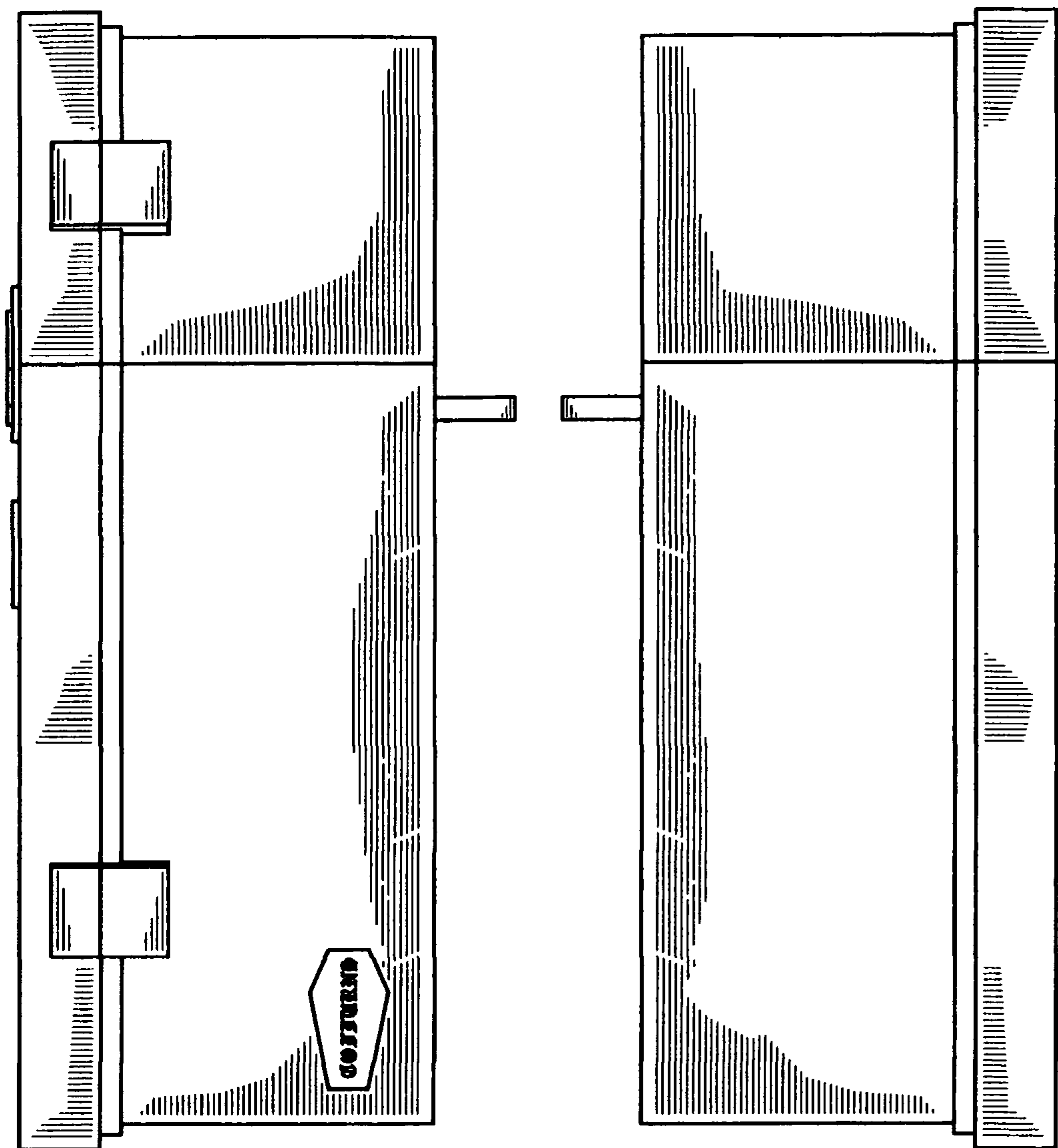

FIG. 4

FIG. 5

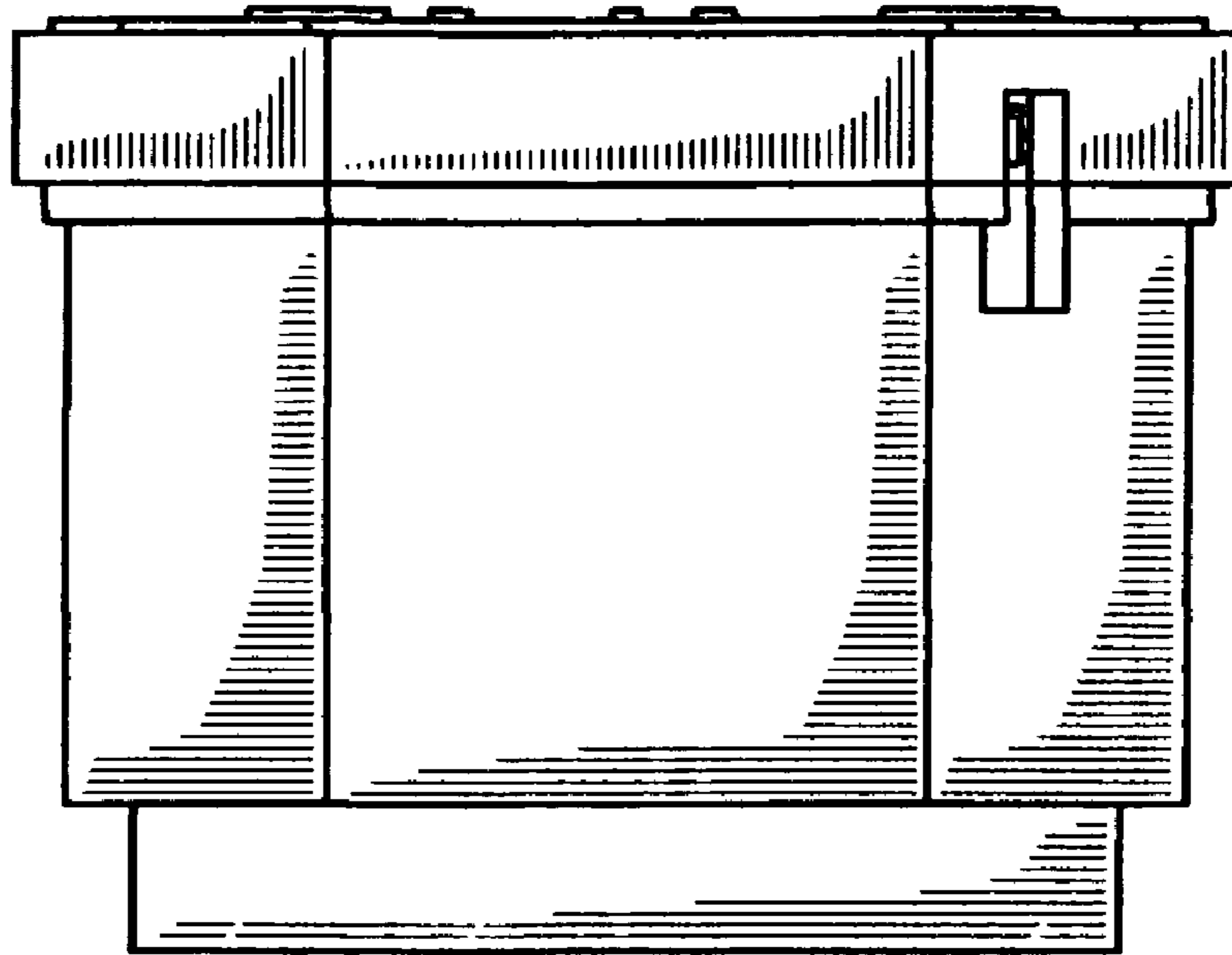

FIG. 6

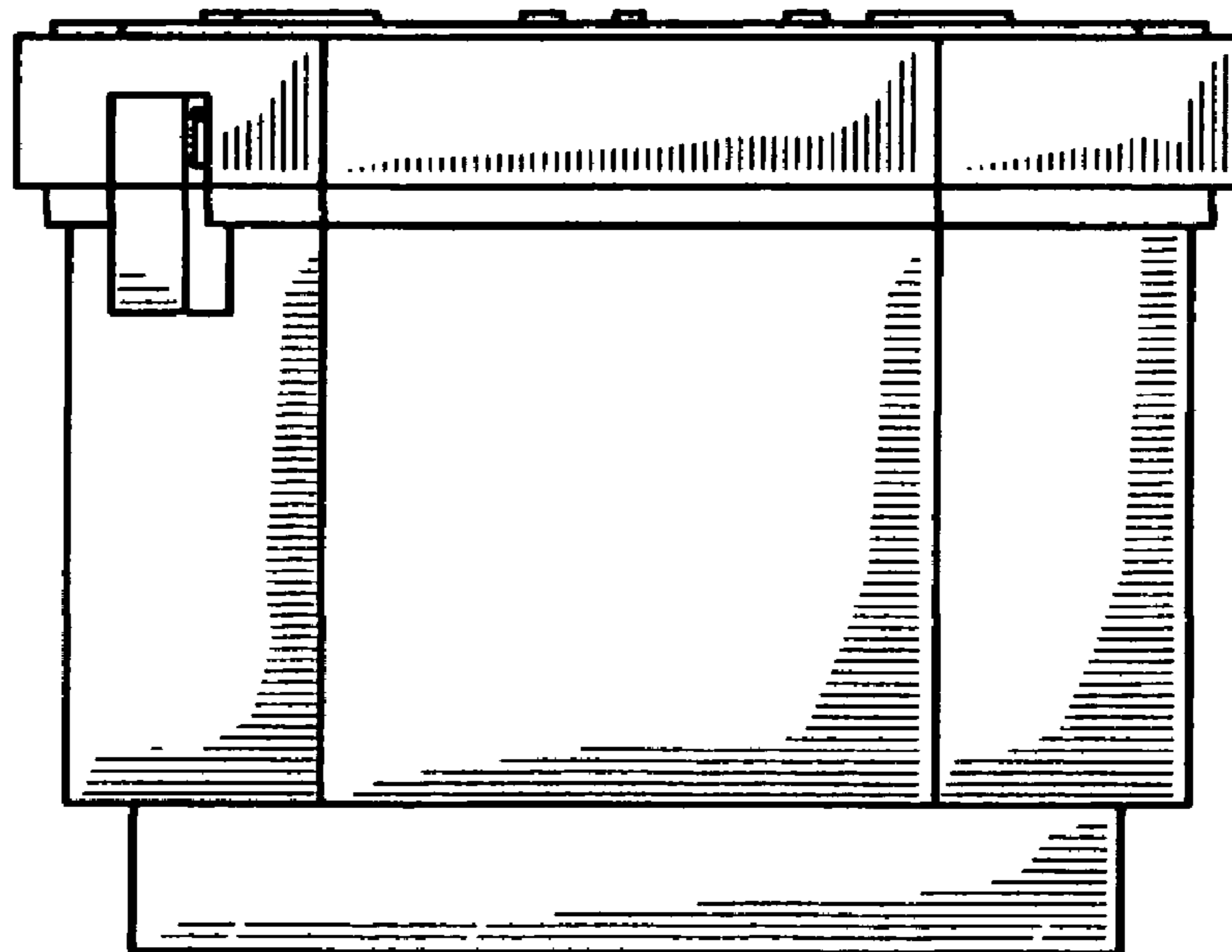

FIG. 7

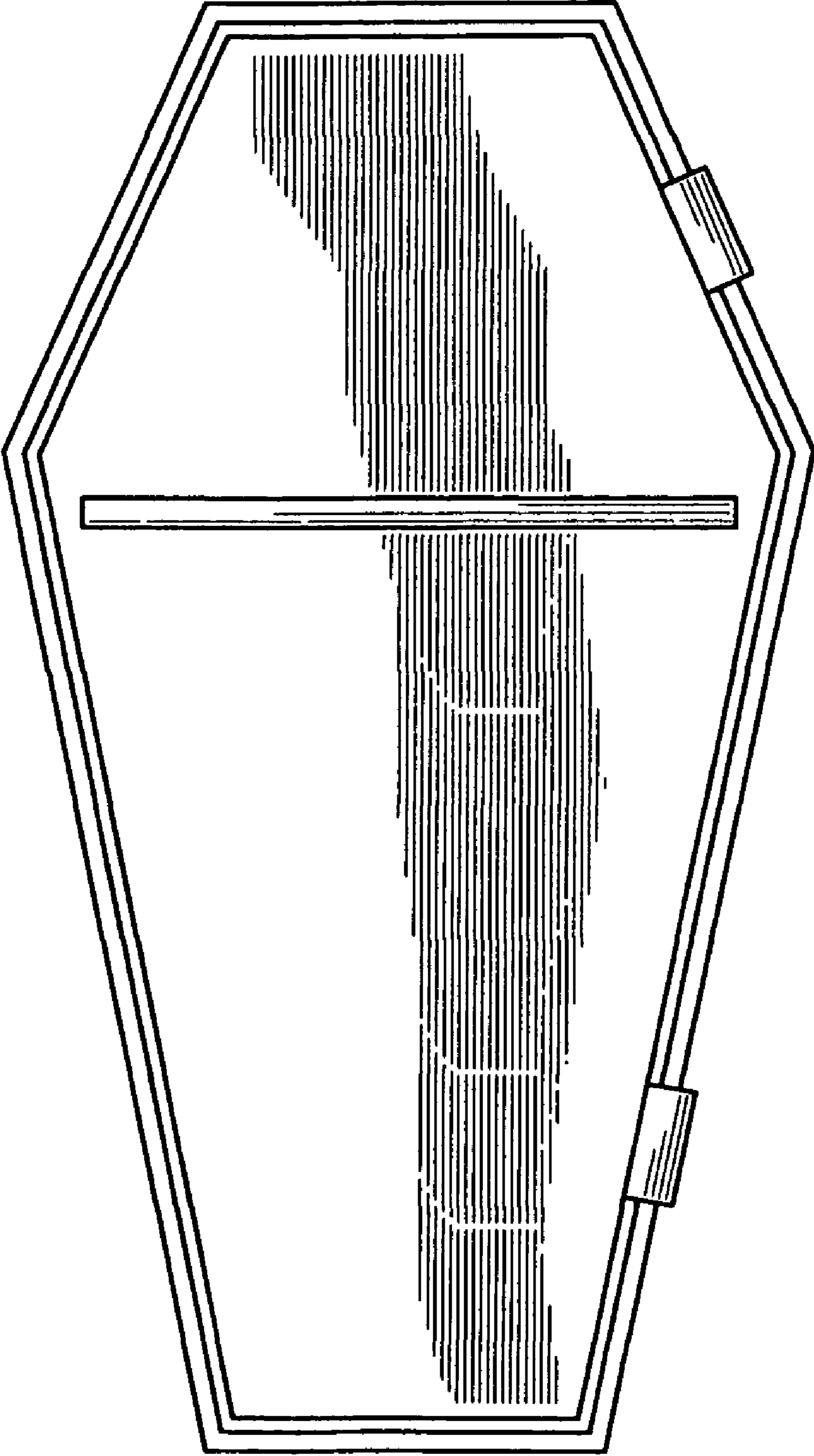

FIG. 8