



US00D659850S

(12) **United States Design Patent**
Thom

(10) **Patent No.:** **US D659,850 S**

(45) **Date of Patent:** **** May 15, 2012**

(54) **TEST TUBE RACK**

(75) Inventor: **Paul Thom**, Butler, NJ (US)

(73) Assignee: **Bel-Art Products**, Pequannock, NJ (US)

(**) Term: **14 Years**

(21) Appl. No.: **29/399,382**

(22) Filed: **Aug. 12, 2011**

(51) **LOC (9) Cl.** **24-02**

(52) **U.S. Cl.** **D24/229**

(58) **Field of Classification Search** D24/216,
D24/222, 224, 226, 227, 229, 230; 422/63-64,
422/99-104, 250, 266, 297, 330, 476, 561,
422/942, 553; 206/563, 446; 211/69, 71-72,
211/74, 71.01

See application file for complete search history.

(56) **References Cited**

U.S. PATENT DOCUMENTS

D246,466 S * 11/1977 Attree et al. D24/226
D257,390 S * 10/1980 Hahn et al. D24/230
D264,810 S * 6/1982 Voltmann D24/226

(Continued)

Primary Examiner — T. Chase Nelson

Assistant Examiner — Mark Cavanna

(74) *Attorney, Agent, or Firm* — Lowenstein Sandler PC

(57) **CLAIM**

The ornamental design for a test tube rack, as shown and described.

DESCRIPTION

FIG. 1 is a perspective view of a test tube rack showing my new design;

FIG. 2 is a perspective view of the top portion of the test tube rack seen in FIG. 1 shown separately for clarity of illustration;

FIG. 3 is a side view of FIG. 2;

FIG. 4 is a front or rear view of FIG. 2;

FIG. 5 is a top plan view of FIG. 2;

FIG. 6 is a bottom plan view of FIG. 2;

FIG. 7 is a perspective view of the center portion of the test tube rack seen in FIG. 1 shown separately for clarity of illustration;

FIG. 8 is a front or rear view of FIG. 7;

FIG. 9 is a side view of FIG. 7;

FIG. 10 is a top plan view of FIG. 7;

FIG. 11 is a bottom plan view of FIG. 7;

FIG. 12 is a perspective view of the bottom portion of the test tube rack seen in FIG. 1 shown separately for clarity of illustration;

FIG. 13 is a side view of FIG. 12;

FIG. 14 is a front or rear view of FIG. 12;

FIG. 15 is a top plan view of FIG. 12;

FIG. 16 is a bottom plan view of FIG. 12;

FIG. 17 is a perspective view of the detachable portion of the top and center portions of the test tube rack seen in FIG. 1 shown separately for clarity of illustration;

FIG. 18 is a front or rear view of FIG. 17;

FIG. 19 is a right side view of FIG. 17;

FIG. 20 is a left side view of FIG. 17;

FIG. 21 is a top plan view of FIG. 17; and,

FIG. 22 is a bottom plan view of FIG. 17.

The broken lines are included for the purpose of illustrating portions of the test tube rack system that forms no part of the claimed design.

1 Claim, 11 Drawing Sheets

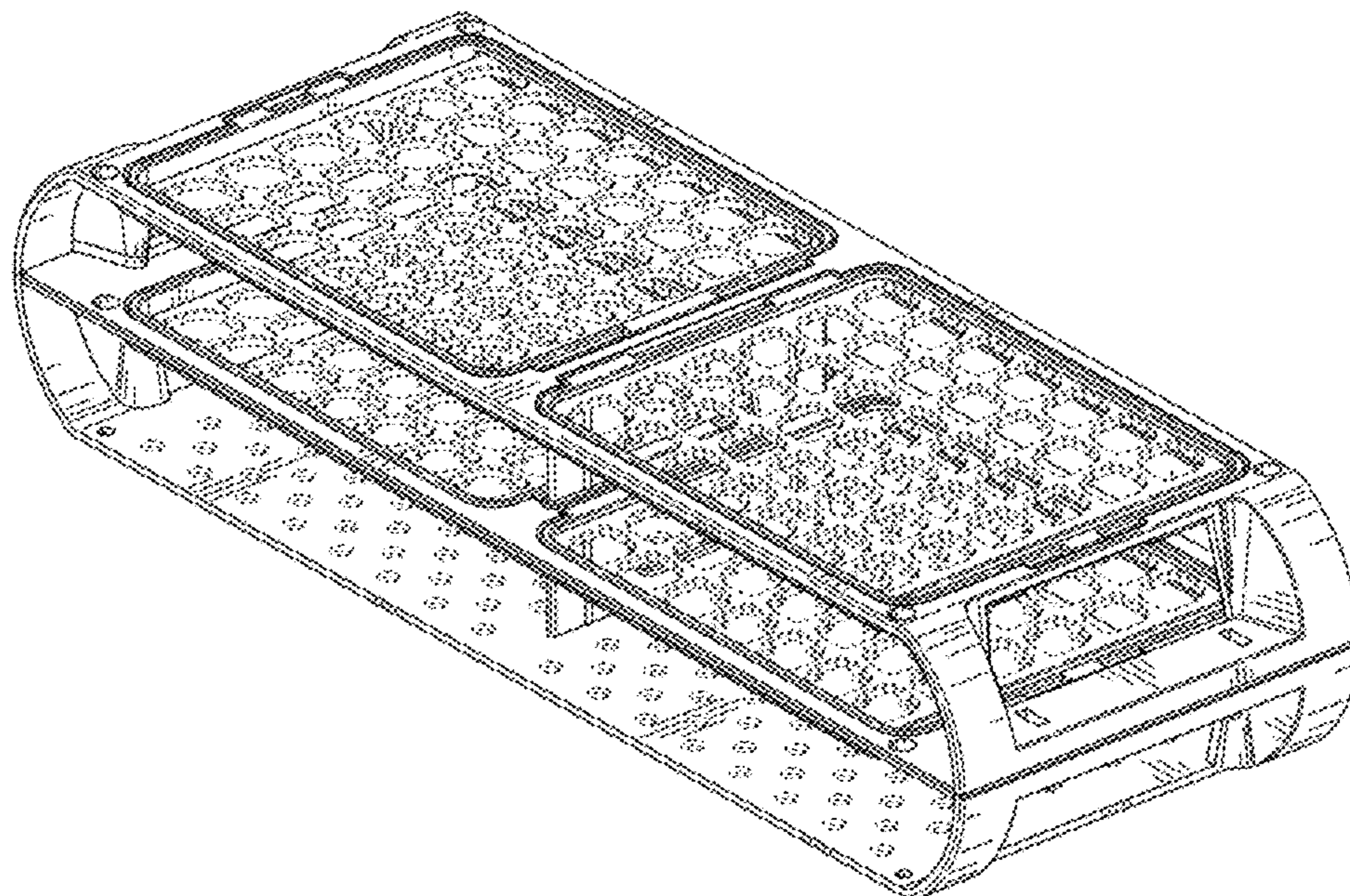

US D659,850 S

Page 2

U.S. PATENT DOCUMENTS

| | | | | | | |
|-----------|---|---|---------|-------------------|-------|---------|
| D265,126 | S | * | 6/1982 | Beall | | D24/230 |
| D282,579 | S | * | 2/1986 | Juergens | | D24/230 |
| D283,162 | S | * | 3/1986 | Godsey | | D24/226 |
| D284,700 | S | * | 7/1986 | Mehra et al. | | D24/229 |
| D302,207 | S | * | 7/1989 | Matkovich | | D24/226 |
| 5,048,957 | A | * | 9/1991 | Berthold et al. | | 422/942 |
| 5,487,872 | A | * | 1/1996 | Hafeman et al. | | 422/553 |
| D392,743 | S | * | 3/1998 | Stoufer | | D24/230 |
| D413,391 | S | * | 8/1999 | Lapeus et al. | | D24/229 |
| D413,677 | S | * | 9/1999 | Dumitrescu et al. | | D24/227 |
| D414,271 | S | * | 9/1999 | Mendoza | | D24/227 |
| D417,009 | S | * | 11/1999 | Boyd | | D24/229 |
| D420,142 | S | * | 2/2000 | Ballin et al. | | D24/230 |
| D420,743 | S | * | 2/2000 | Monks | | D24/226 |
| D420,747 | S | * | 2/2000 | Dumitrescu et al. | | D24/227 |
| D421,130 | S | * | 2/2000 | Cohen et al. | | D24/229 |
| D428,497 | S | * | 7/2000 | Lapeus et al. | | D24/227 |
| D448,854 | S | * | 10/2001 | Kuiper et al. | | D24/230 |
| D461,554 | S | * | 8/2002 | Lafond et al. | | D24/230 |
| D466,219 | S | * | 11/2002 | Wynschenk et al. | | D24/227 |
| D469,544 | S | * | 1/2003 | Lafond et al. | | D24/226 |
| D529,622 | S | * | 10/2006 | Hadjis et al. | | D24/229 |
| D533,948 | S | * | 12/2006 | Schaub et al. | | D24/229 |
| D556,338 | S | * | 11/2007 | Coulling et al. | | D24/230 |
| D556,339 | S | * | 11/2007 | Coulling et al. | | D24/230 |
| D596,312 | S | * | 7/2009 | Giraud et al. | | D24/230 |
| D622,860 | S | * | 8/2010 | Karpiloff | | D24/230 |
| D632,404 | S | * | 2/2011 | Karpiloff | | D24/230 |
| D638,138 | S | * | 5/2011 | Wong | | D24/227 |
| D639,447 | S | * | 6/2011 | Karpiloff | | D24/230 |

* cited by examiner

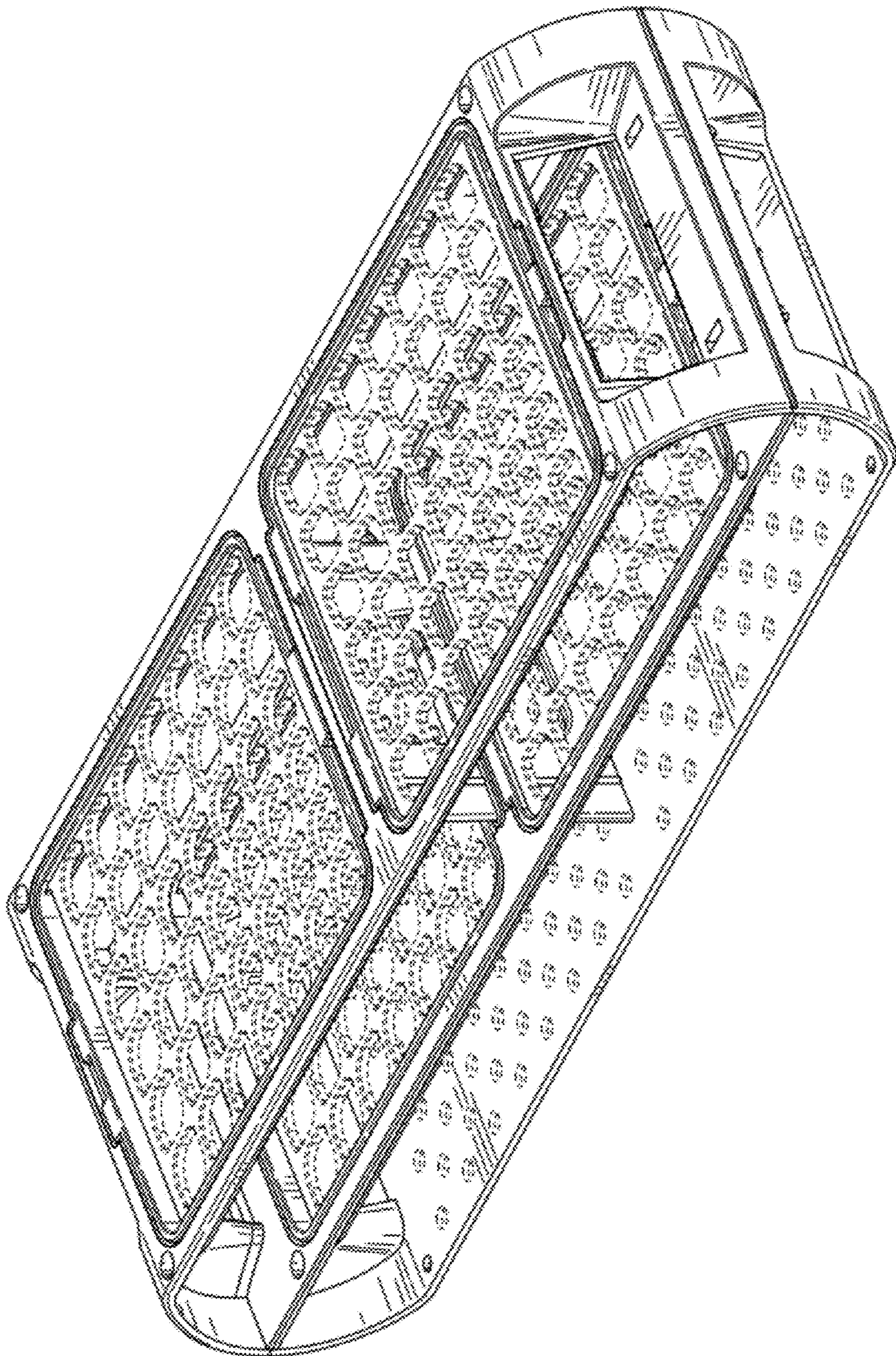

FIG. 1

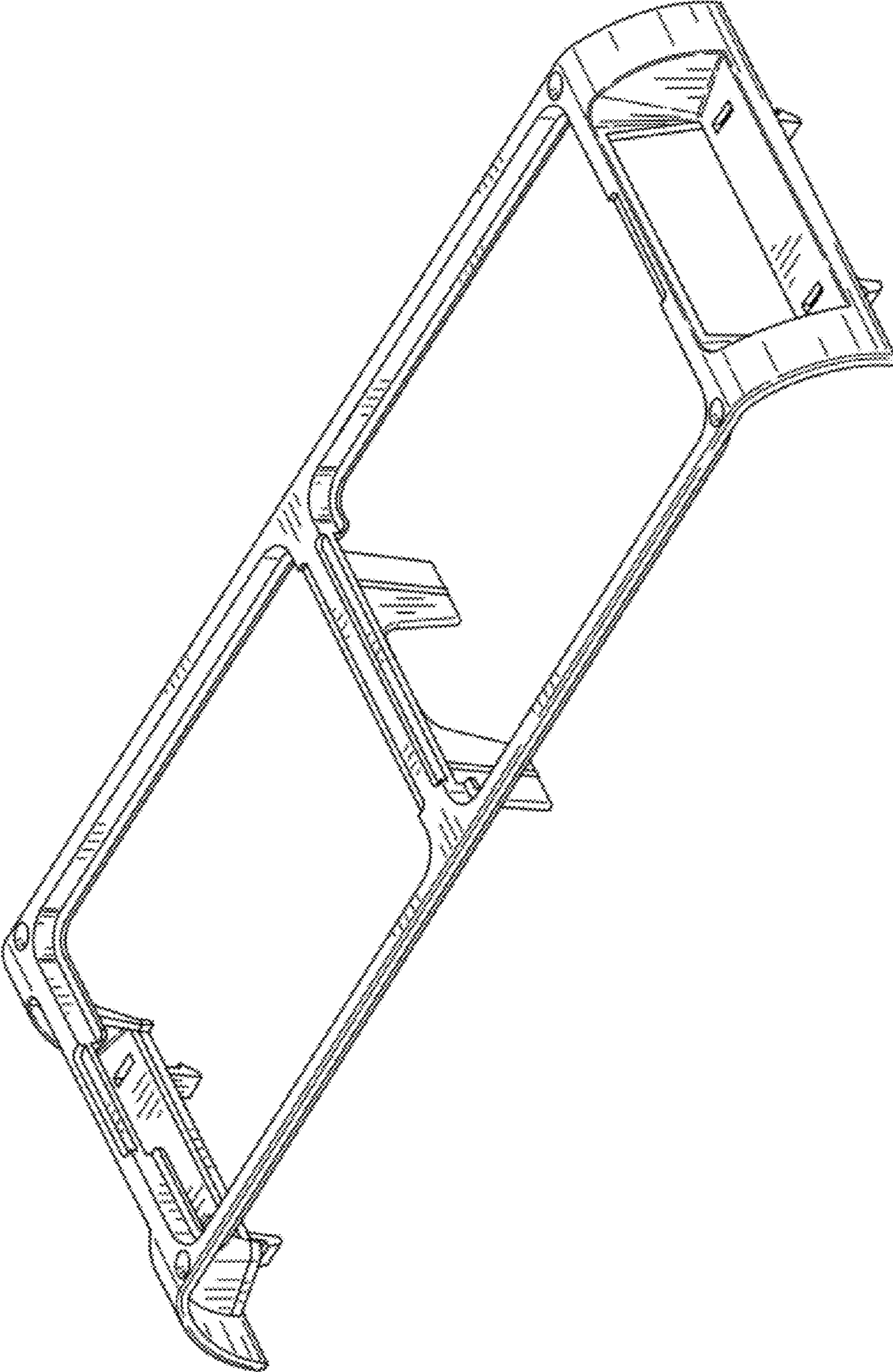

FIG. 2

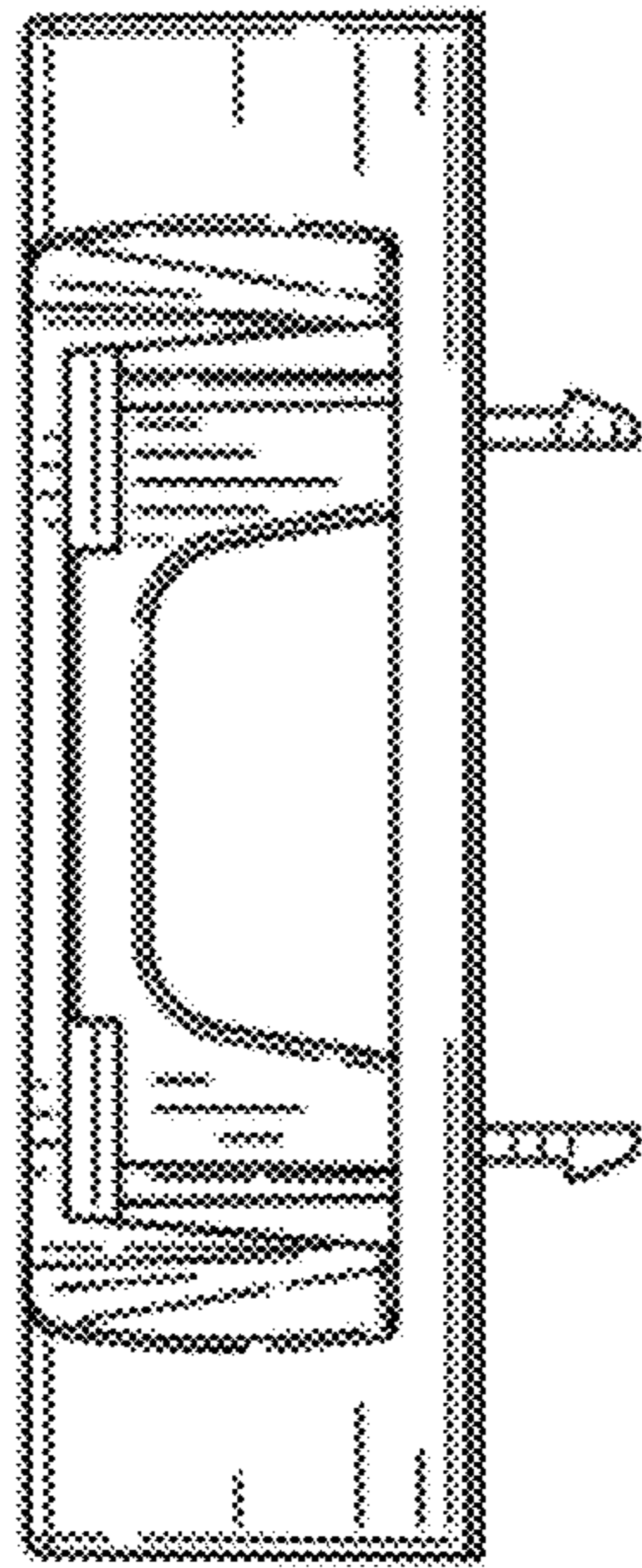

FIG. 3

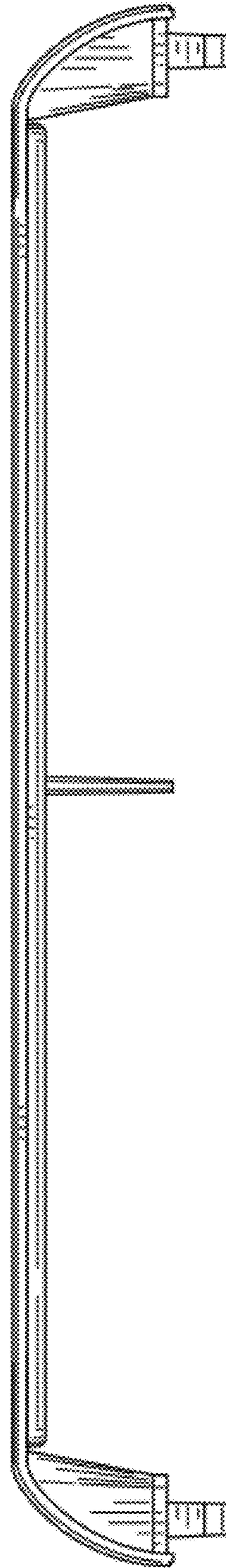

FIG. 4

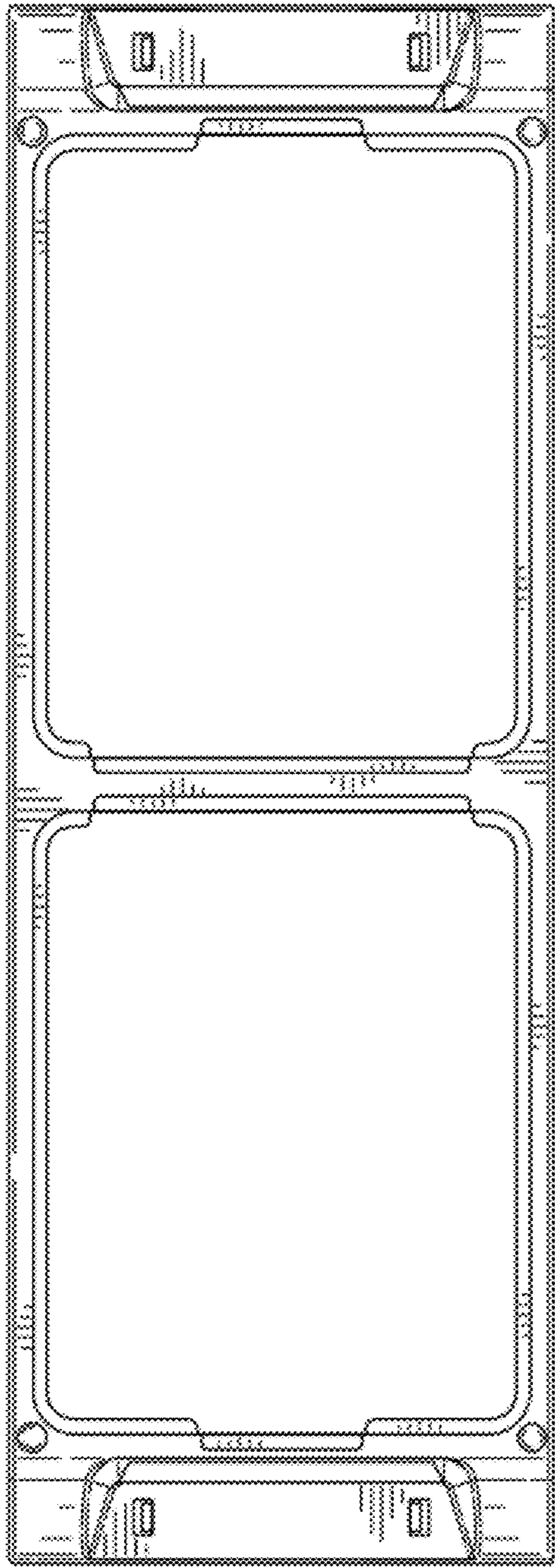

FIG. 5

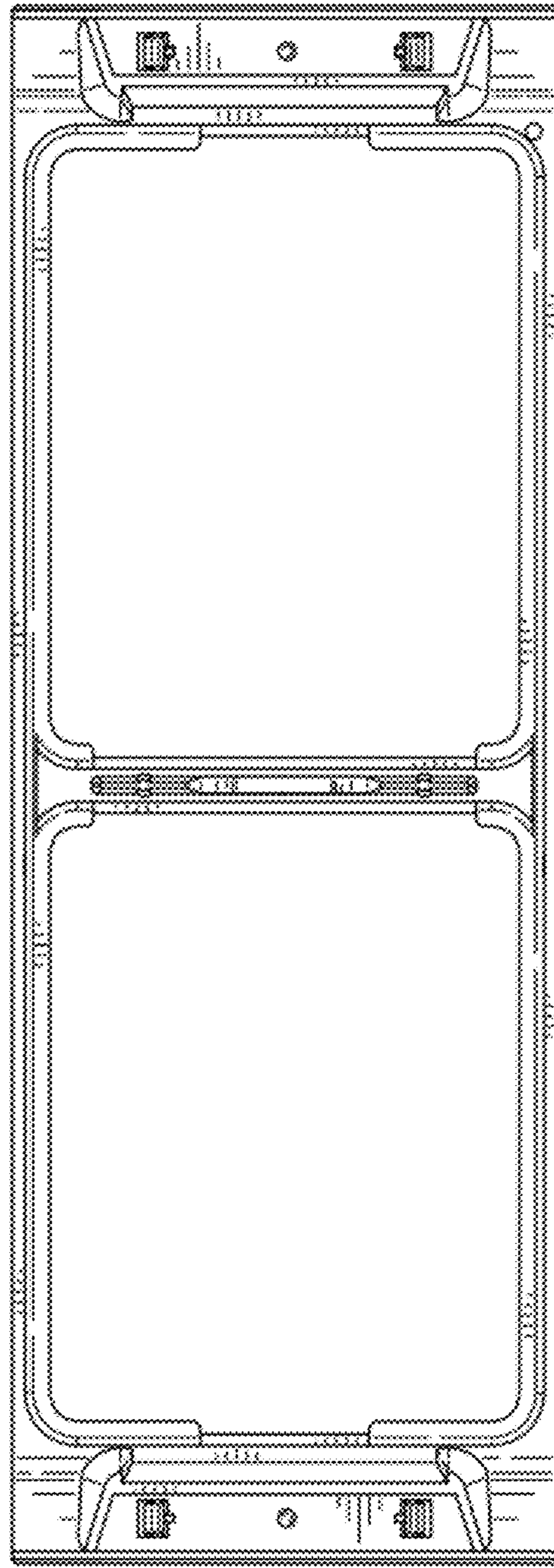

FIG. 6

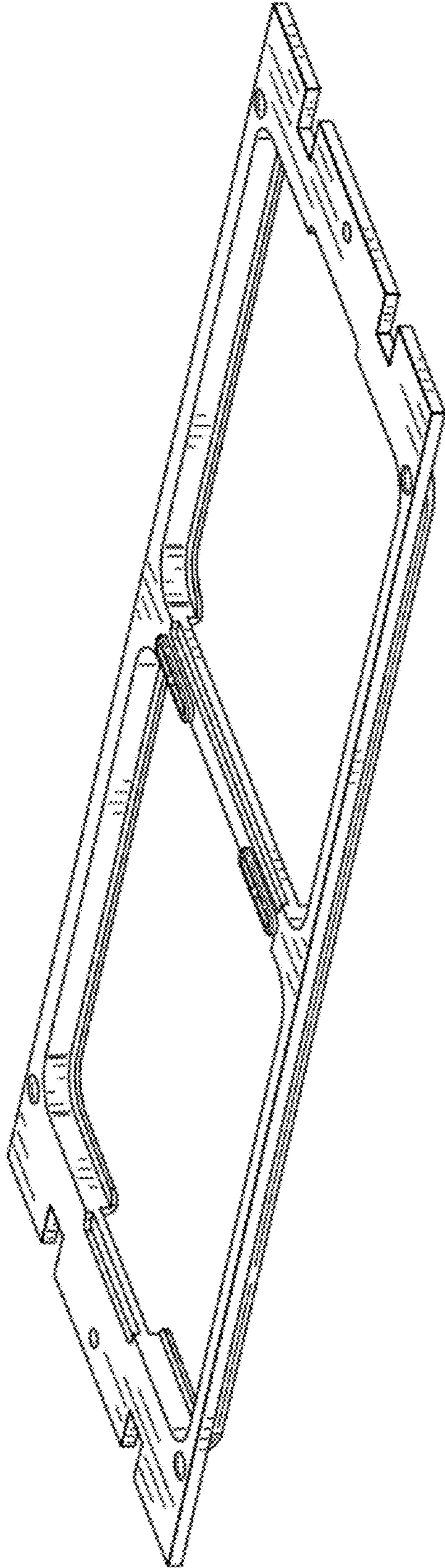

FIG. 7



FIG. 8

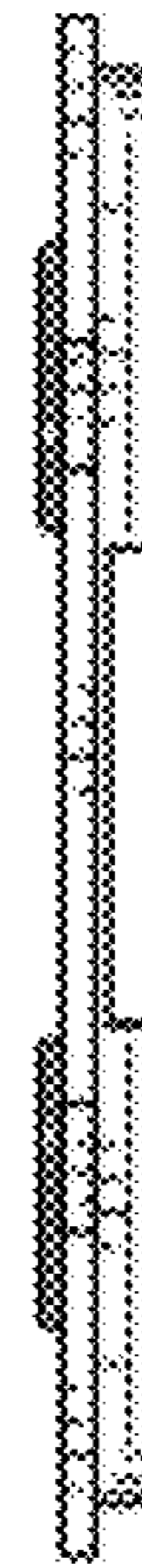

FIG. 9

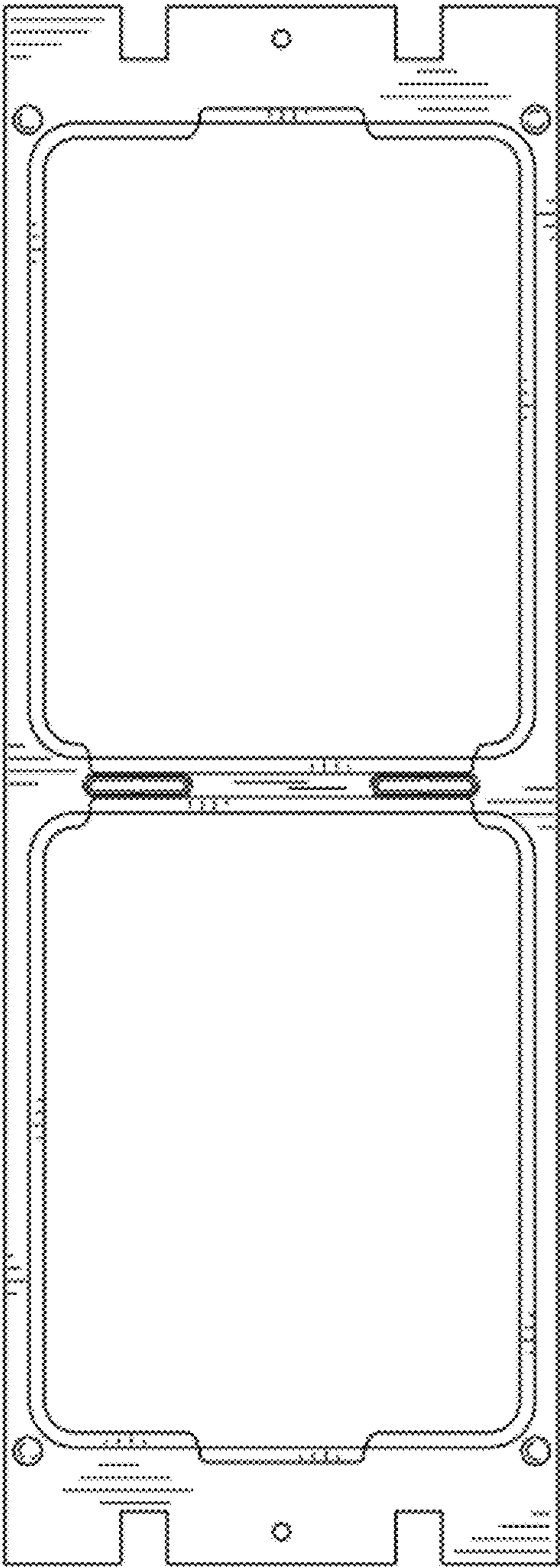

FIG. 10

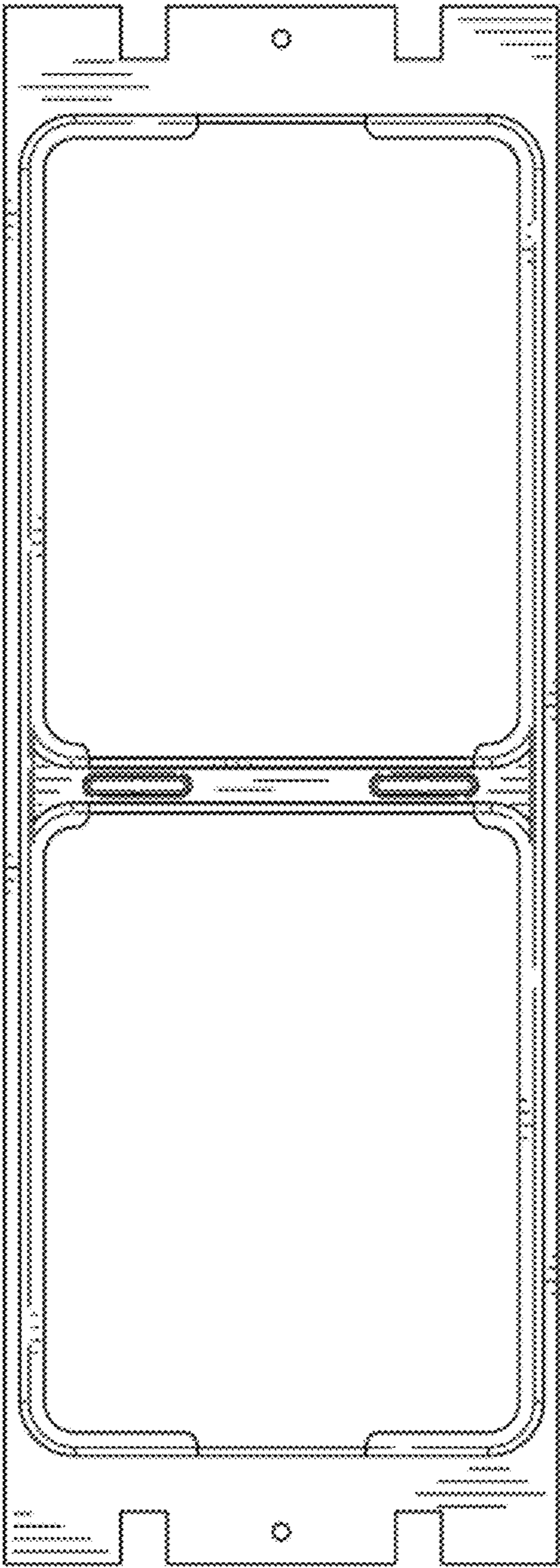

FIG. 11

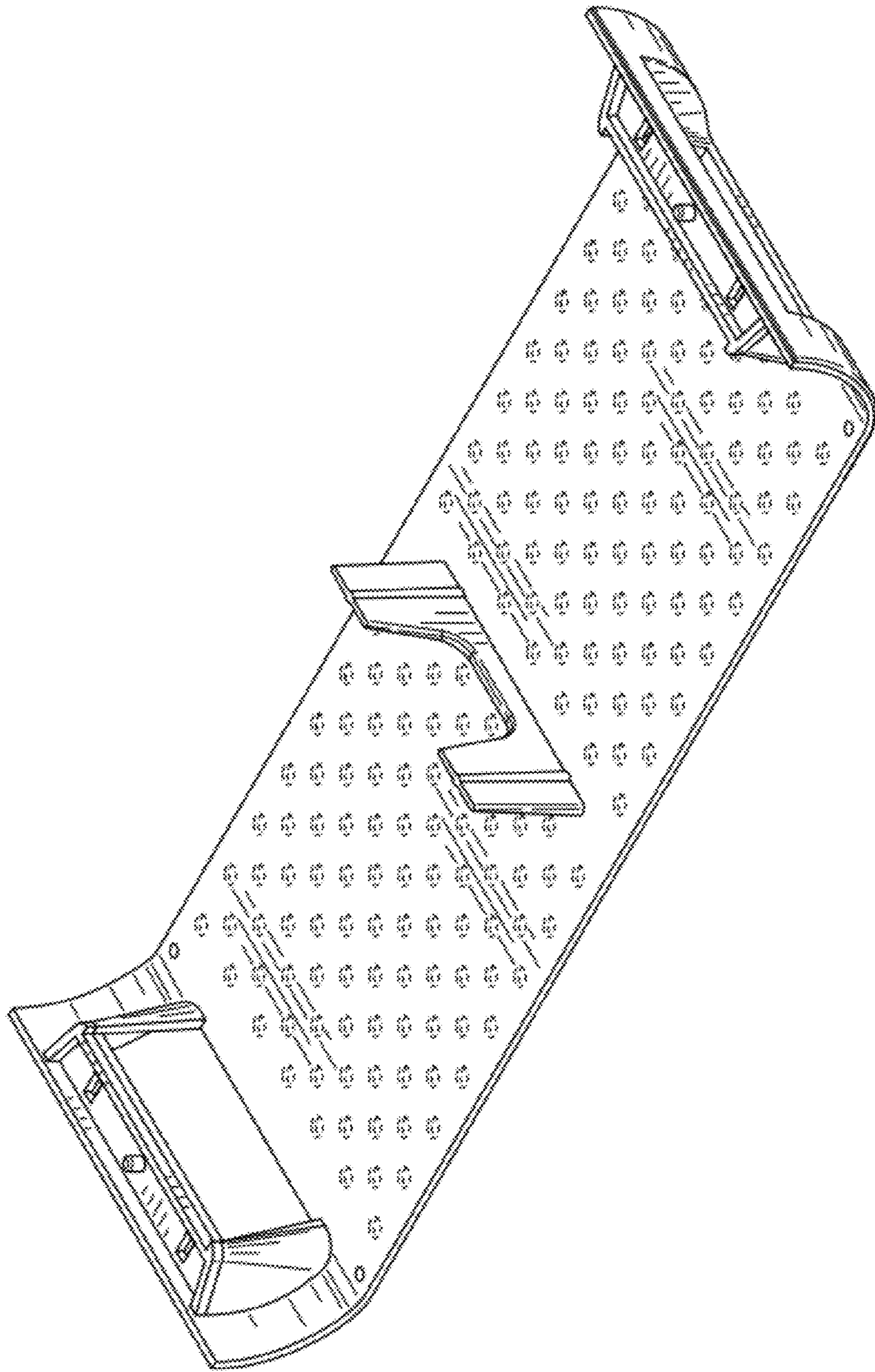

FIG. 12

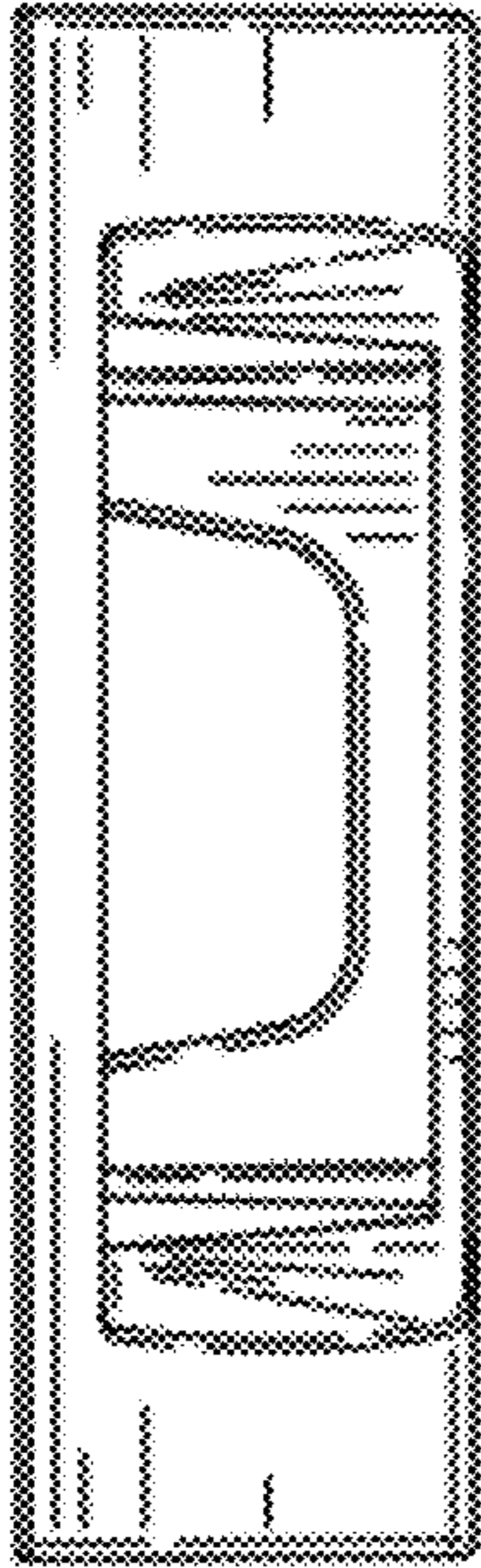

FIG. 13

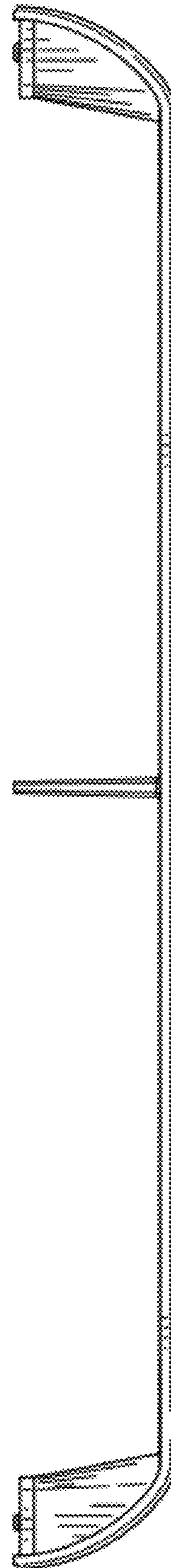

FIG. 14

FIG. 15

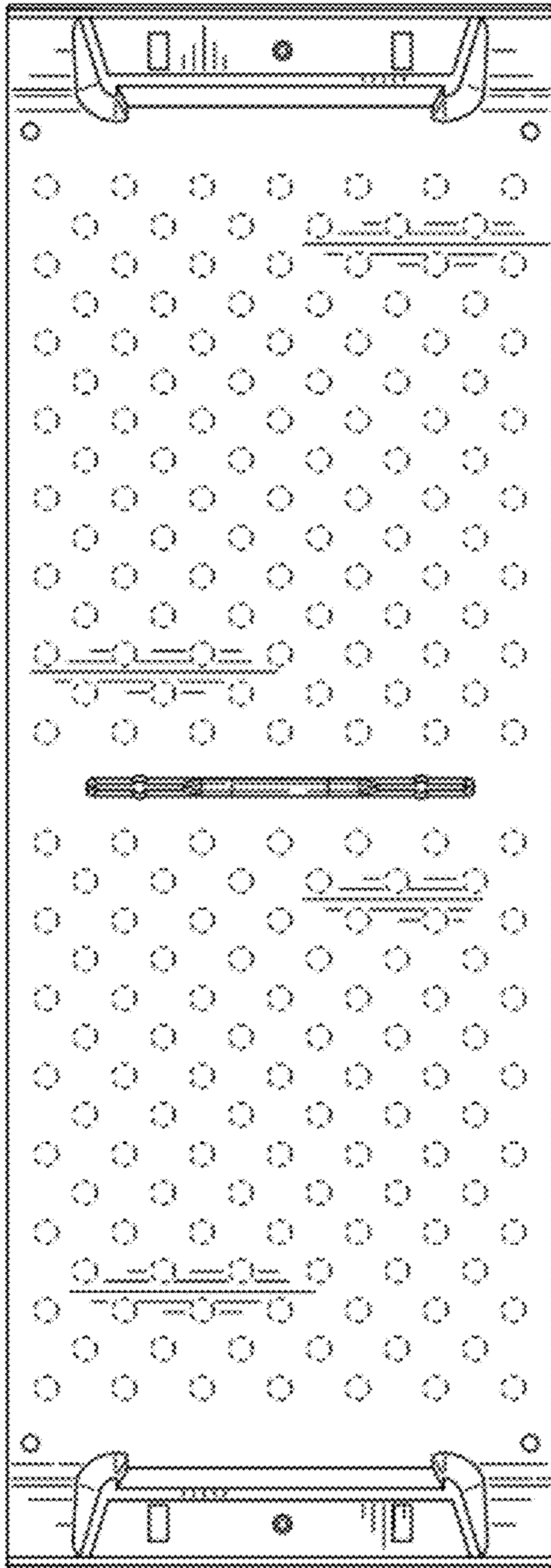
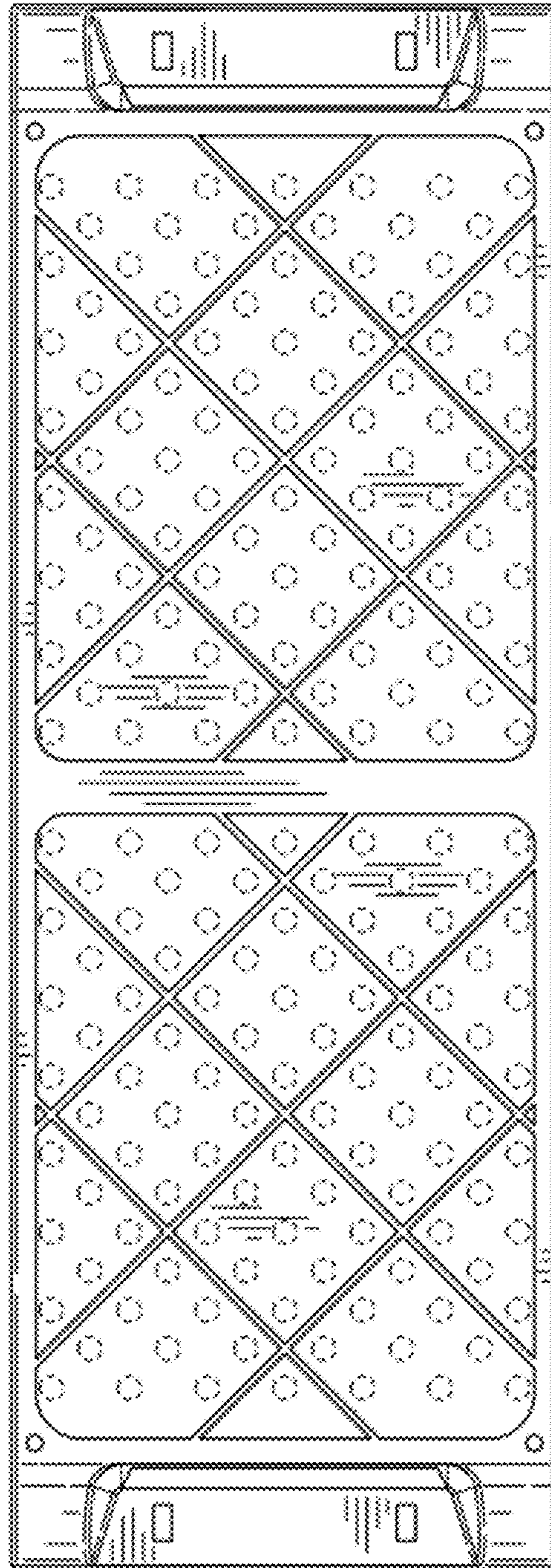

FIG. 16



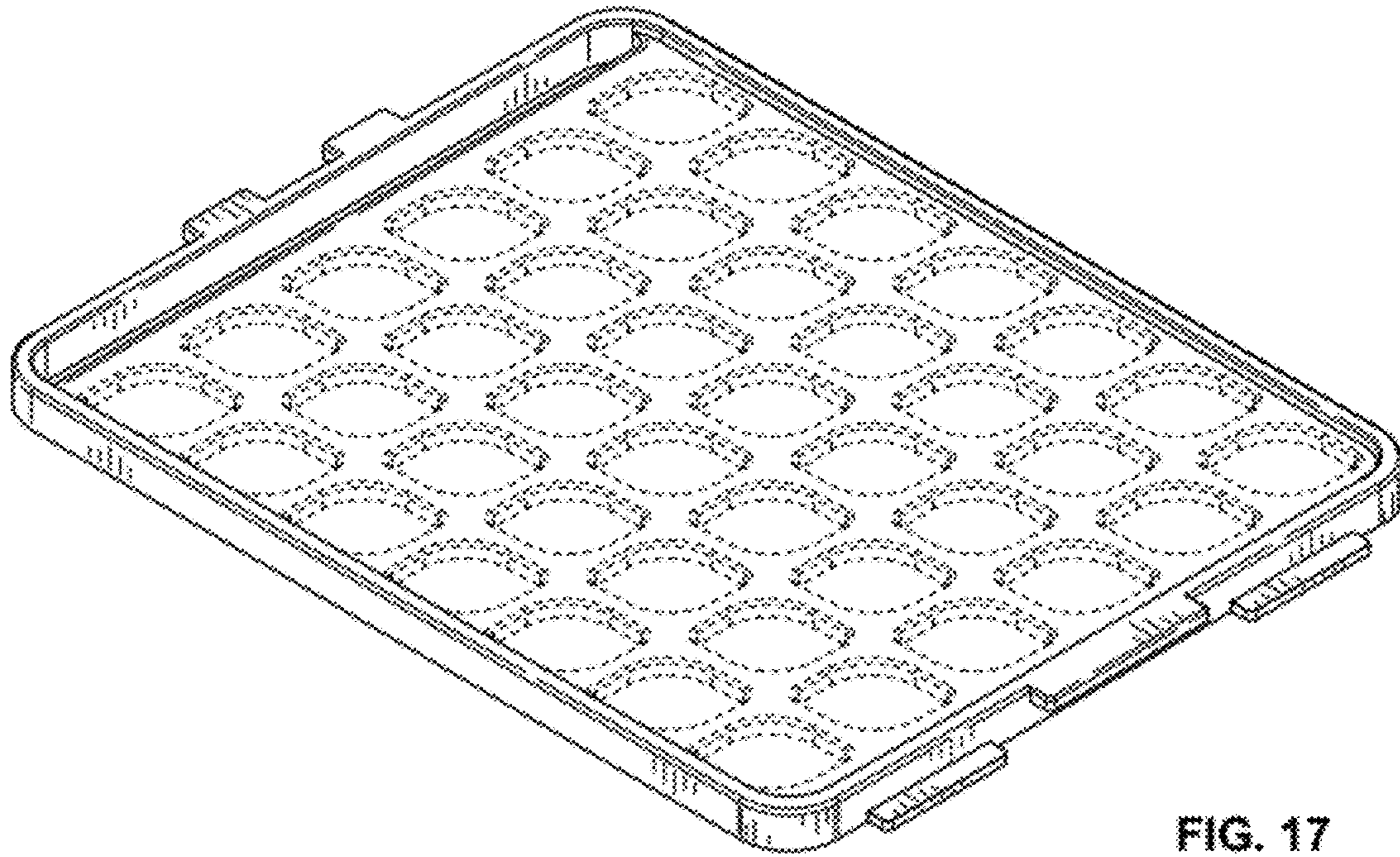

FIG. 17



FIG. 18

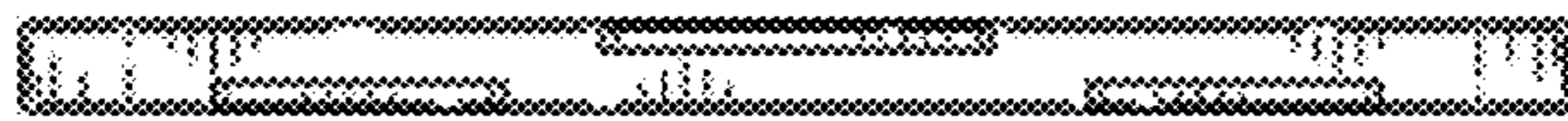

FIG. 19



FIG. 20

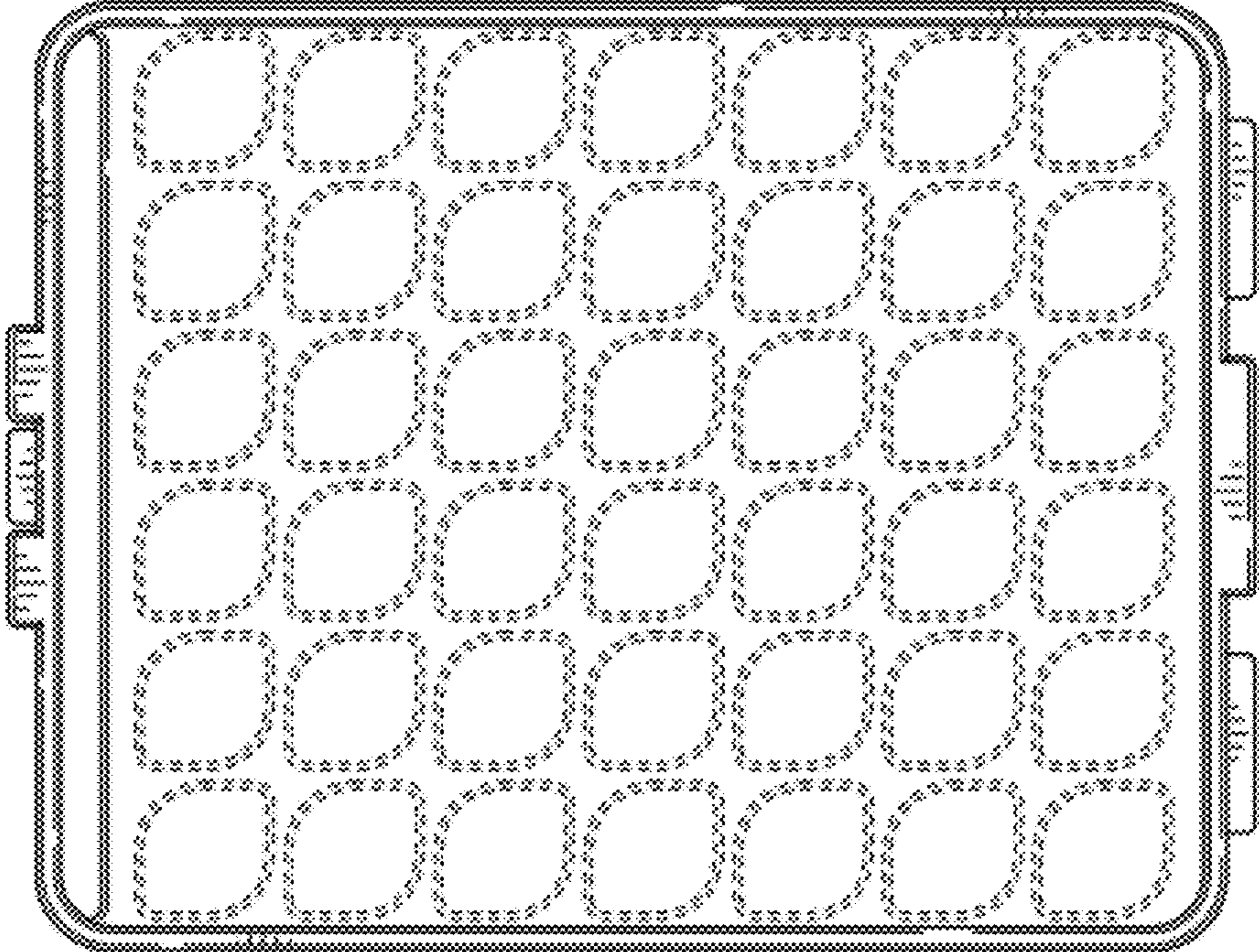

FIG. 21

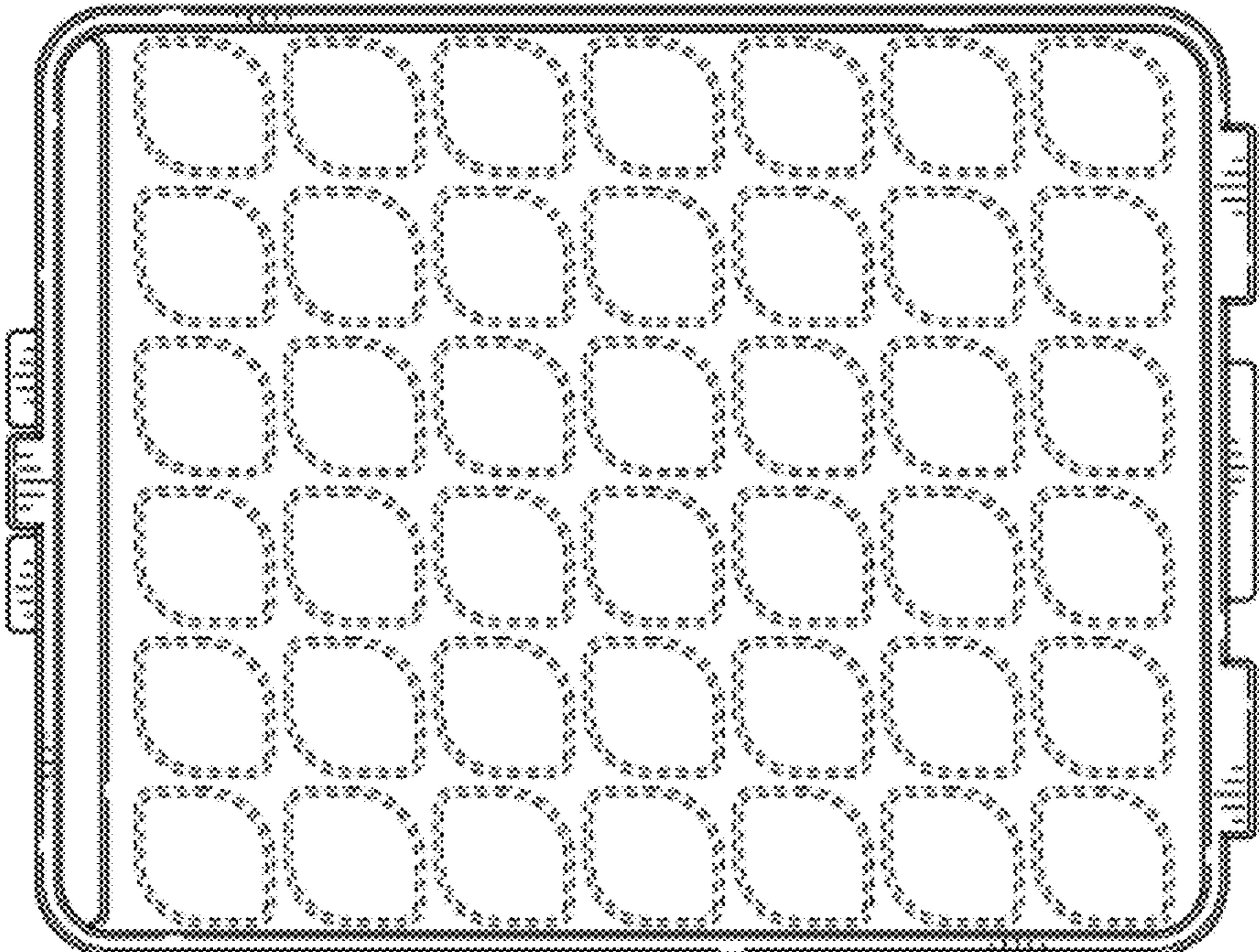

FIG. 22