



US00D659537S

(12) **United States Design Patent**
Ritzenhoff

(10) **Patent No.:** **US D659,537 S**

(45) **Date of Patent:** **** May 15, 2012**

(54) **CONTAINER FOR FRAGRANT ESSENCE**

(75) Inventor: **Andreas Ritzenhoff**, Marburg (DE)

(73) Assignee: **Seidel GmbH & Co. KG**, Marburg (DE)

(**) Term: **14 Years**

(21) Appl. No.: **29/368,490**

(22) Filed: **Aug. 24, 2010**

(30) **Foreign Application Priority Data**

Feb. 25, 2010 (DE) 001674334-0004/0005

(51) **LOC (9) Cl.** **09-01**

(52) **U.S. Cl.** **D9/500; D23/366**

(58) **Field of Classification Search** D9/500,
D9/502-505, 516, 545, 549, 554, 557-558,
D9/574-575, 682, 686, 688-692; D7/300,
D7/598; D23/366; 215/379, 382-384; 220/660,
220/662, 669, 675

See application file for complete search history.

(56) **References Cited**

U.S. PATENT DOCUMENTS

D47,278 S	4/1915	Weicker	
D80,015 S	12/1929	Boever	
D87,655 S	8/1932	Wolcott	
D163,390 S	5/1951	Hofmann	
D207,882 S *	6/1967	Coulthurst	D9/522
D291,179 S	8/1987	Frizon	
D291,523 S *	8/1987	Minuti	D7/300.1
D367,009 S	2/1996	Dinand	
D449,532 S	10/2001	Modjeski	
D451,806 S	12/2001	Stalder	
D459,656 S *	7/2002	Burger	D9/503
D461,419 S *	8/2002	Burger	D9/545
D464,571 S	10/2002	Hill et al.	
D497,795 S	11/2004	Fling et al.	
D545,135 S *	6/2007	Bodum	D7/598
D545,136 S *	6/2007	Bodum	D7/598
D576,880 S	9/2008	Couey	

D580,267 S *	11/2008	DeMarco	D9/503
D598,286 S *	8/2009	DeMarco	D9/500
D627,650 S	11/2010	Yeung	

OTHER PUBLICATIONS

“Tribute Cologne for Men”, “Tribute After Shave Lotion” and Tribute Electric Pre-Shave Lotion, Avon Products & California Perfume Co. Collector’s Encyclopedia, 15th Edition, by Bud Hastin, Pub. By Bob Hastin, Florida, © 1998, pp. 178-179.*

“Cacharel Cologne by Cacharel”, FragranceNet.com, retrieved Dec. 2010, <http://www.fragrancenet.com/cacharel-cologne/cacharel/mens-fragrances/mf/en_US/00392?cur_letter=C>.*

“Grace”, ABA Packaging Corporation Catalog, ABA Packaging Corp., Holtsville, NY, 2004, middle of p. 14.*

Notice of Allowance issued in co-pending related U.S. Appl. No. 29/368,491 on Dec. 22, 2011.

* cited by examiner

Primary Examiner — Ian Simmons

Assistant Examiner — Dana L Sipos

(74) *Attorney, Agent, or Firm* — Griffin & Szipl, P.C.

(57) **CLAIM**

The ornamental design for a container for fragrant essence, as shown and described.

DESCRIPTION

FIG. 1 is a top perspective view of a container for fragrant essence of the present invention;

FIG. 2 is a top, front perspective view of the container for fragrant essence of the present invention;

FIG. 3 is a top plan view thereof;

FIG. 4 is a bottom plan view of the container for fragrant essence of the present invention; and,

FIG. 5 is a side view (orthogonal to the front perspective view of FIG. 2) of the container for fragrant essence of the present invention, with the opposing side being identical.

The broken lines in the drawings illustrate the portions of the design that form no part of the claim.

1 Claim, 5 Drawing Sheets

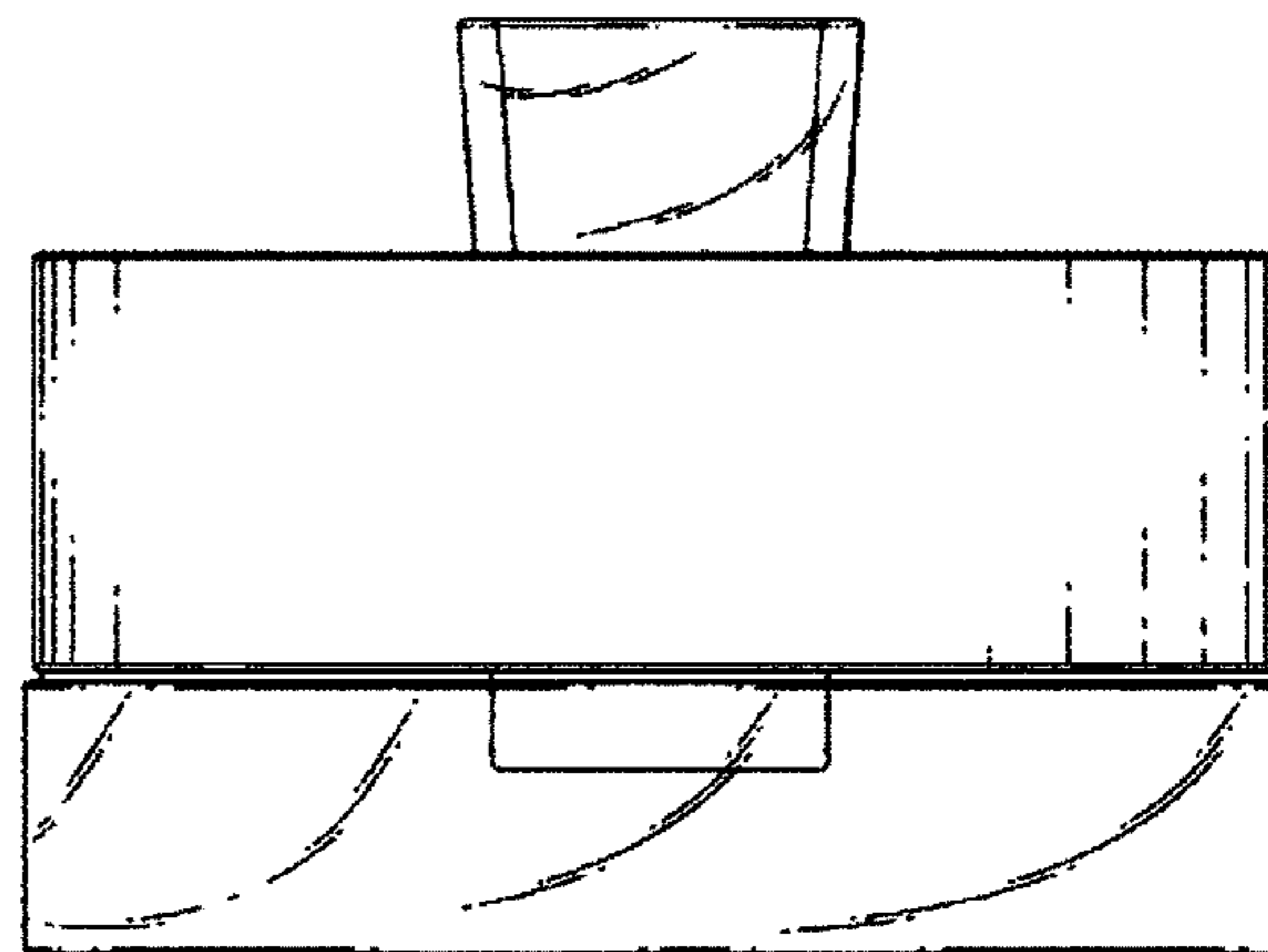
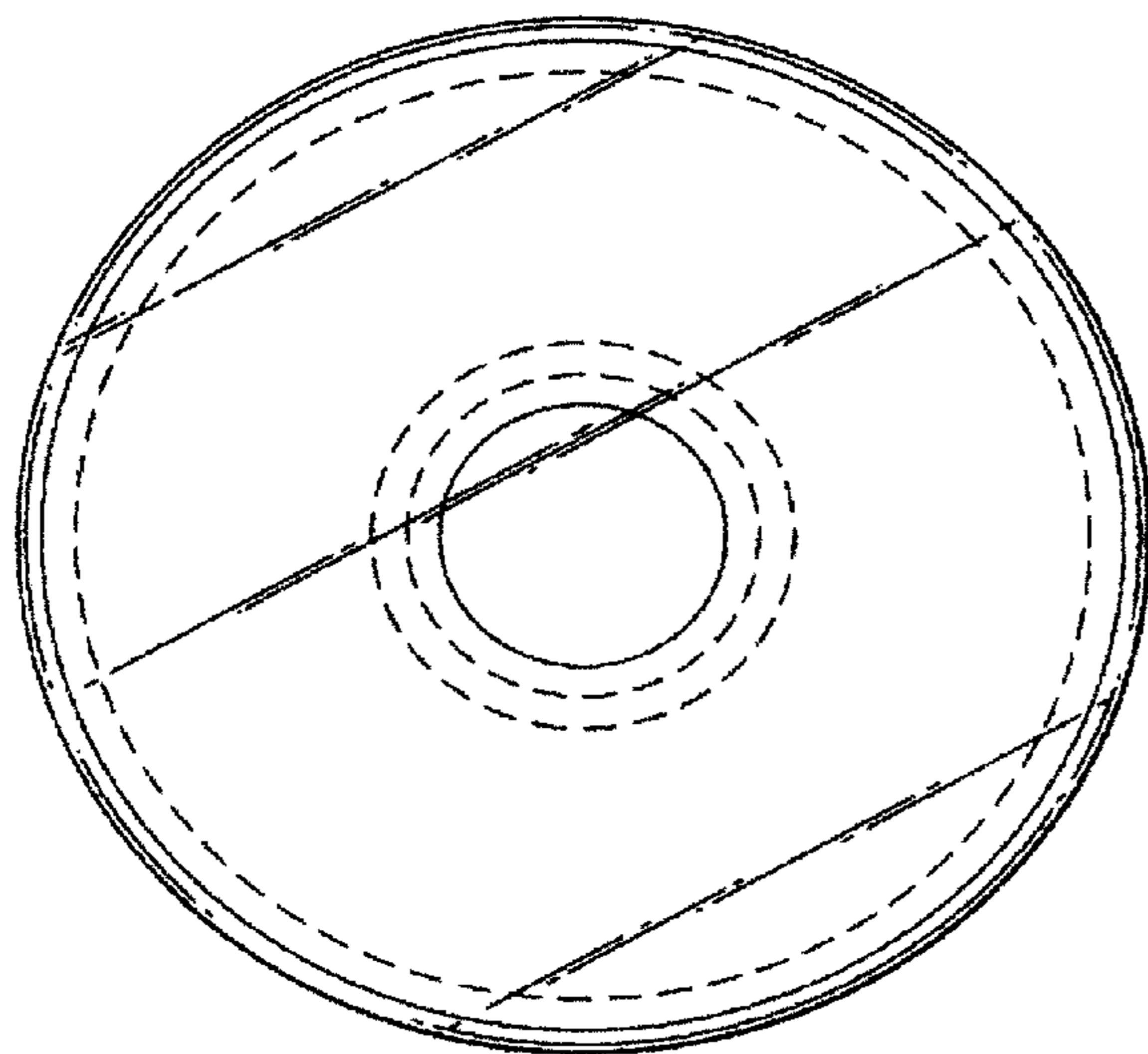

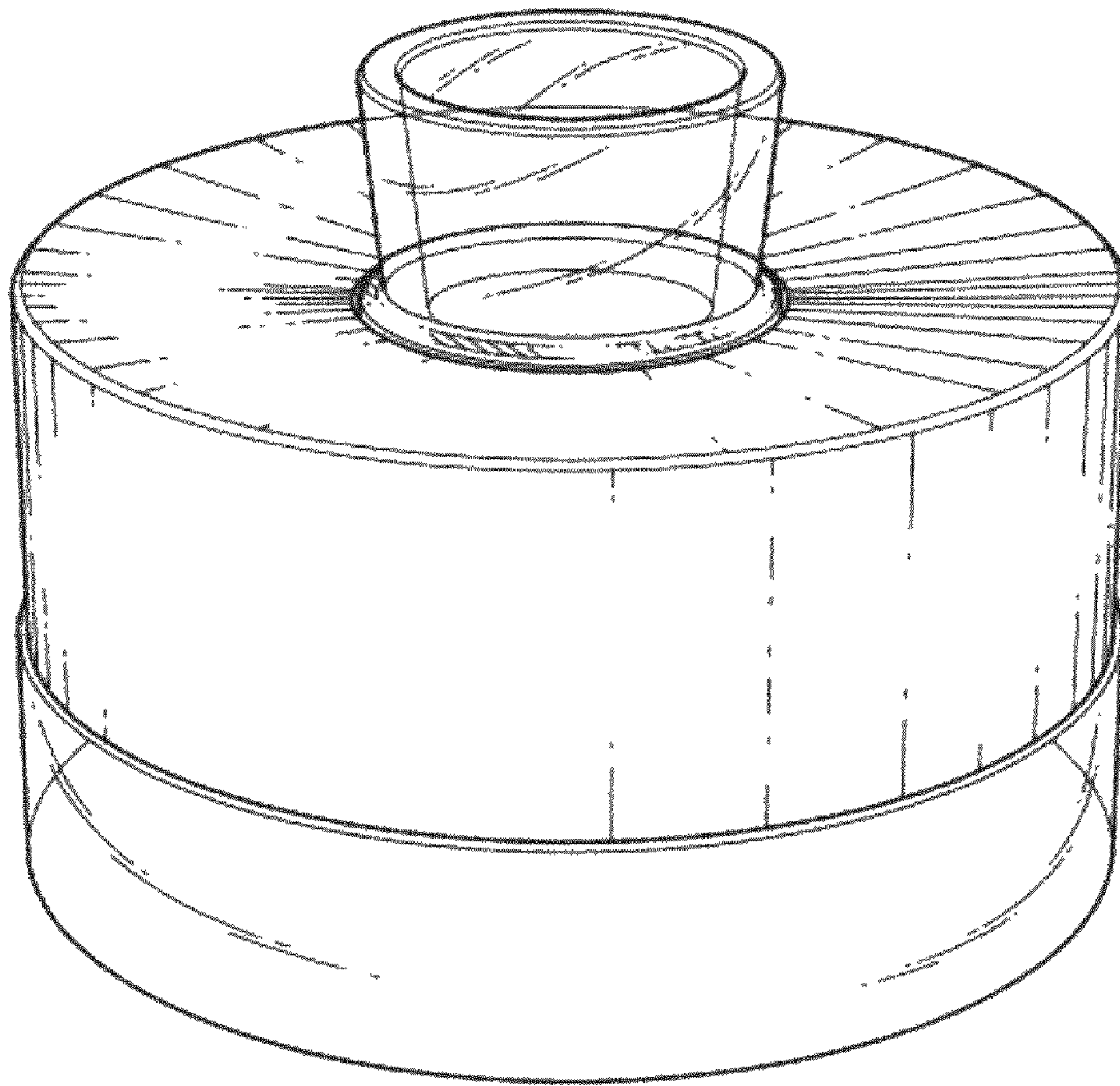

FIG. 1

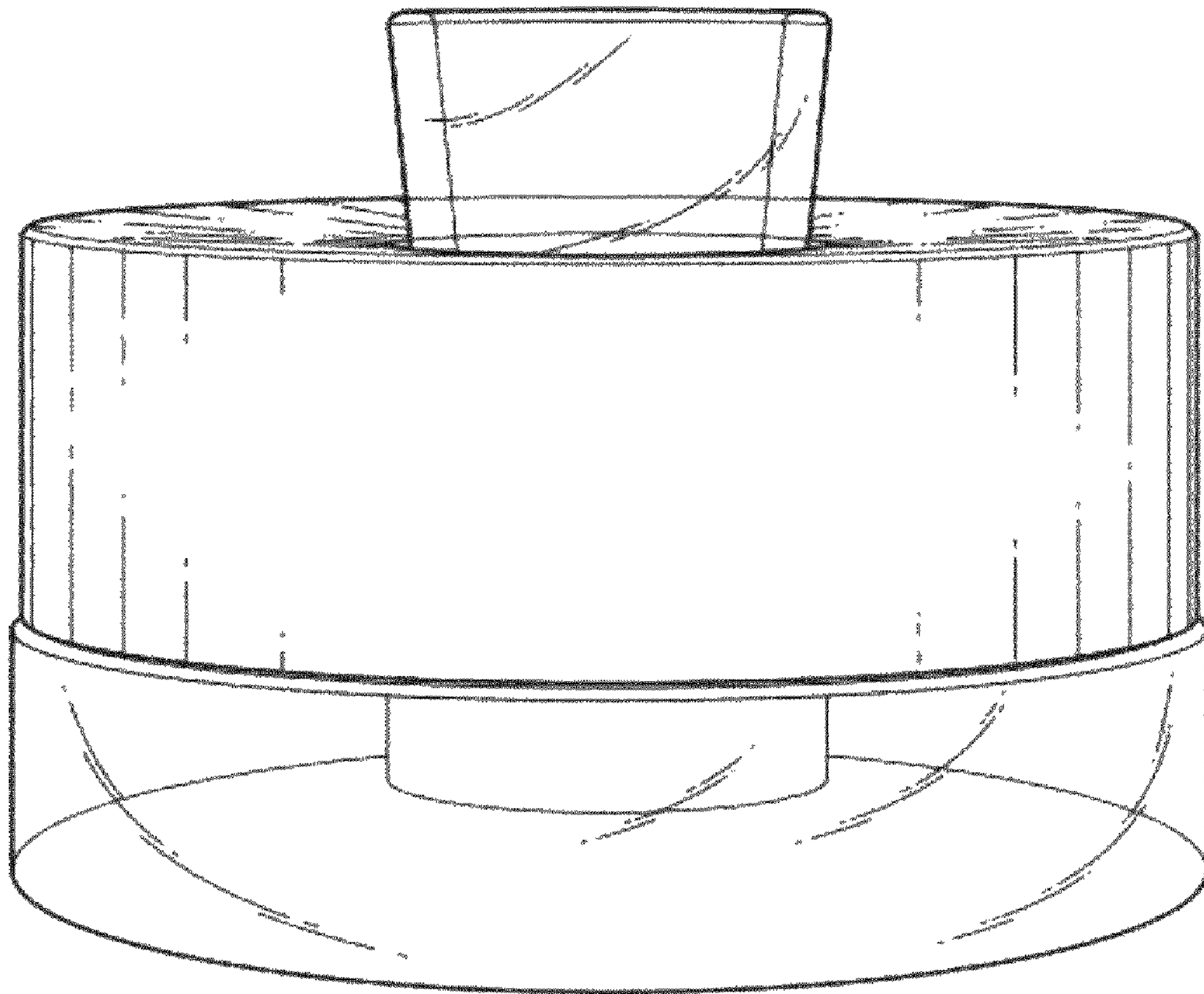

FIG. 2

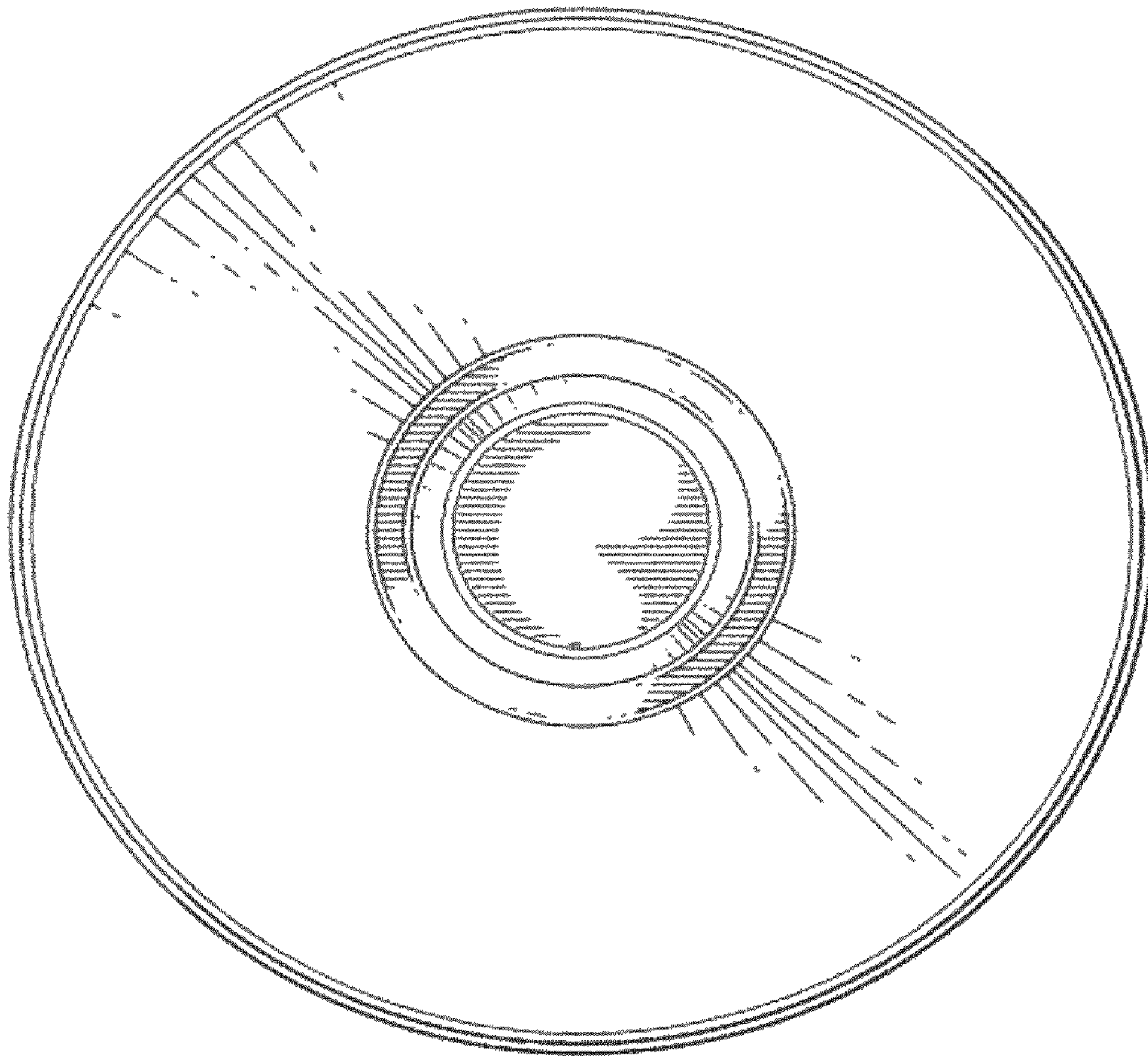

FIG. 3

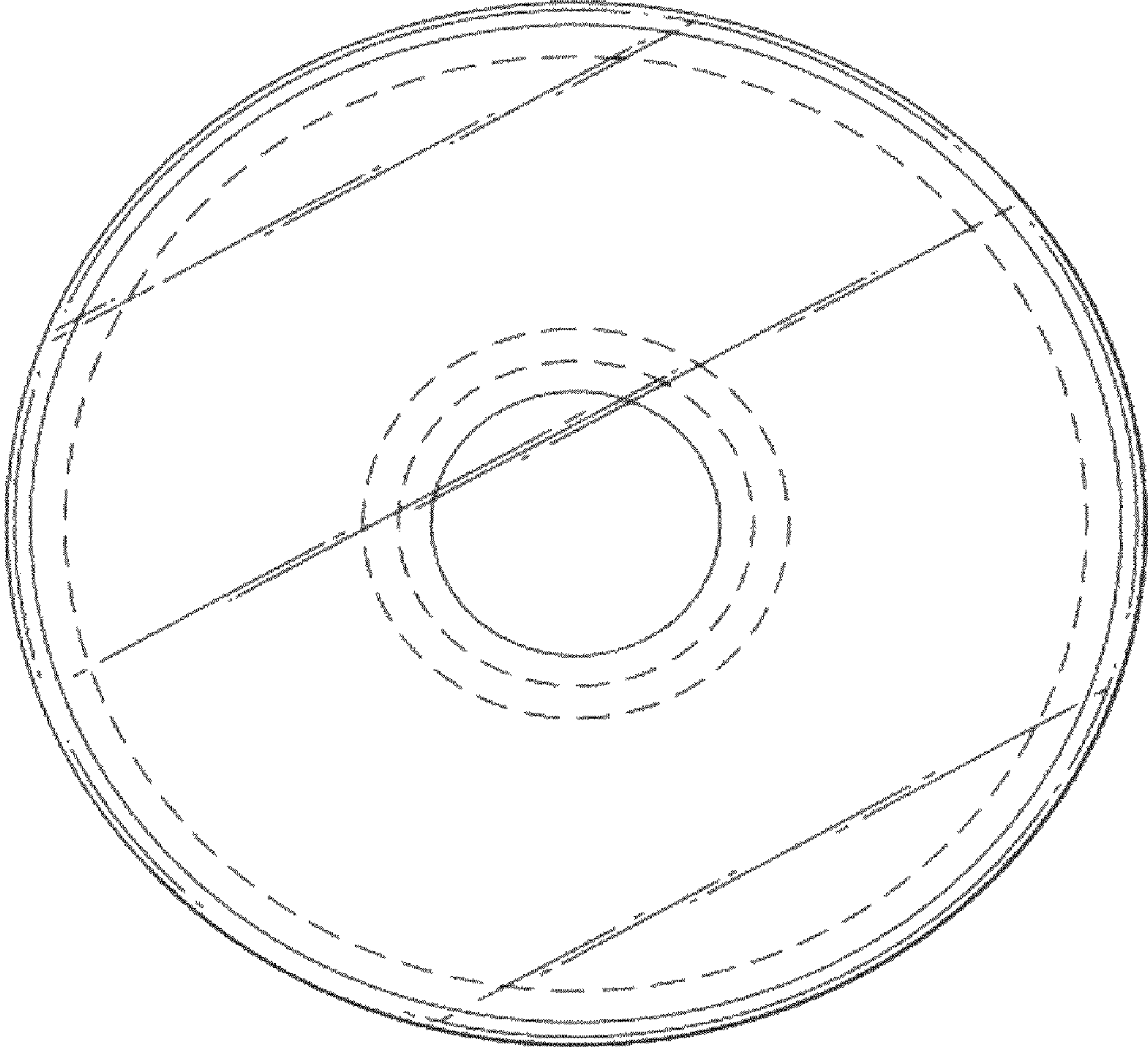

FIG. 4

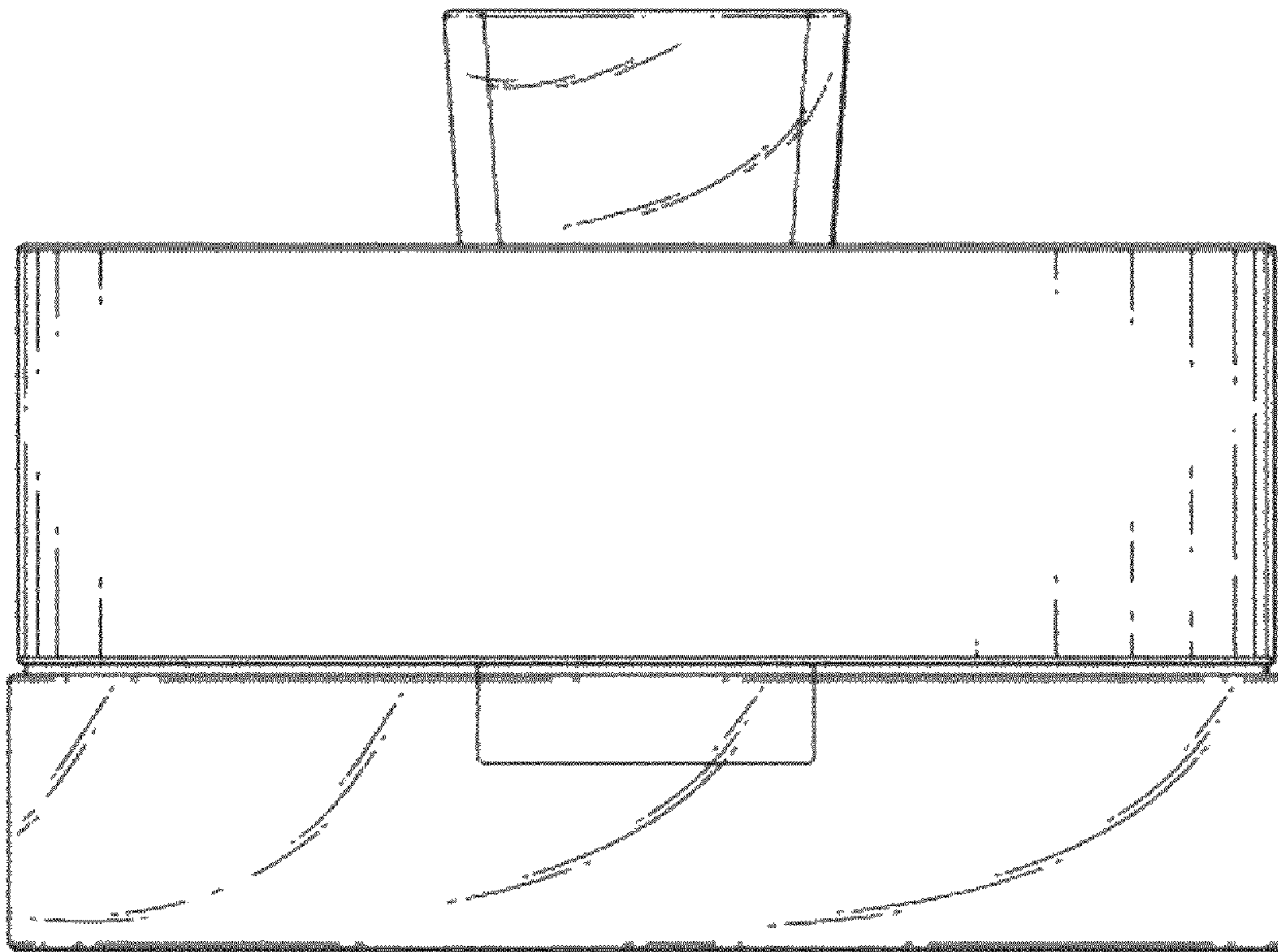

FIG. 5