



US00D659502S

(12) **United States Design Patent**
Wood

(10) **Patent No.:** **US D659,502 S**

(45) **Date of Patent:** **** May 15, 2012**

(54) **SCREWDRIVER BIT**

(76) **Inventor:** **Redmond Scott Wood**, Spencerville,
OH (US)

(**) **Term:** **14 Years**

(21) **Appl. No.:** **29/409,569**

(22) **Filed:** **Dec. 24, 2011**

(51) **LOC (9) Cl.** **08-04**

(52) **U.S. Cl.** **D8/86**

(58) **Field of Classification Search** D8/70,
D8/82, 85-87, 105; 81/125, 124.2, 436,
81/438-441, 460-461, 467, 489-490, 901
See application file for complete search history.

(56) **References Cited**

U.S. PATENT DOCUMENTS

1,296,165	A	12/1916	Costuma	
1,797,390	A	2/1929	Wood	
2,431,628	A *	11/1947	Waarich	81/436
2,800,936	A *	7/1957	West	81/460
3,175,593	A *	3/1965	Launay	81/436
3,673,912	A *	7/1972	Herr	411/403
3,695,321	A	10/1972	Garehime, Jr.	
3,891,017	A *	6/1975	Iskra	81/436
3,920,350	A *	11/1975	Southall	408/211
3,985,170	A *	10/1976	Iskra	81/438
4,130,152	A	12/1978	Bolen	
4,339,971	A	7/1982	Zatorre	
4,434,687	A *	3/1984	Vickio	81/441
4,528,874	A *	7/1985	Dunn	81/57.37
5,259,279	A	11/1993	Strauch	
5,353,667	A	10/1994	Wilner	
5,438,895	A *	8/1995	Bassell et al.	81/451
5,528,966	A *	6/1996	Coppejans	81/460
D371,946	S *	7/1996	Giblin	D8/82
5,582,548	A	12/1996	Czegledi	

D405,672	S *	2/1999	Wirths	D8/86
6,128,983	A *	10/2000	Arnn	81/460
6,193,242	B1 *	2/2001	Robison	279/137
D438,774	S *	3/2001	Huang et al.	D8/86
D446,436	S *	8/2001	Christianson	D8/105
D453,289	S *	2/2002	Campbell	D8/86
6,397,710	B1	6/2002	Baker	
D480,618	S	10/2003	Petsorich	
6,886,431	B1	5/2005	Petsorich	
7,028,592	B2 *	4/2006	Hills	81/436
7,325,470	B2	2/2008	Kay et al.	

* cited by examiner

Primary Examiner — Philip S Hyder

Assistant Examiner — Roselynn Cody

(74) *Attorney, Agent, or Firm* — Christopher Wood; Premier Law Group, PLLC

(57) **CLAIM**

The ornamental design for a screwdriver bit, as shown and described.

DESCRIPTION

FIG. 1 is a perspective top view of the screwdriver bit showing my new design;
FIG. 2 is a perspective bottom view thereof;
FIG. 3 is a top plan view thereof;
FIG. 4 is a bottom plan view thereof;
FIG. 5 is a front elevation view thereof;
FIG. 6 is a rear elevation view thereof;
FIG. 7 is a left side elevation view thereof; and
FIG. 8 is a right side elevation view thereof; and,
FIG. 9 is an illustrative perspective view thereof.
The broken lines shown in FIG. 9 are for illustrative purposes only and form no part of the claimed design.

1 Claim, 6 Drawing Sheets

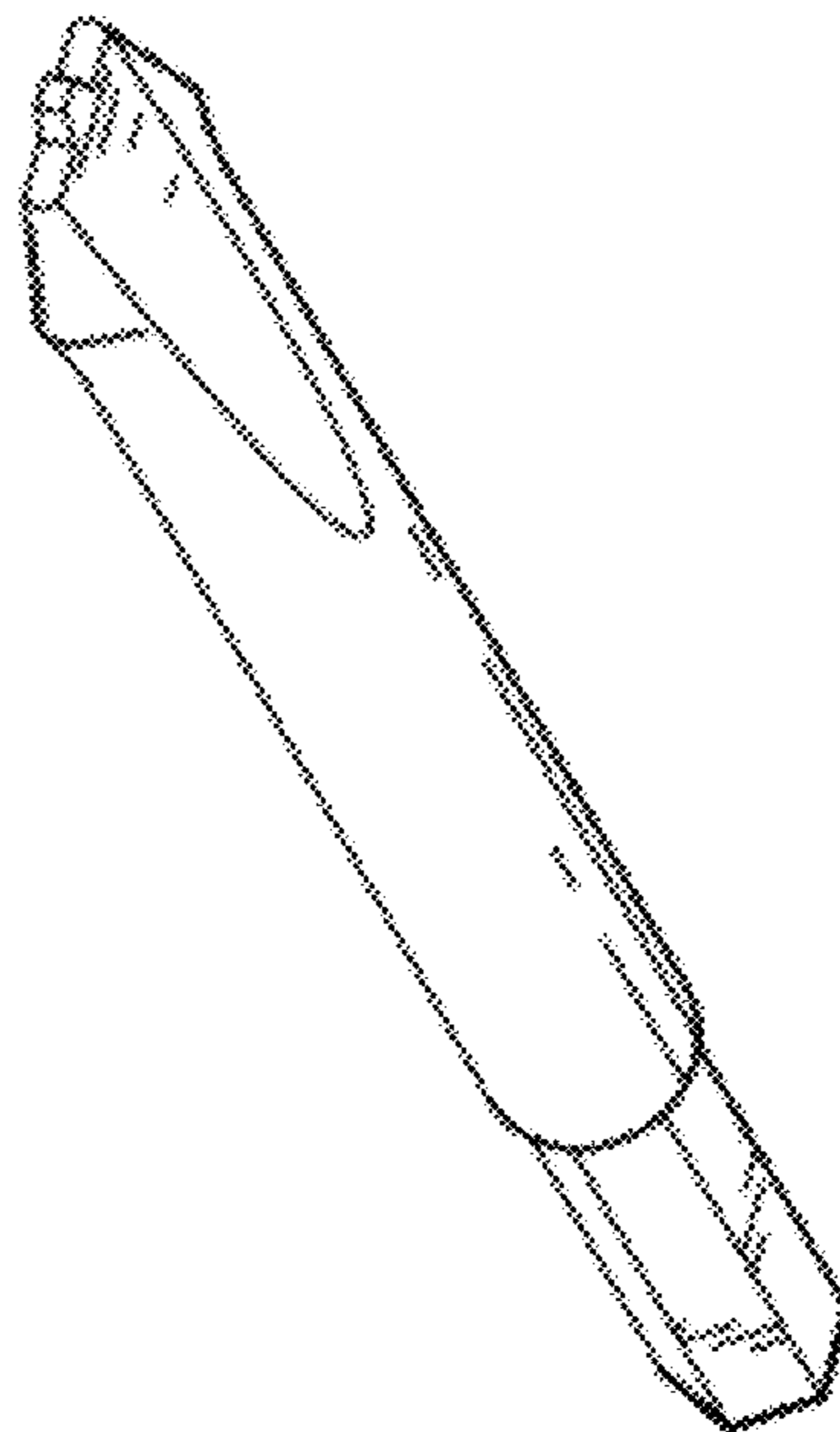
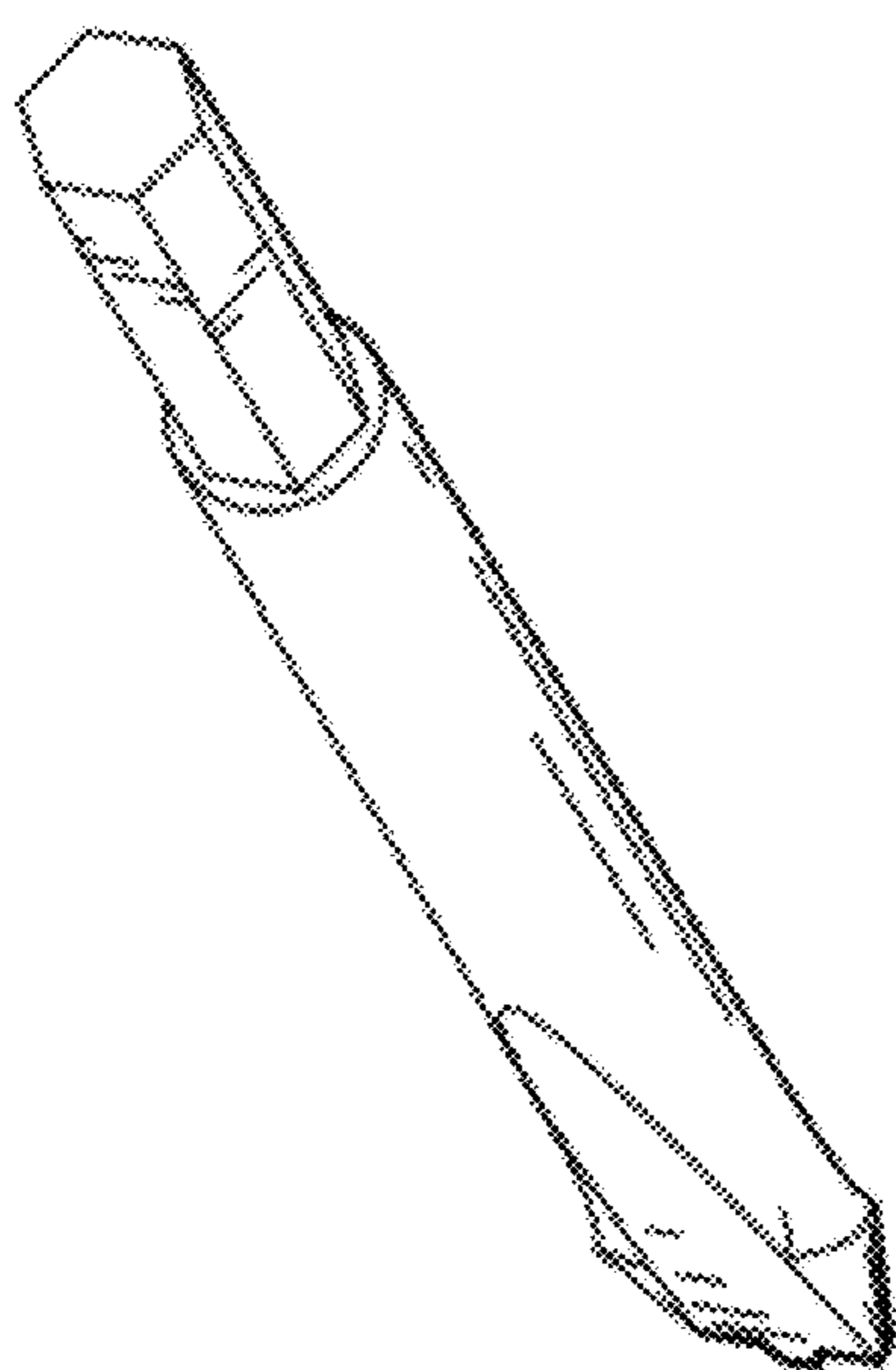

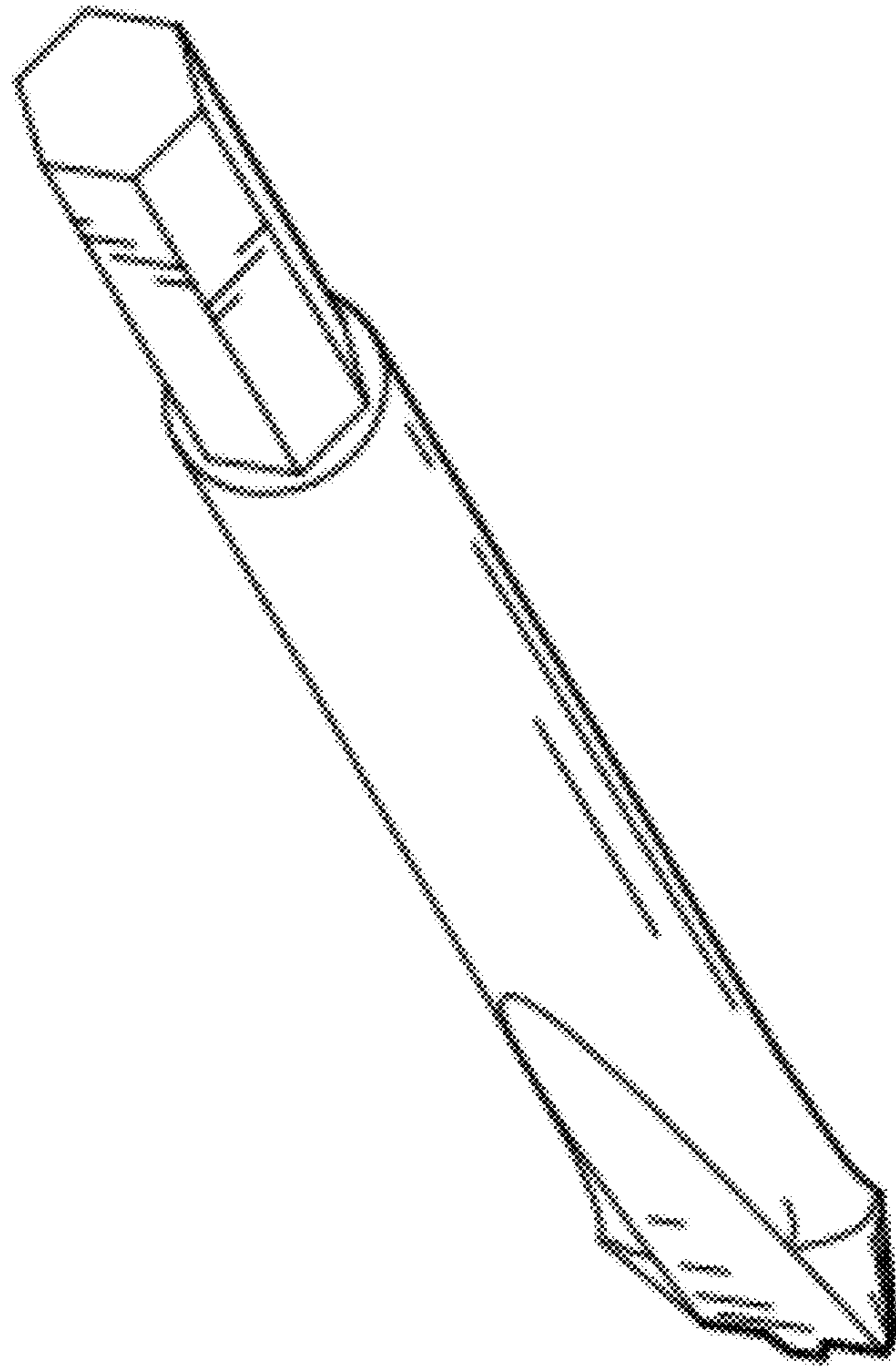

FIG. 1

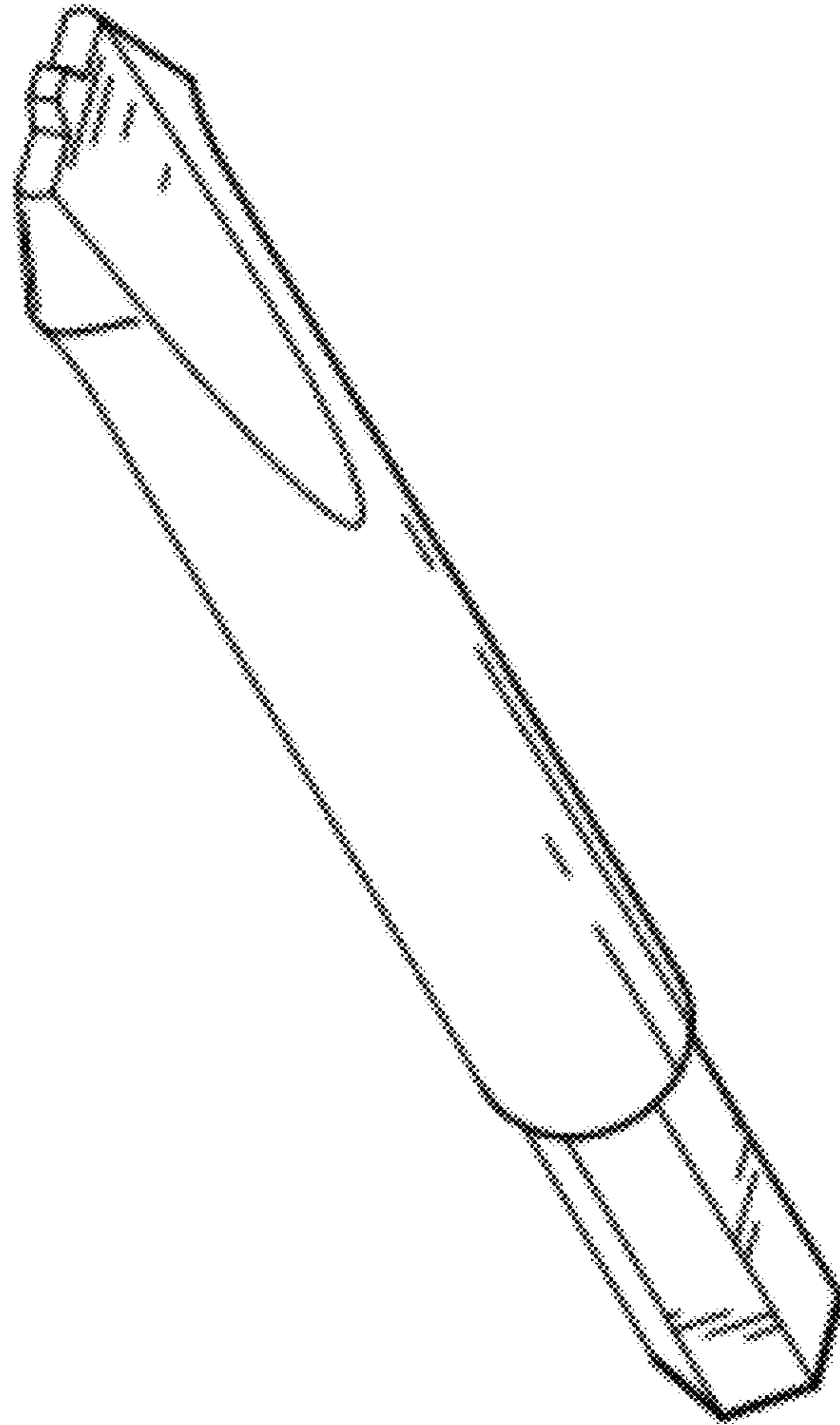

FIG. 2



FIG. 3

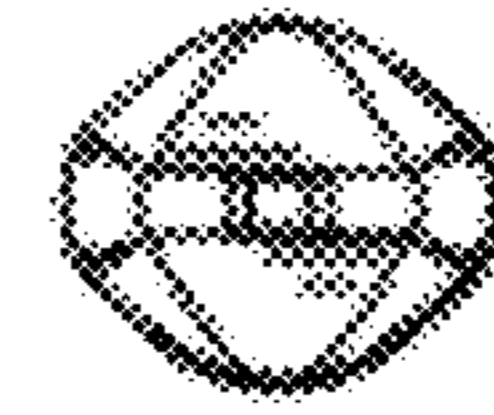

FIG. 4

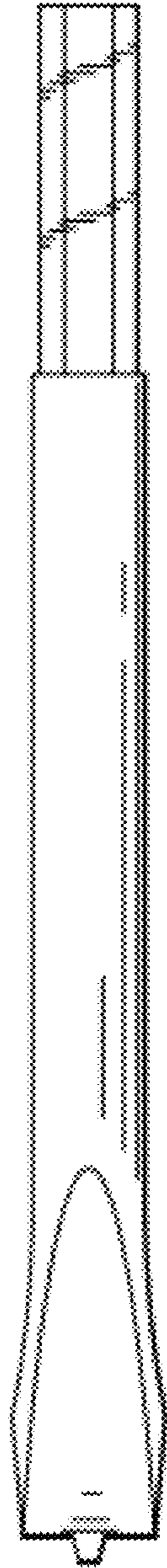

FIG. 5

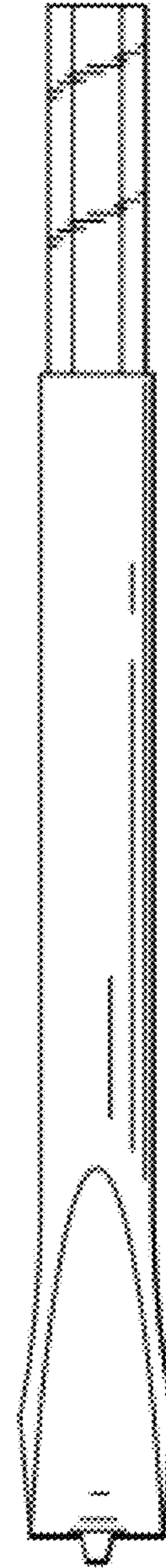

FIG. 6

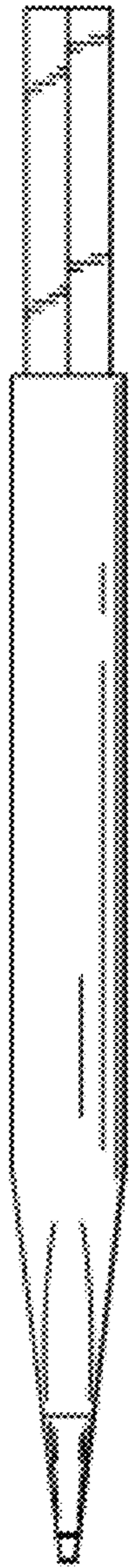

FIG. 7

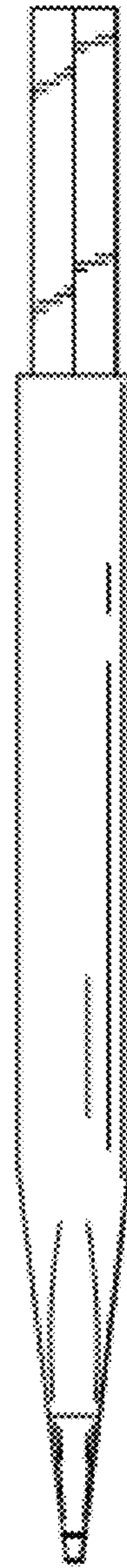

FIG. 8

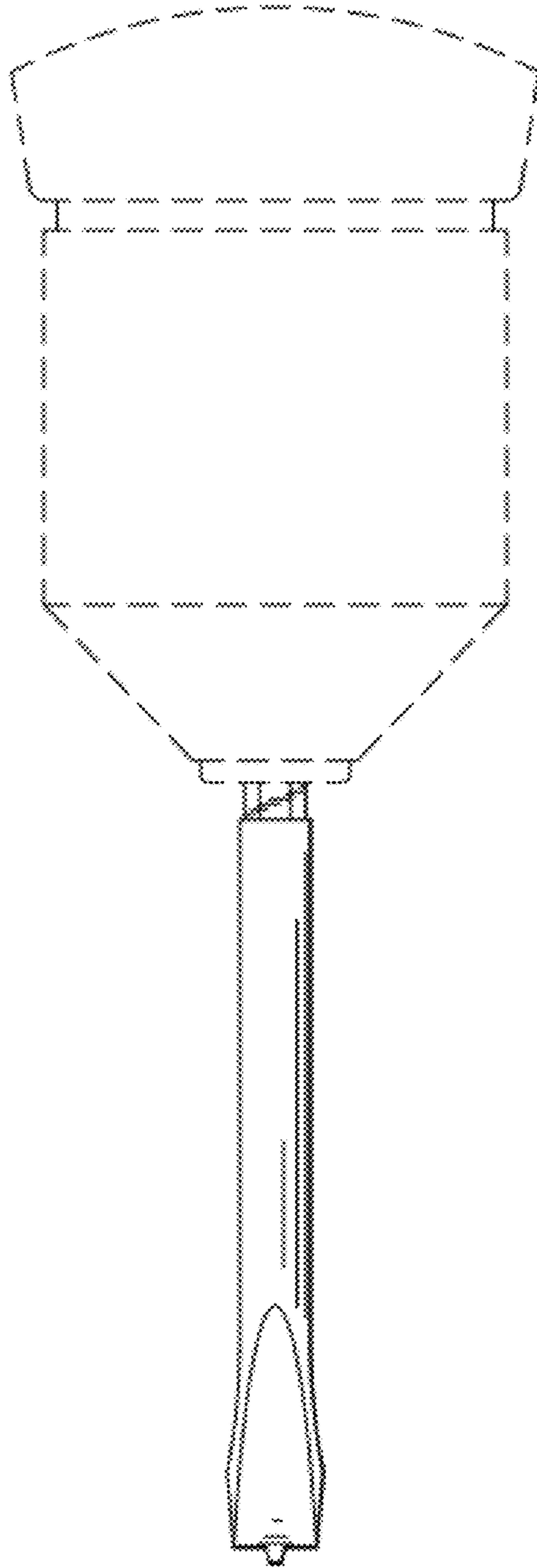

FIG. 9