



US00D659450S

(12) **United States Design Patent**
Winter et al.

(10) **Patent No.:** **US D659,450 S**

(45) **Date of Patent:** **** May 15, 2012**

- (54) **TABLE TOP SURFACE AND EDGE**
- (75) Inventors: **David C. Winter**, Layton, UT (US);
Wendell Peery, Kaysville, UT (US);
Mitch Johnson, South Weber, UT (US)
- (73) Assignee: **Lifetime Products, Inc.**, Clearfield, UT (US)
- (**) Term: **14 Years**
- (21) Appl. No.: **29/390,471**
- (22) Filed: **Apr. 25, 2011**
- (51) **LOC (9) Cl.** **06-06**
- (52) **U.S. Cl.** **D6/511**
- (58) **Field of Classification Search** D6/480-489,
D6/495-499, 429, 511; 108/150, 153.1,
108/156, 157.1, 161, 115, 124, 125, 129
See application file for complete search history.

- 7,707,947 B2 5/2010 Winter et al.
- D640,487 S 6/2011 Bennett
- 8,033,228 B2* 10/2011 Haney et al. 108/132
- 8,042,475 B2 10/2011 Larcom et al.
- 8,833,228 10/2011 Haney et al.

OTHER PUBLICATIONS

- U.S. App. No. 12/110,163, filed Apr. 25, 2008, VanNimwegen et al.
- U.S. App. No. 29/391,721, filed May 12, 2011, Bennett.
- U.S. App. No. 29/403,327, filed Oct. 04, 2011, Winter et al.
- U.S. App. No. 13/270,141, filed Oct. 10, 2011, Haney et al.

* cited by examiner

Primary Examiner — Janice Seeger

(74) *Attorney, Agent, or Firm* — Maschoff Gilmore & Israelsen

(57) **CLAIM**

The ornamental design for a table top surface and edge, as shown and described.

DESCRIPTION

FIG. 1 is an upper perspective view of a table top surface and edge;
 FIG. 2 is a top view of the table top surface and edge shown in FIG. 1;
 FIG. 3 is a side view of the table top surface and edge shown in FIG. 1;
 FIG. 4 is a lower perspective view of the table top surface and edge shown in FIG. 1; and,
 FIG. 5 is a cross-sectional side view along lines 5-5 of the table top surface and edge shown in FIG. 1.
 The broken lines shown in the figures are for illustrative purposes only and form no part of the claimed design.

1 Claim, 4 Drawing Sheets

- (56) **References Cited**
- U.S. PATENT DOCUMENTS
- D345,480 S * 3/1994 Sandegren D6/511
- D414,626 S 10/1999 Collins et al.
- 6,112,674 A 9/2000 Stanford
- D468,135 S 1/2003 Ashby et al.
- D487,205 S * 3/2004 Mower et al. D6/491
- D489,557 S * 5/2004 Strong et al. D6/511
- D499,283 S 12/2004 Winter et al.
- 7,069,865 B2 7/2006 Strong et al.
- 7,096,799 B2 8/2006 Strong et al.
- 7,171,910 B2* 2/2007 Neunzert et al. 108/132
- 7,178,471 B2* 2/2007 Strong et al. 108/132
- 7,299,754 B2 11/2007 Stanford et al.
- 7,475,644 B2* 1/2009 Strong et al. 108/132
- 7,634,970 B2* 12/2009 Strong et al. 108/132

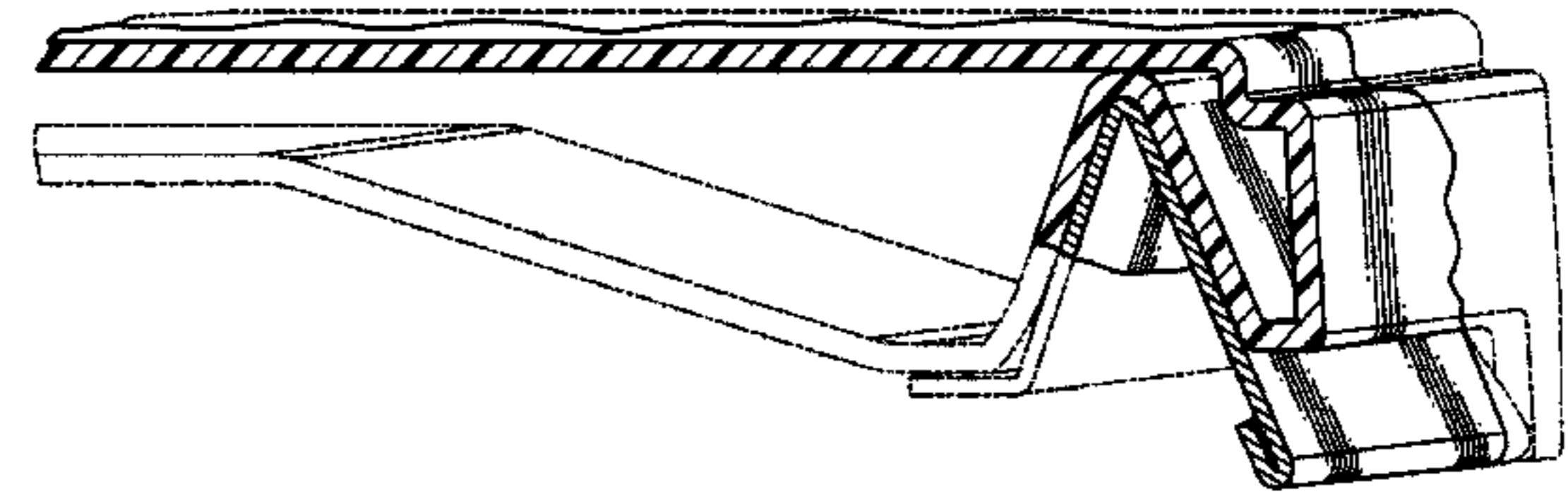
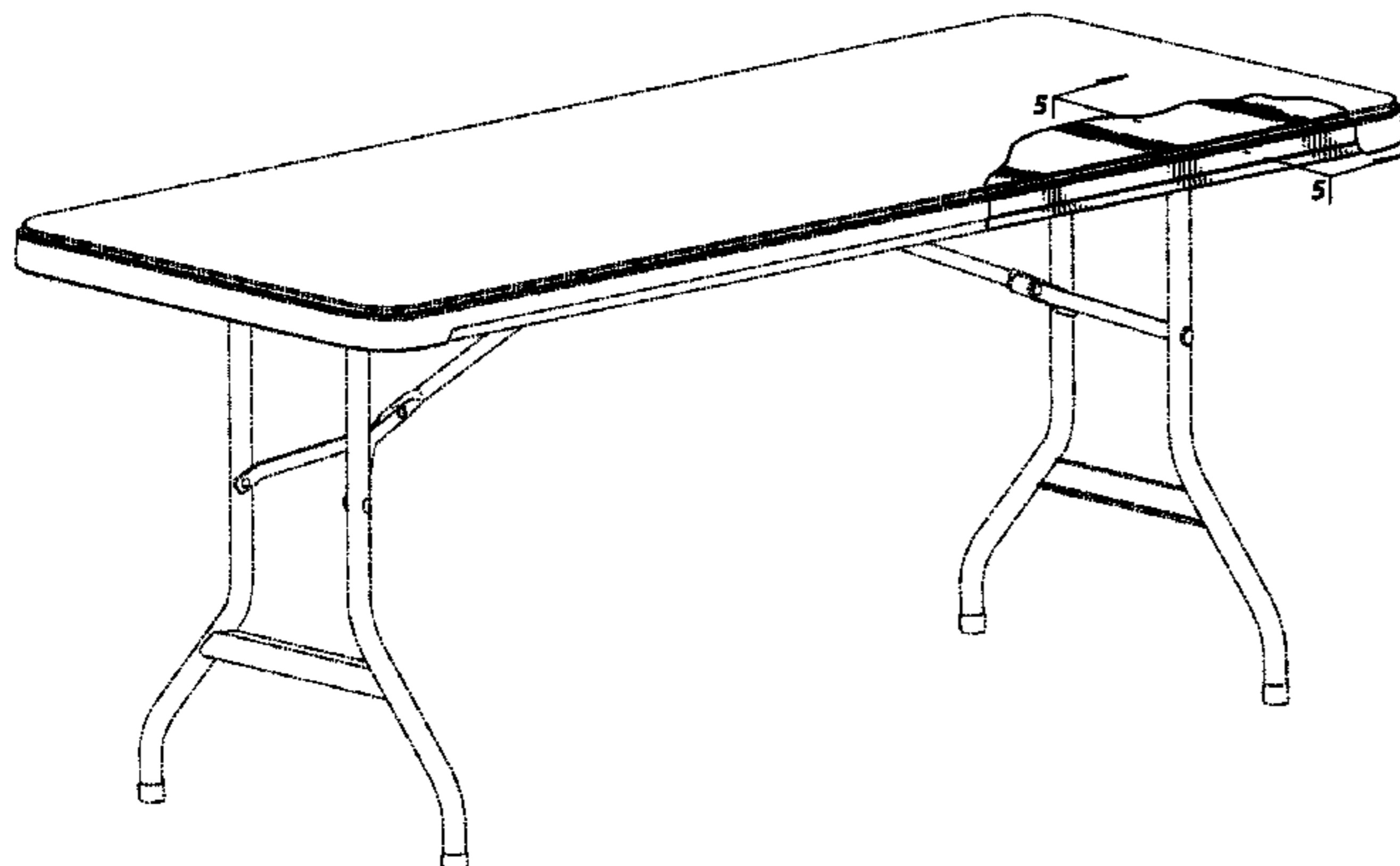

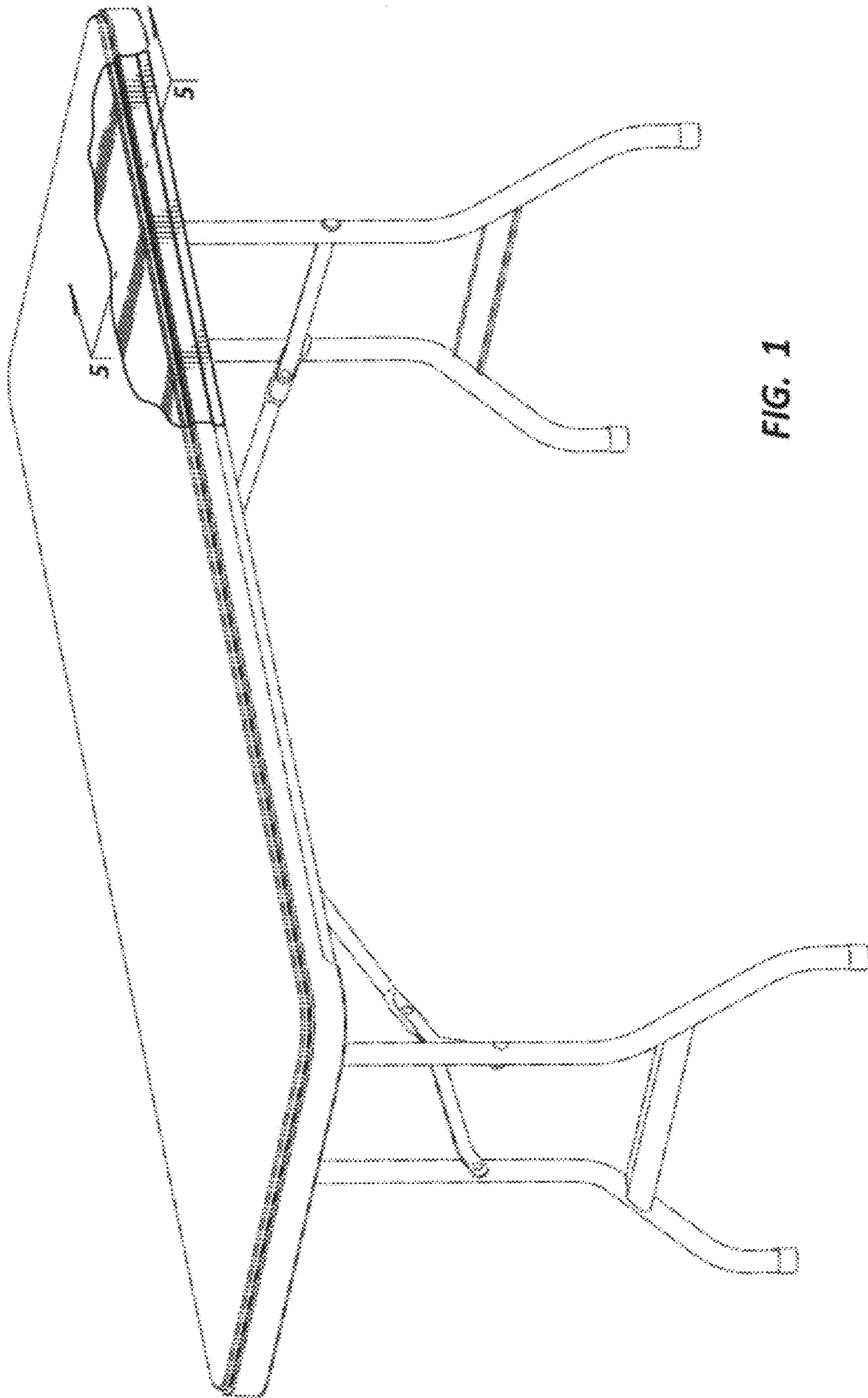
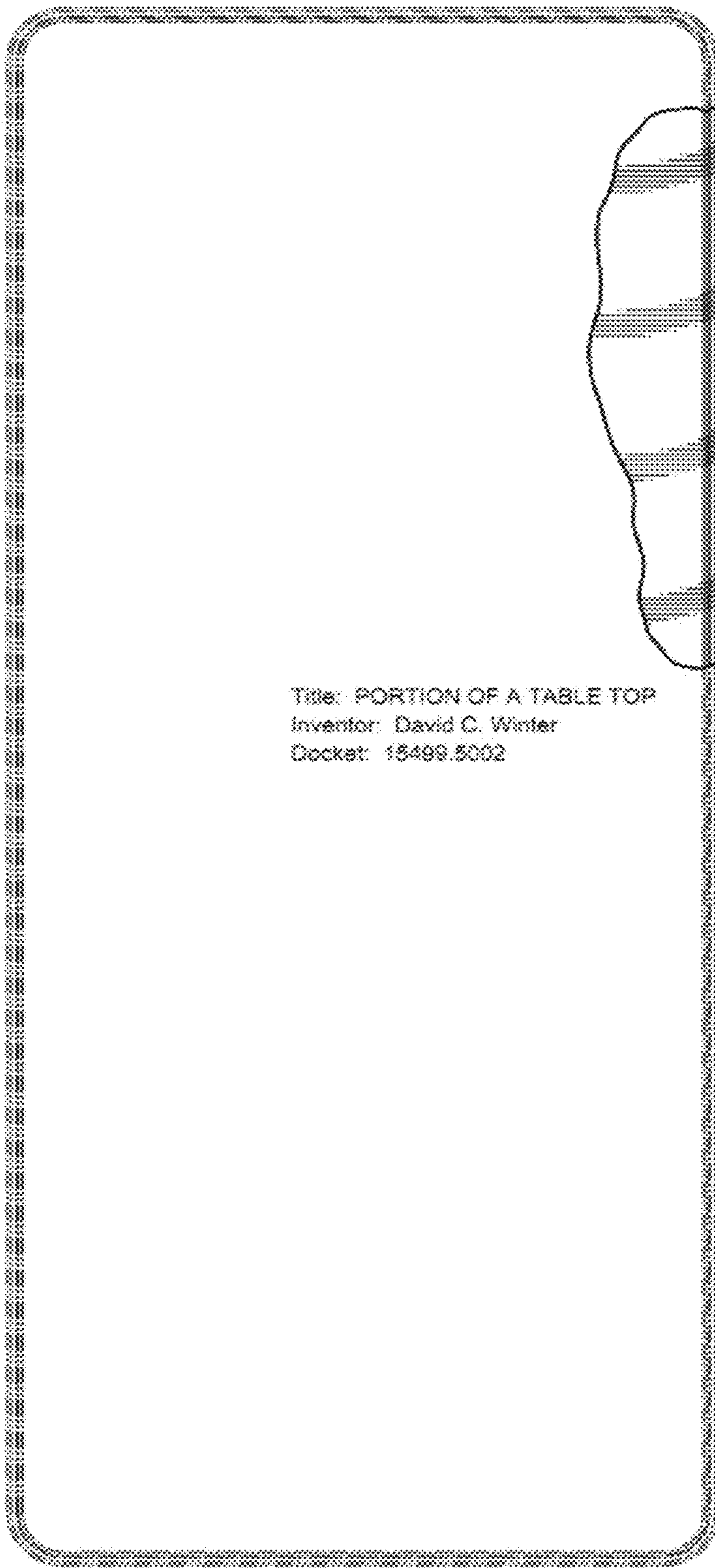

FIG. 1



Title: PORTION OF A TABLE TOP
Inventor: David C. Winter
Docket: 15489.5002

FIG. 2

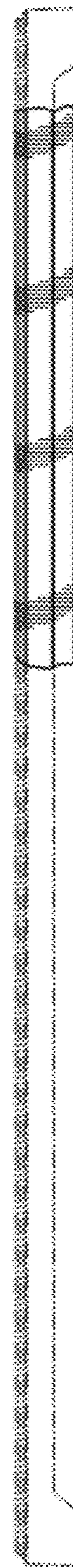

FIG. 3

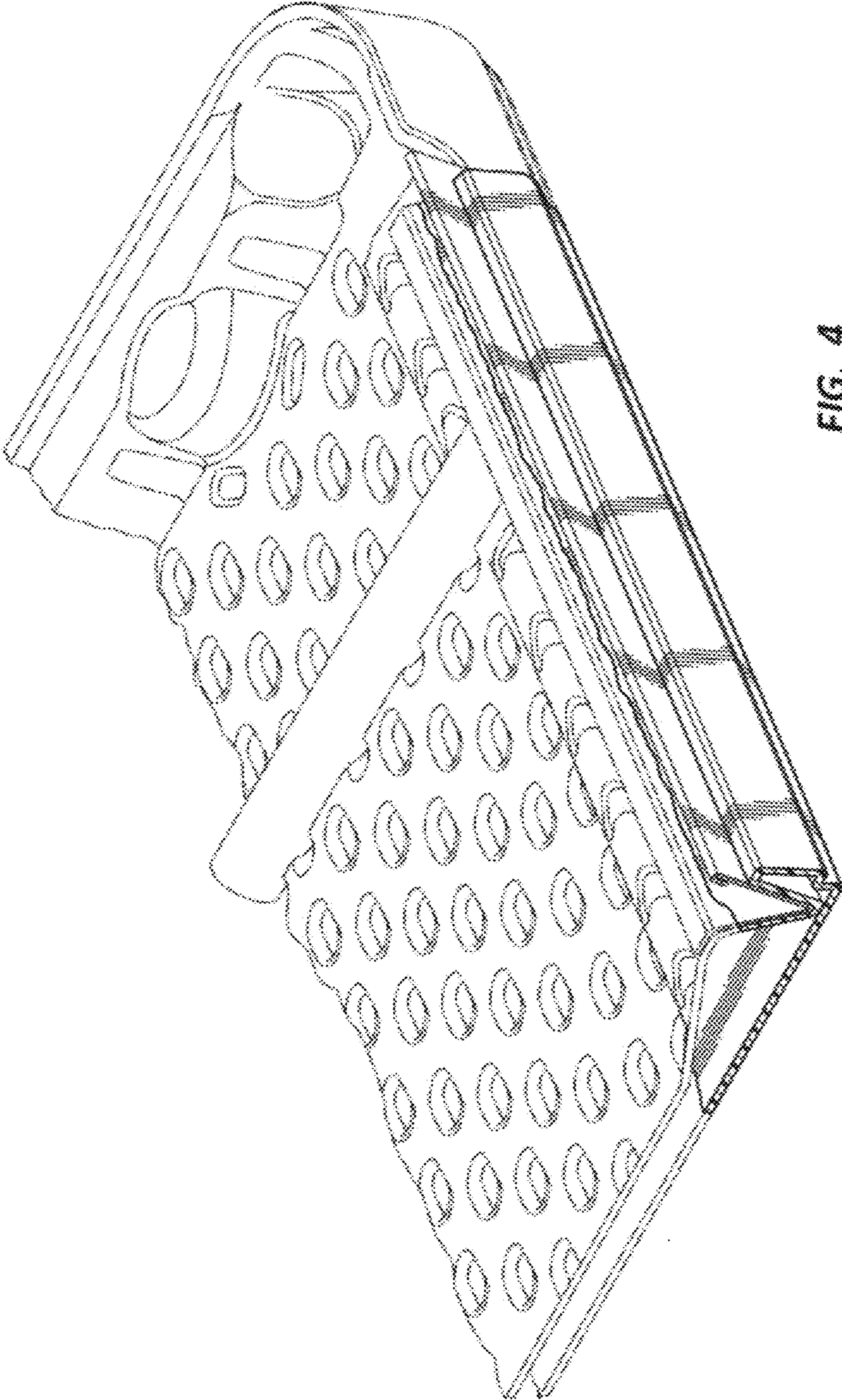

FIG. 4

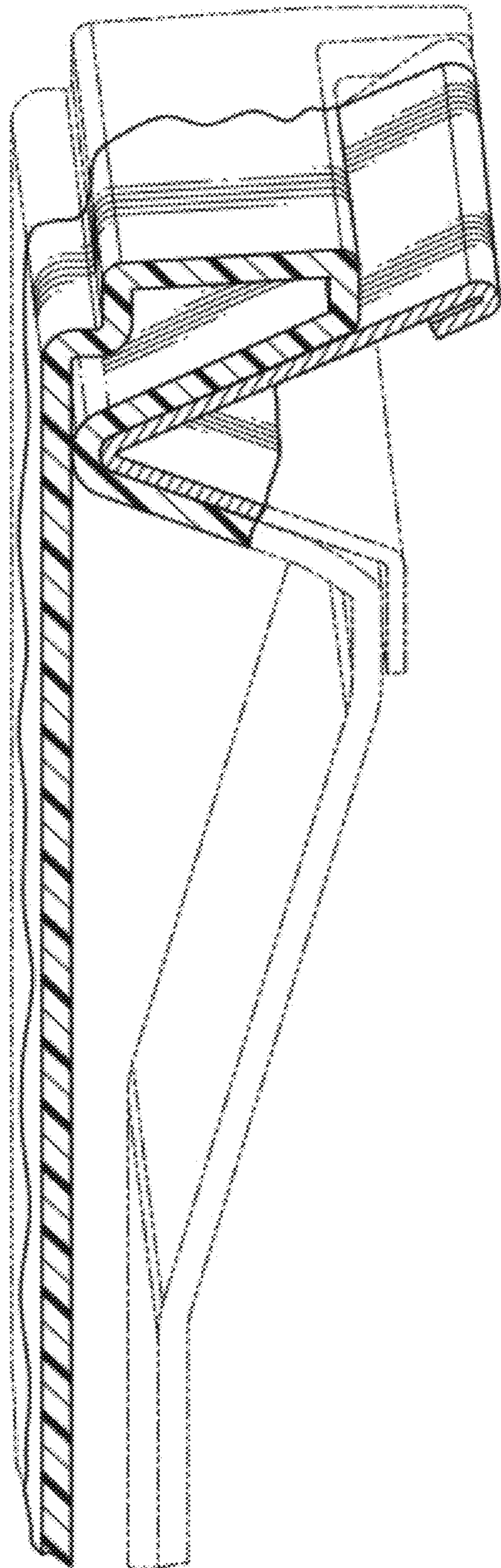

FIG. 5

UNITED STATES PATENT AND TRADEMARK OFFICE
CERTIFICATE OF CORRECTION

PATENT NO. : D659,450 S
APPLICATION NO. : 29/390471
DATED : May 15, 2012
INVENTOR(S) : Winter et al.

Page 1 of 2

It is certified that error appears in the above-identified patent and that said Letters Patent is hereby corrected as shown below:

In the drawings, Fig. 2 of sheet 2 of 4 should be deleted and replaced with the attached corrected Fig. 2.

Signed and Sealed this
Seventh Day of August, 2012

A handwritten signature in black ink that reads "David J. Kappos". The signature is written in a cursive style with a large initial "D" and "K".

David J. Kappos
Director of the United States Patent and Trademark Office

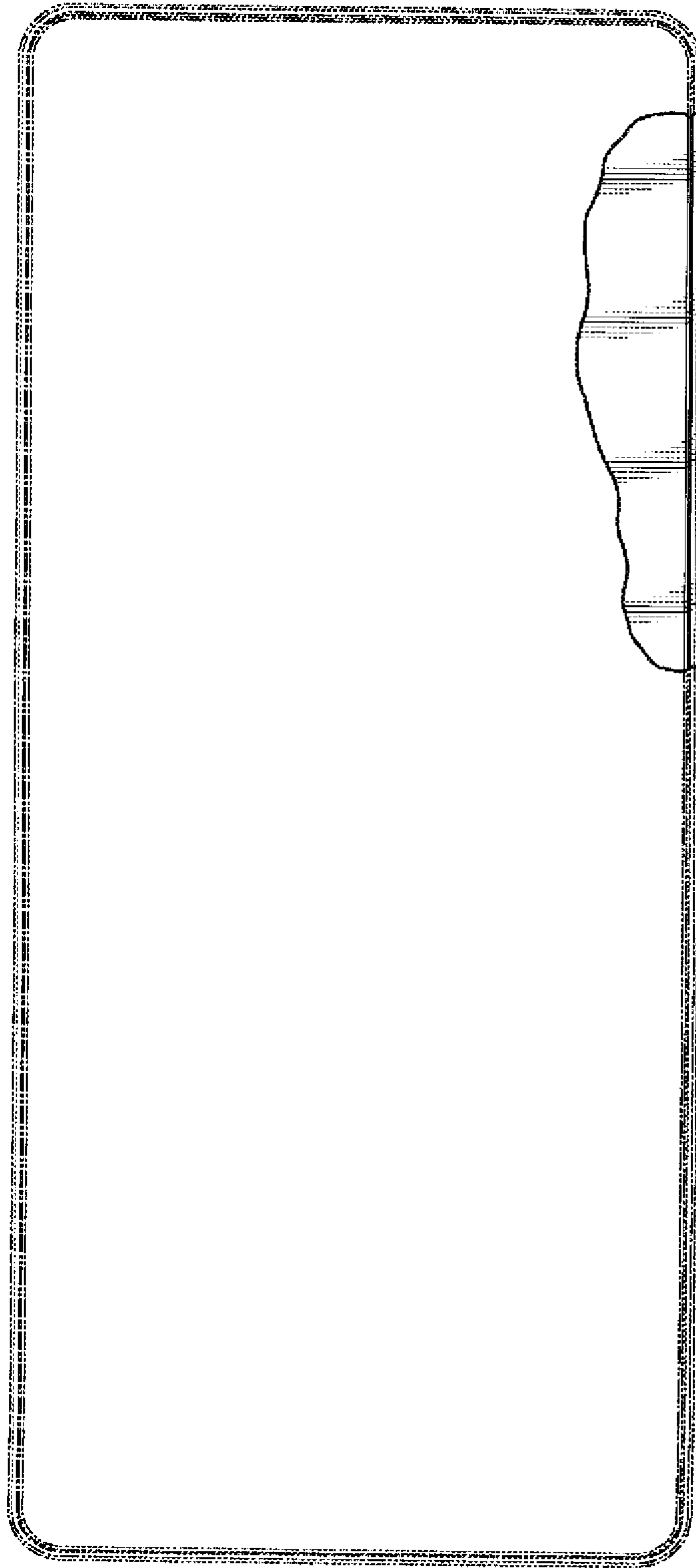

FIG. 2