



US00D659433S

(12) **United States Design Patent**
Starck

(10) **Patent No.:** **US D659,433 S**

(45) **Date of Patent:** **** May 15, 2012**

(54) **TABLE**

(75) Inventor: **Philippe Starck**, Paris (FR)

(73) Assignee: **Dedon GmbH**, Luneburg (DE)

(**) Term: **14 Years**

(21) Appl. No.: **29/389,498**

(22) Filed: **Apr. 12, 2011**

(30) **Foreign Application Priority Data**

Dec. 13, 2010 (EM) 001792508-0001

(51) **LOC (9) Cl.** **06-03**

(52) **U.S. Cl.** **D6/480**

(58) **Field of Classification Search** D6/480-489,
D6/495-499, 429, 511; 108/150, 153.1,
108/156, 157.1, 161, 144.11, 147.19, 25,
108/26, 50.01, 50.02; 248/188, 188.1, 188.7,
248/188.8

See application file for complete search history.

(56) **References Cited**

U.S. PATENT DOCUMENTS

D164,075 S * 7/1951 Wallance D6/480
2,719,717 A * 10/1955 Verity 273/126 R

3,228,359 A * 1/1966 Rich, Jr. 108/156
3,289,616 A * 12/1966 Donihi 108/161
3,290,108 A * 12/1966 Beckman et al. 312/281
D207,972 S * 6/1967 Bellaire D25/68
3,364,882 A * 1/1968 Merrick 108/25
7,926,430 B2 * 4/2011 Bakker et al. 108/50.02
2002/0129746 A1 * 9/2002 Donnelly 108/25
2010/0242808 A1 * 9/2010 Negoro et al. 108/42

* cited by examiner

Primary Examiner — Janice Seeger

(74) *Attorney, Agent, or Firm* — C. Brandon Browning;
Maynard Cooper & Gale, PC

(57) **CLAIM**

The ornamental design for a table, as shown and described.

DESCRIPTION

FIG. 1 is a perspective view of a table in accordance with the present invention.

FIG. 2 is a front elevational view of the table of FIG. 1.

FIG. 3 is a side elevational view of the table of FIG. 1.

FIG. 4 is a side elevational view of the table of FIG. 1.

FIG. 5 is a top plan view of the table of FIG. 1; and,

FIG. 6 is a bottom plan view of the table of FIG. 1.

1 Claim, 5 Drawing Sheets

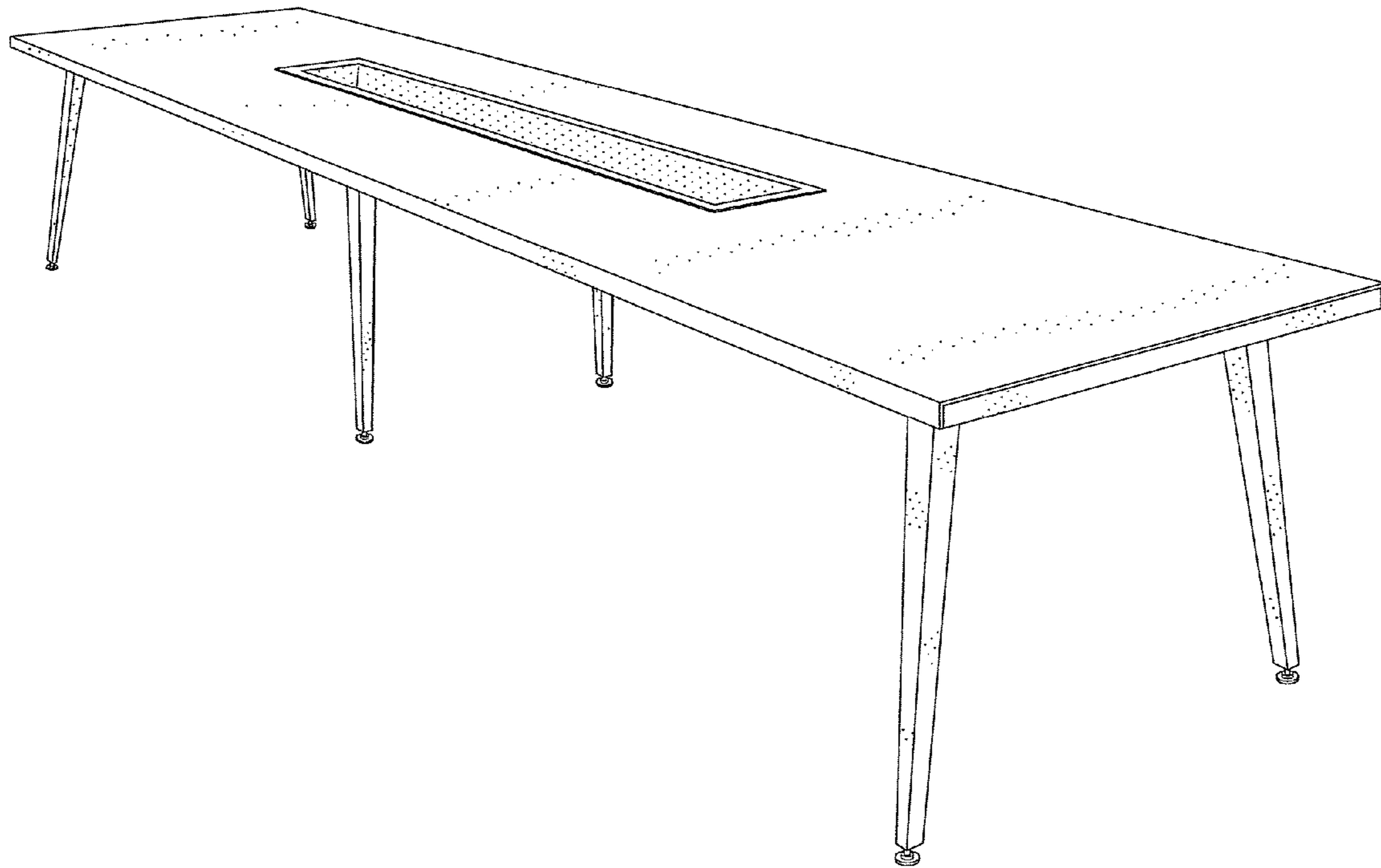

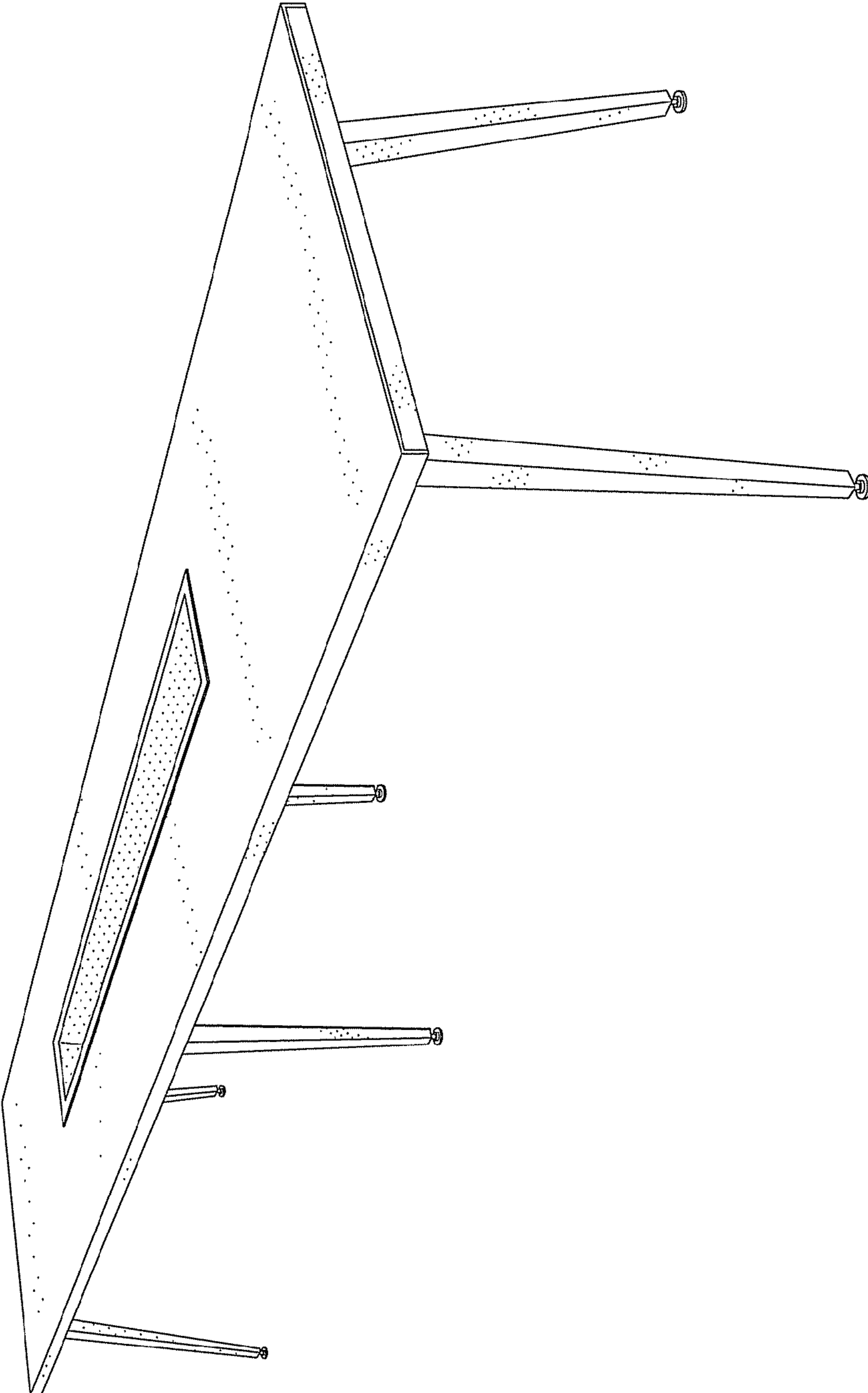

FIG. 1

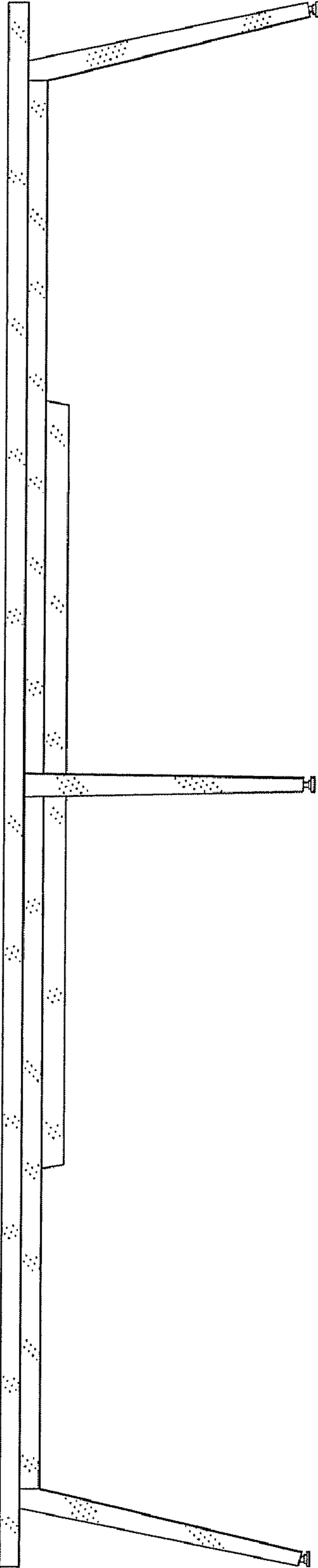

FIG. 2

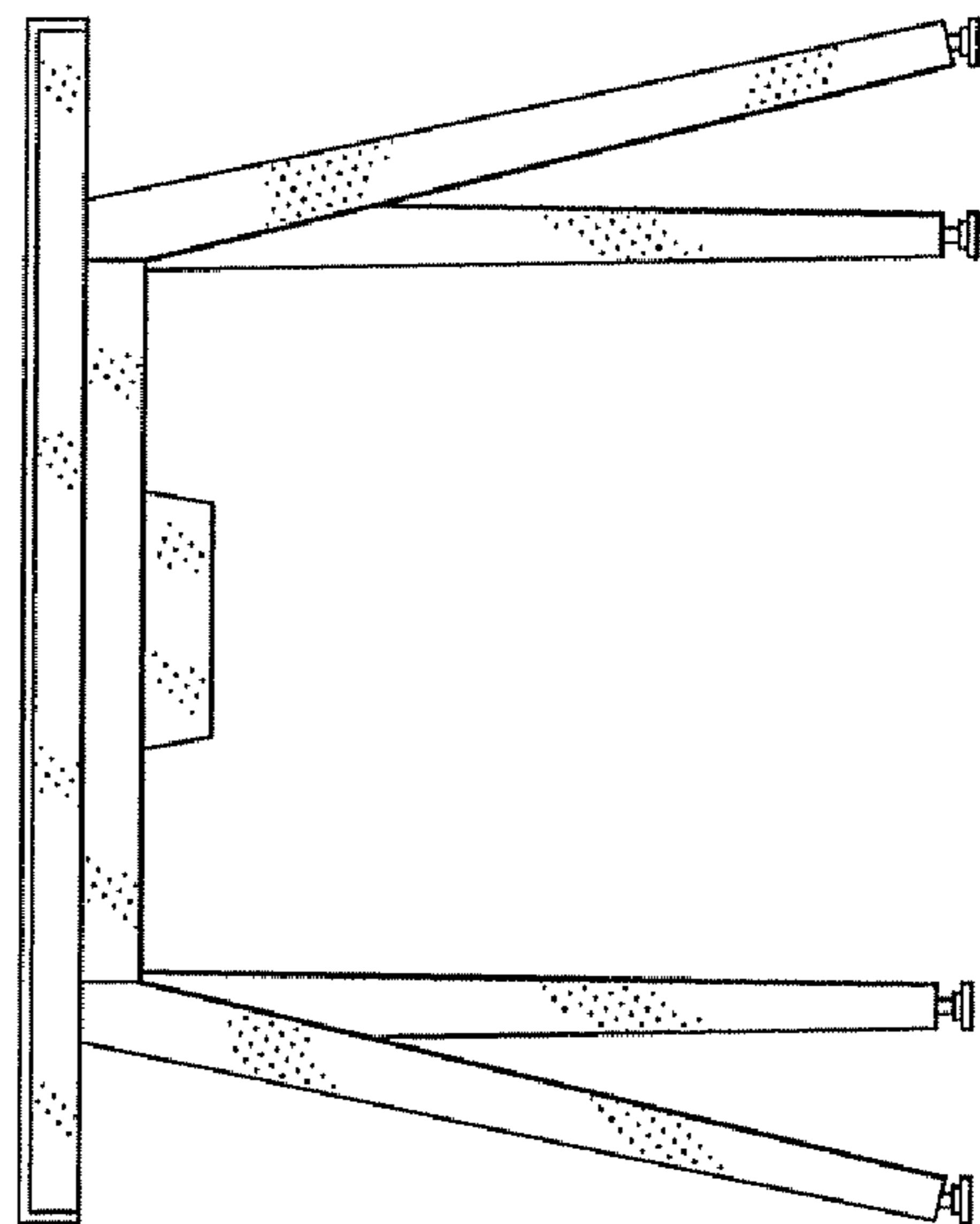

FIG. 4

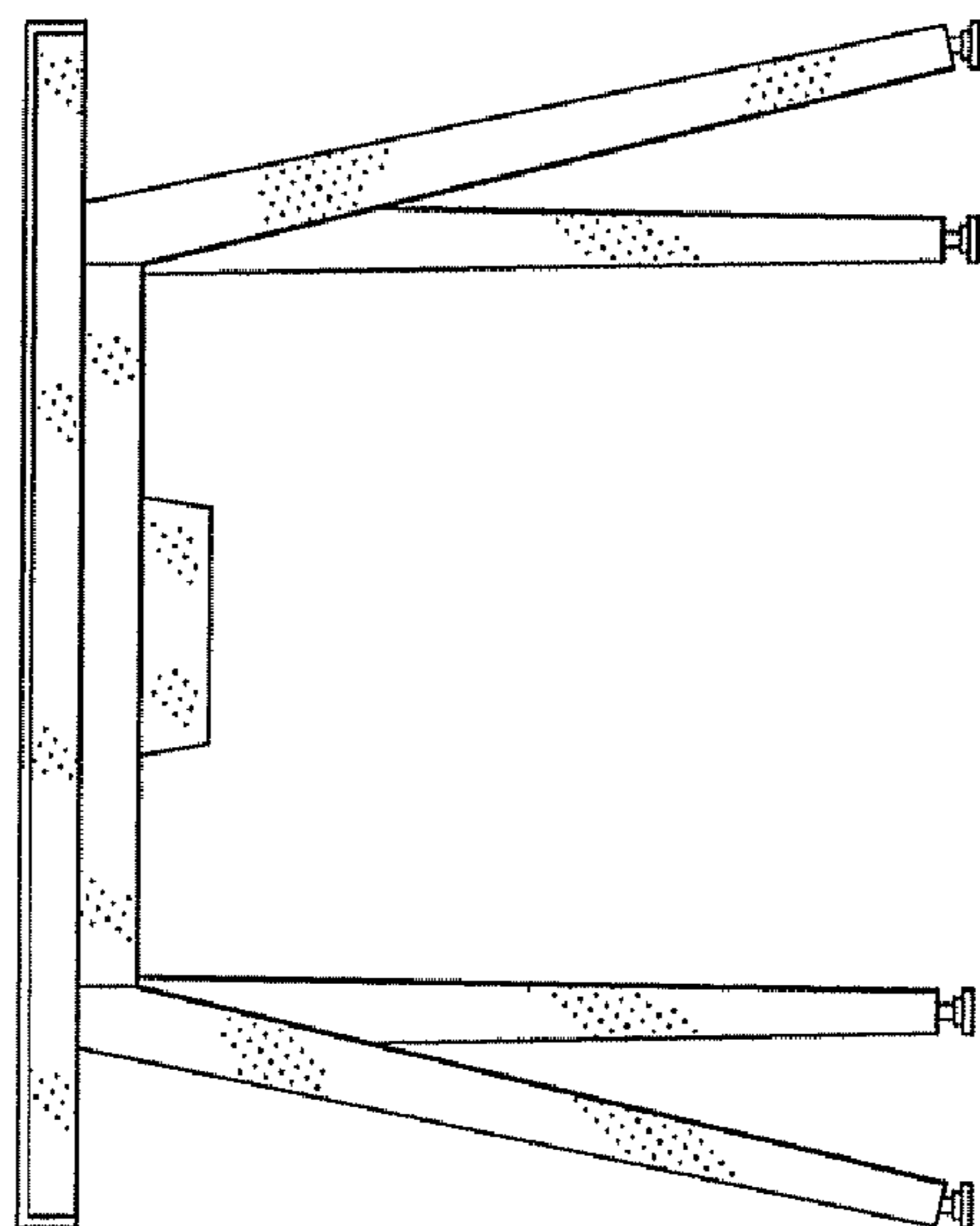

FIG. 3

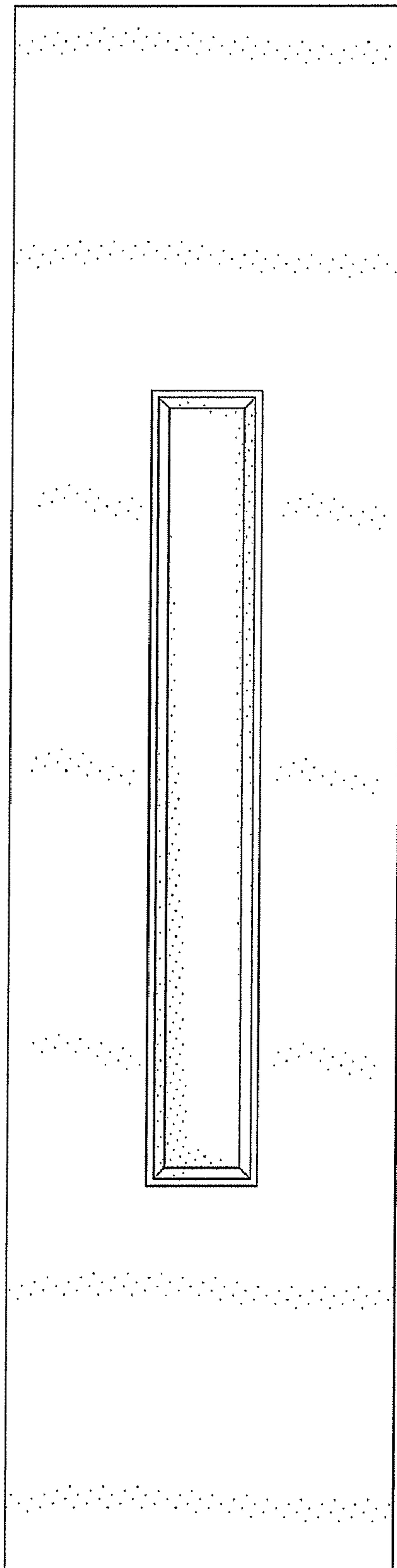

FIG. 5

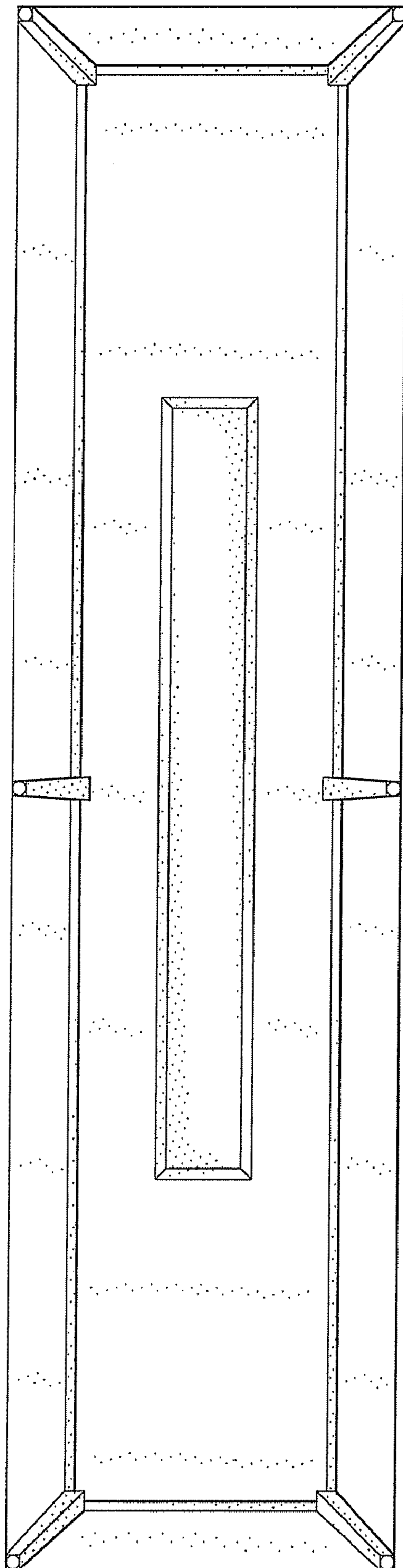

FIG. 6