



US00D659413S

(12) **United States Design Patent**
Arko et al.

(10) **Patent No.:** **US D659,413 S**
(45) **Date of Patent:** **** May 15, 2012**

(54) **SEAT**
(75) Inventors: **Robert Peter Arko**, San Francisco, CA (US); **John R. Hamilton**, Grand Rapids, MI (US); **Matthew Hollingsworth**, San Francisco, CA (US)

(73) Assignee: **Steelcase Inc.**, Grand Rapids, MI (US)

(**) Term: **14 Years**

(21) Appl. No.: **29/390,350**

(22) Filed: **Apr. 22, 2011**

(51) **LOC (9) Cl.** **06-01**

(52) **U.S. Cl.** **D6/334**

(58) **Field of Classification Search** D6/334, D6/335, 337, 374, 379, 380, 381, 491, 492, D6/495, 500-502, 341; 297/118, 300.1, 297/302.1, 311, 313, 353, 354.1, 445.1, 446.1, 297/446.2, 447.4, 464, 465, 900, DIG. 2, 297/DIG. 7; 5/12.1, 12.2
See application file for complete search history.

(56) **References Cited**

U.S. PATENT DOCUMENTS

2,217,426	A *	10/1940	Zareko	297/117
D169,911	S	6/1953	Netzer		
D170,088	S	7/1953	Hoffman		
D170,122	S	8/1953	Jorgensen		
D175,877	S	10/1955	Bartolucci		
D179,829	S	3/1957	Wilson		
2,793,685	A *	5/1957	Spitz	297/411.27
D186,308	S	10/1959	Knoll		
2,965,160	A	12/1960	Knoll		
2,979,122	A	4/1961	Knoll		
2,985,892	A	5/1961	Garrigus, Sr. et al.		
2,997,724	A	8/1961	Heumann		
3,328,810	A	7/1967	Berman		
3,380,777	A	4/1968	Bennett		
3,695,690	A *	10/1972	Carson	297/218.3

3,857,120	A *	12/1974	Acker	5/12.1
D234,331	S *	2/1975	Rocchis	D6/369
D244,069	S *	4/1977	Summer	D6/371
4,188,066	A *	2/1980	Terenzoni	297/440.23
D272,968	S	3/1984	Fairaizen		
4,621,381	A	11/1986	Schramek		
D329,543	S *	9/1992	Shields	D6/334
D360,310	S	7/1995	Stamberg et al.		
D373,257	S *	9/1996	Hutton	D6/381
D379,269	S *	5/1997	Hutton	D6/334
D384,827	S	10/1997	Hutton		
D385,122	S	10/1997	Hutton		
D410,800	S *	6/1999	Gomez	D6/369
D422,422	S *	4/2000	Black	D6/369
D429,082	S	8/2000	Desombre		

(Continued)

OTHER PUBLICATIONS

Metropolitan Furniture Corporation. "Contract Bench". Interiors catalog. Copyright Apr. 1961.

(Continued)

Primary Examiner — Sandra Snapp

(74) *Attorney, Agent, or Firm* — Quarles & Brady LLP

(57) **CLAIM**

The ornamental design for a seat, as shown and described.

DESCRIPTION

FIG. 1 is a left, top, front perspective view of a seat according to our new design, the bottom thereof is unseen in use; FIG. 2 is a top, rear perspective view from the right side thereof; FIG. 3 is a front elevational view thereof; FIG. 4 is a rear elevational view thereof; FIG. 5 is a right side elevational view thereof, the left side elevational view thereof being a mirror image of the right side shown; and, FIG. 6 is a top plan view thereof.

1 Claim, 3 Drawing Sheets

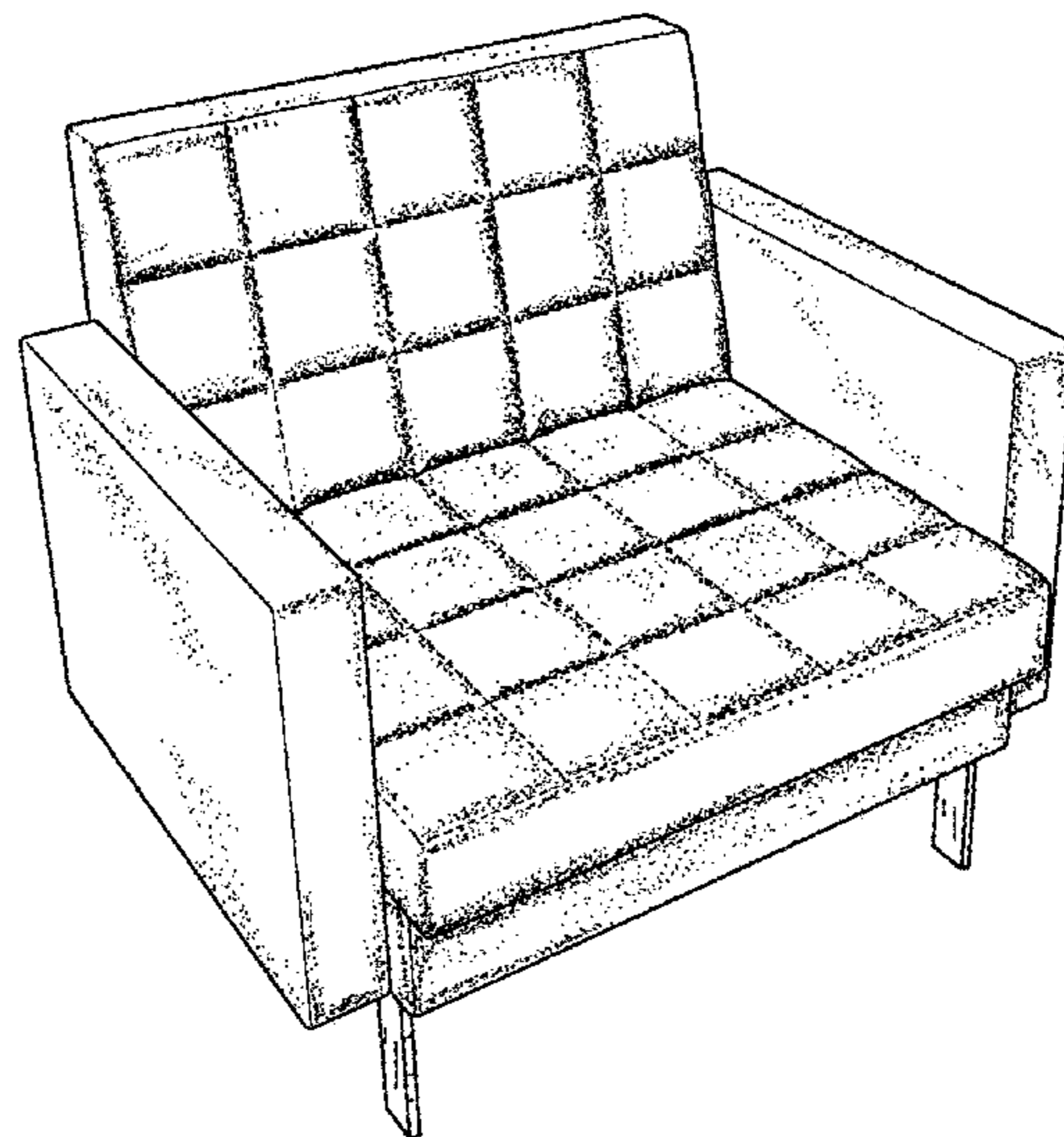

U.S. PATENT DOCUMENTS

D433,824	S	11/2000	King	
D443,989	S	6/2001	Gomez	
D444,305	S	7/2001	Mourgue	
D455,281	S	4/2002	Andersen et al.	
D455,282	S	4/2002	Andersen et al.	
D473,723	S	4/2003	Pesso	
D477,152	S	7/2003	Levy	
D484,327	S	12/2003	Ricci	
D485,086	S	1/2004	Gomez	
D486,311	S	* 2/2004	Boydak	D6/335
D486,652	S	* 2/2004	Nemeth	D6/334
D489,188	S	5/2004	Ricci	
D490,630	S	6/2004	Pesso	
D495,153	S	8/2004	Ricci	
D495,514	S	9/2004	Ricci	
D495,892	S	* 9/2004	Ricci	D6/381
D495,893	S	9/2004	Ricci	
D498,064	S	11/2004	Gomez	
D498,075	S	11/2004	Mourgue	
D498,941	S	11/2004	Ricci	
6,824,220	B1	* 11/2004	Davison	297/440.14
D499,261	S	12/2004	Ricci	
D501,330	S	2/2005	Gomez	
D505,276	S	5/2005	Cronk et al.	
D511,415	S	11/2005	Pesso	
D515,334	S	2/2006	Natuzzi	
D518,654	S	4/2006	Pesso	
D527,541	S	9/2006	Natuzzi	
D533,365	S	* 12/2006	Martin	D6/334
D538,054	S	3/2007	Lissoni	
D539,561	S	4/2007	Martin	
D542,560	S	5/2007	Ricci	
D545,070	S	6/2007	Hutton	
D549,470	S	8/2007	Hutton	
D552,864	S	* 10/2007	Natuzzi	D6/381
D552,867	S	* 10/2007	Natuzzi	D6/381
D569,111	S	5/2008	Swanson	
D569,112	S	5/2008	Swanson	
D569,113	S	5/2008	Lewis	
D571,574	S	* 6/2008	Natuzzi	D6/381
D572,916	S	7/2008	Galardo et al.	
D573,358	S	7/2008	Gharabegian	
D577,211	S	9/2008	Natuzzi	
D577,222	S	9/2008	Natuzzi	
D577,506	S	9/2008	Natuzzi	
D580,670	S	11/2008	Weiss	
D583,585	S	* 12/2008	Weiss	D6/381
D586,131	S	2/2009	Cramer et al.	
D586,156	S	2/2009	Schweikarth et al.	
D590,171	S	4/2009	Natuzzi	
D590,623	S	4/2009	Natuzzi	
D591,970	S	5/2009	Weiss	
D592,416	S	5/2009	Weiss	
D600,037	S	9/2009	Natuzzi	
D601,825	S	10/2009	Starck	
D603,617	S	* 11/2009	Weiss	D6/381
D603,618	S	11/2009	Weiss	
D603,619	S	11/2009	Weiss	

D604,957	S	12/2009	Weiss	
D607,227	S	1/2010	Massaud	
D613,960	S	* 4/2010	Griepentrog et al.	D6/381
D614,419	S	4/2010	Andersen	
D614,884	S	5/2010	Metcalf et al.	
D615,315	S	5/2010	Andersen	
D615,766	S	5/2010	Andersen	
D615,767	S	* 5/2010	Griepentrog et al.	D6/381
D618,007	S	6/2010	Andersen	
D623,869	S	9/2010	Andersen	
D628,403	S	12/2010	Starck	
D630,029	S	1/2011	Delbridge	
D650,605	S	* 12/2011	Haimoff et al.	D6/369
2002/0000741	A1	* 1/2002	Clay et al.	297/118

OTHER PUBLICATIONS

Metropolitan Furniture Corporation. "Contract B". Interiors catalog. Copyright Apr. 1961.

Metropolitan Furniture Corporation. "Contract C". Interior Design catalog. Copyright Aug. 1962.

Metropolitan Furniture Corporation. "506JVision". Palto alto Times, Copyright Nov. 19, 1957.

NLBAA Sofa, First Proof Journal Oregon Journal of CA 2-5511, Sunday, Oct. 11. No. 6226 Journal.

NLBAA Sofa, Sunset Magazine, Mar. 1961.

Metropolitan Furniture Company. "Sofa". Retailing Daily, Aug. 19, 1954, p. 10.

Metropolitan Furniture Company. "Chairs". Pennisula Living, Sep. 14-15, 1957, p. 25.

Metropolitan Furniture Company. "Sofa". Nat'l Furniture Review Aug. 15, 1961.

Metropolitan Furniture Company. Pierce Sofa, Nat'l Furniture Review, Aug. 15, 1961.

Metropolitan Furniture Company. Elegance/NLBAA Contract B Series, Contract Magazine, Feb. 1961.

Metropolitan Furniture Company. "Contract H". Metropolitan Furniture Sales Brochure 1961.

Metropolitan Furniture Company. "Contract B sofa, table and chair" National Furniture Review, Apr. 20, 1962.

Metropolitan Furniture Company. "Myriad collection", Printed publication published on or around Jun. 1961.

Metropolitan Furniture Company. "Contract B Table". Metropolitan Brochure.

Advertisement from Sloane's (San Francisco). San Francisciana.

Metropolitan Furniture Company. Advertisement/Brochure.

Metropolitan Furniture Company. "Elegance at a Price". In-house Metropolitan ad/brochure.

Metropolitan Furniture Company. "Sofa". Advertisement.

Sloane's (San Francisco) Sofas and Chairs. Advertisement.

Metropolitan Furniture Company. "Metropolitan's high-back chair".

Metropolitan Furniture Company. "Sofa". Fraser's /Berkeley Telegraph and Channing advertisement.

Metropolitan Furniture Company. "The Weekender Sofa/Bed". Furniture Forum catalog, section 1, p. 32.

* cited by examiner

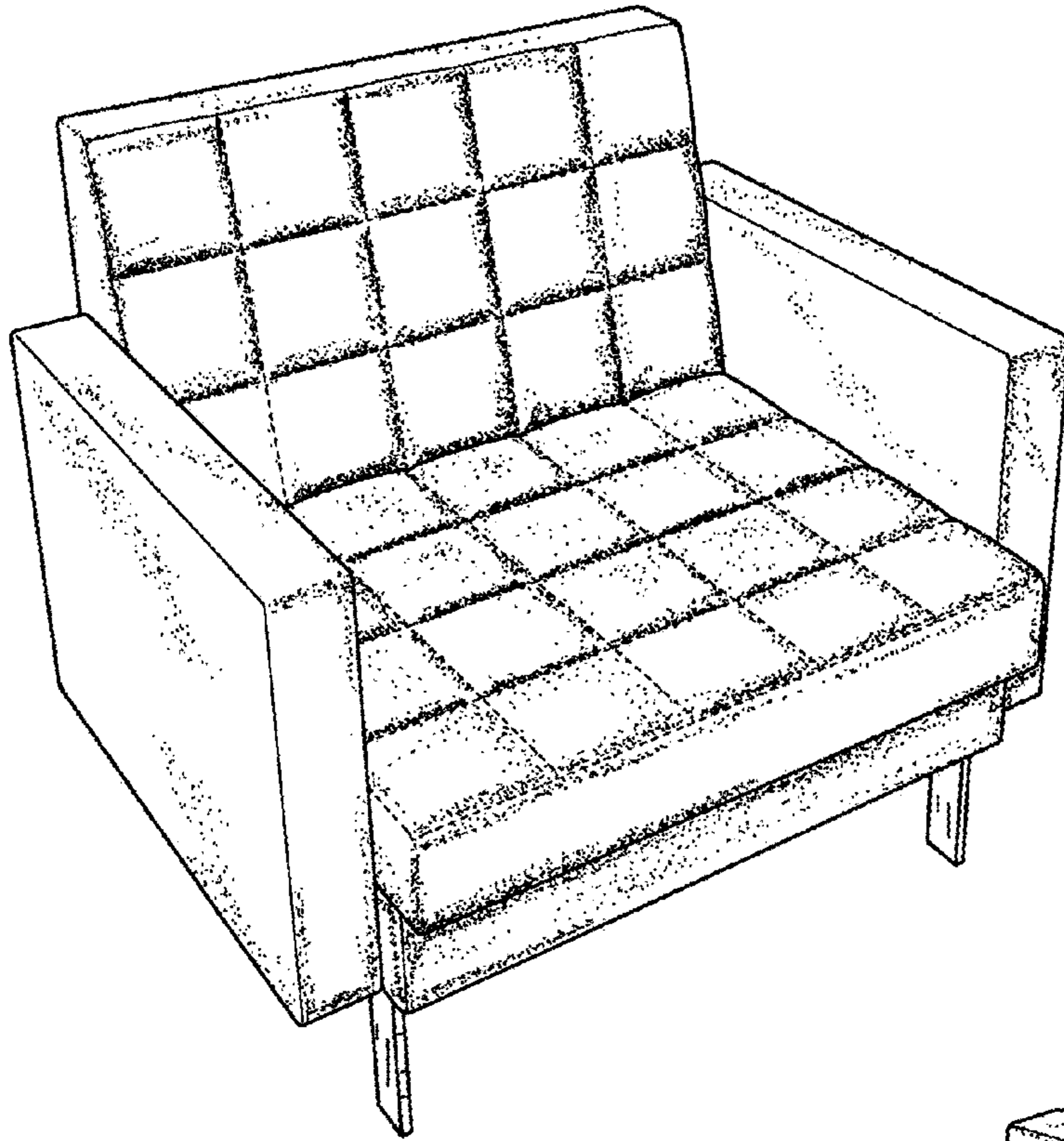

FIG. 1

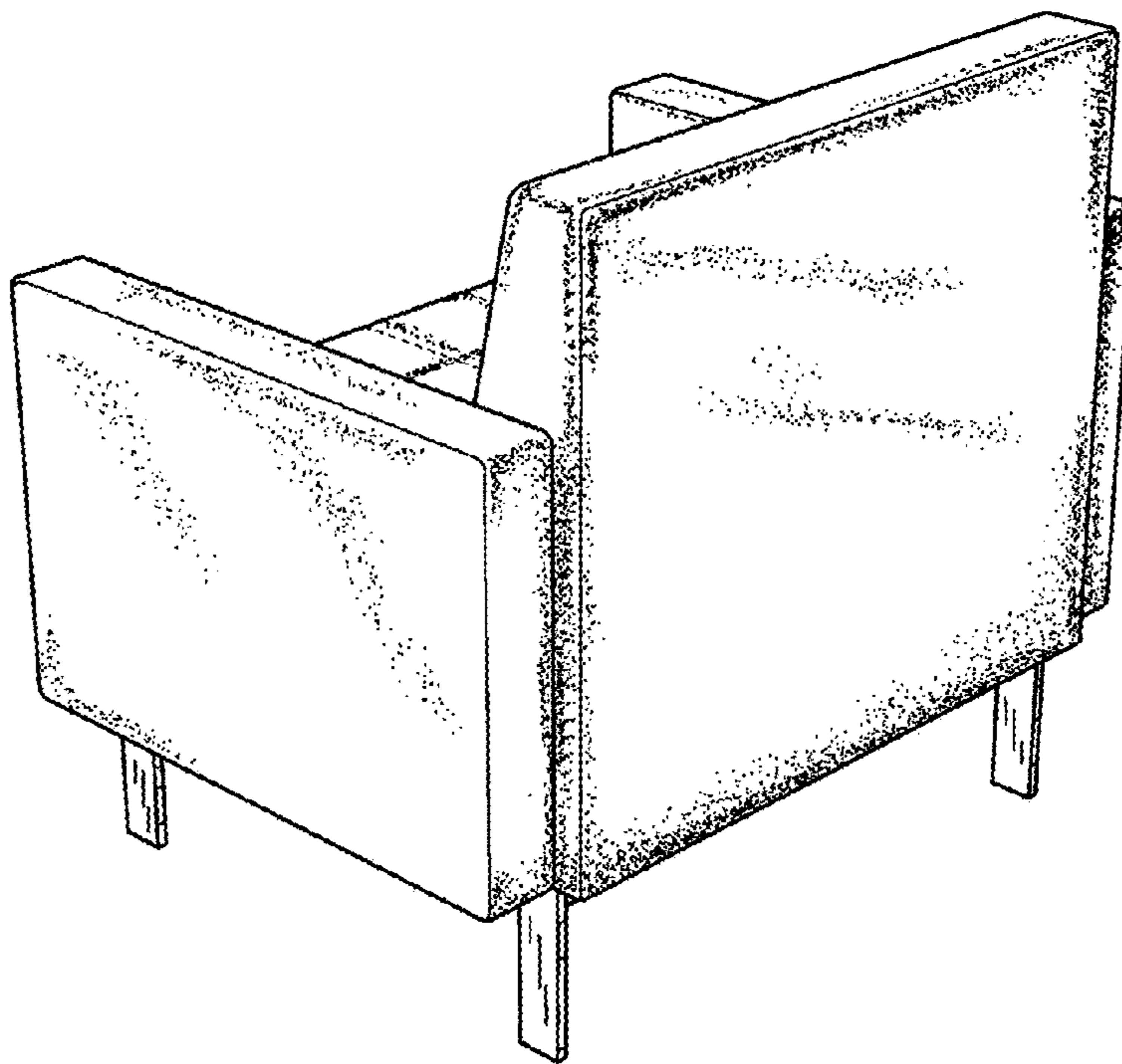

FIG. 2

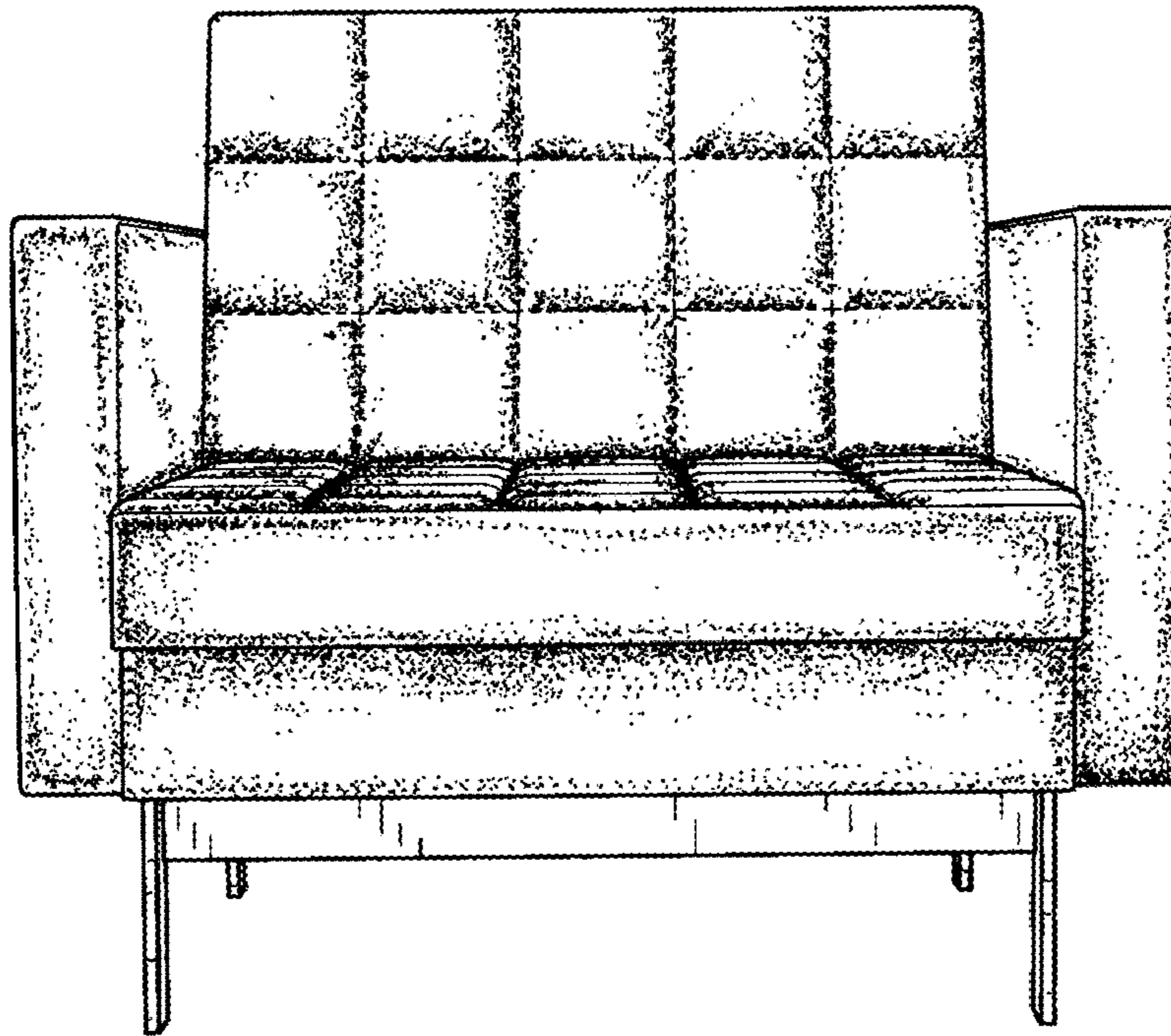

FIG. 3

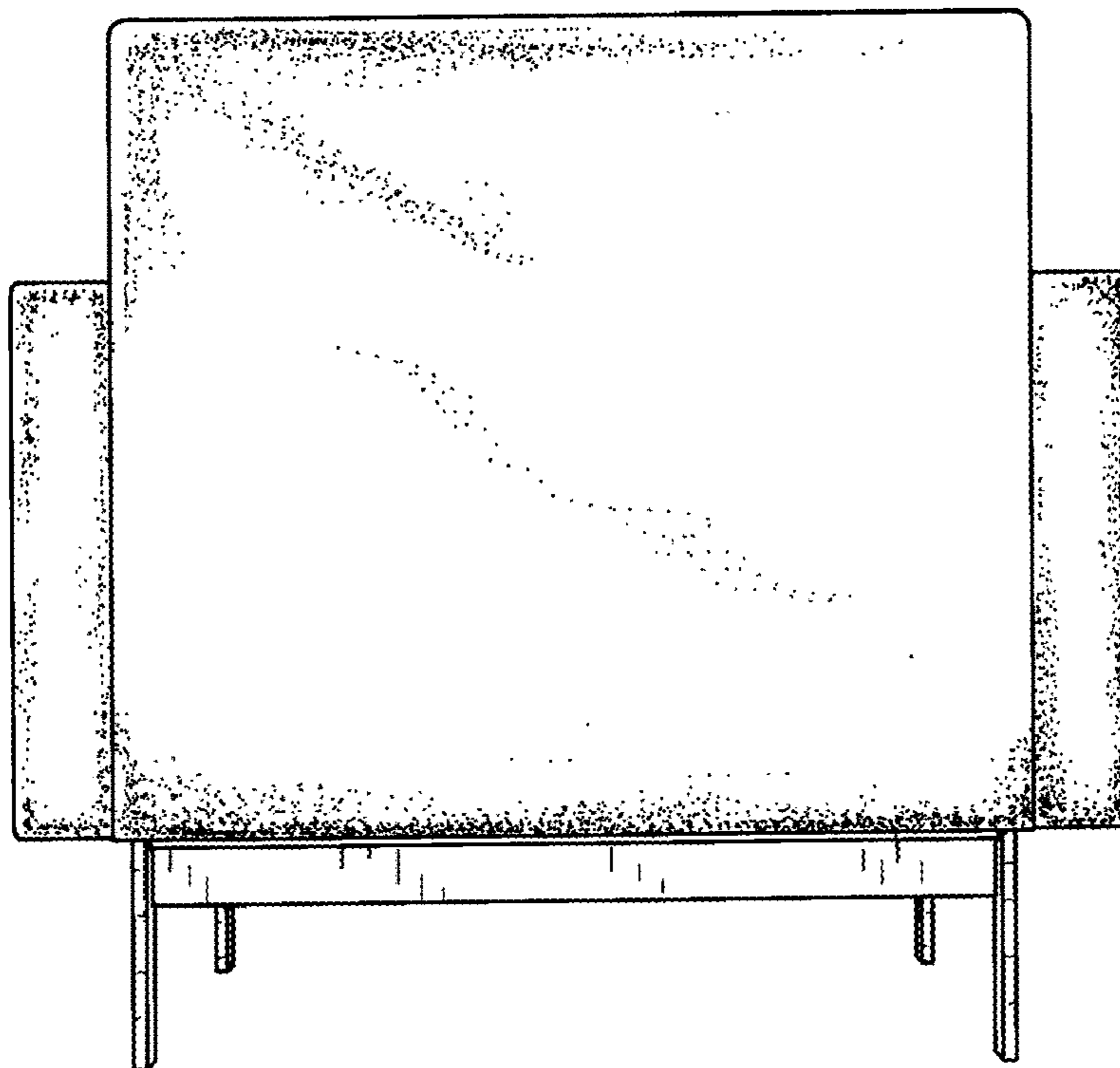

FIG. 4

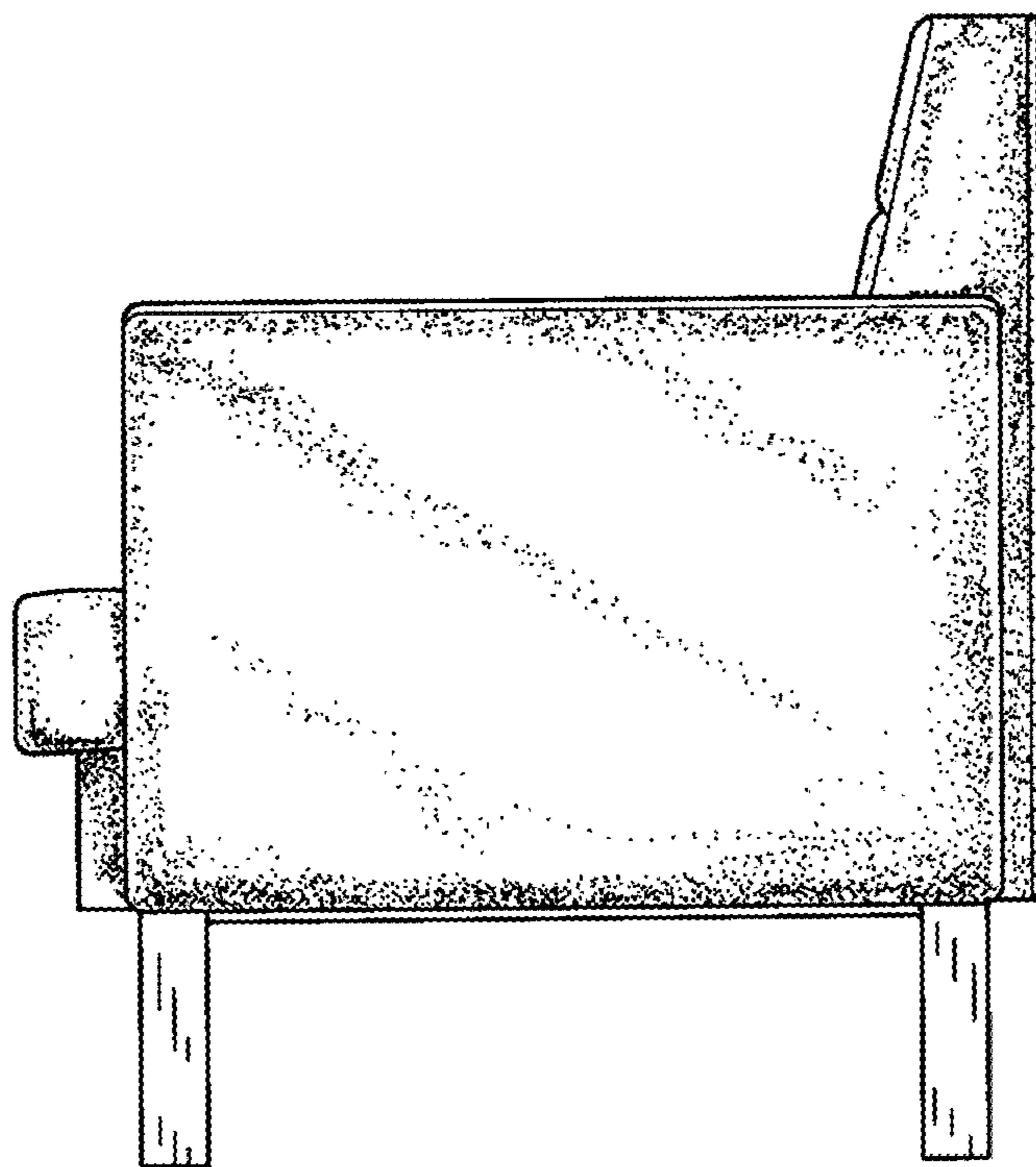

FIG. 5

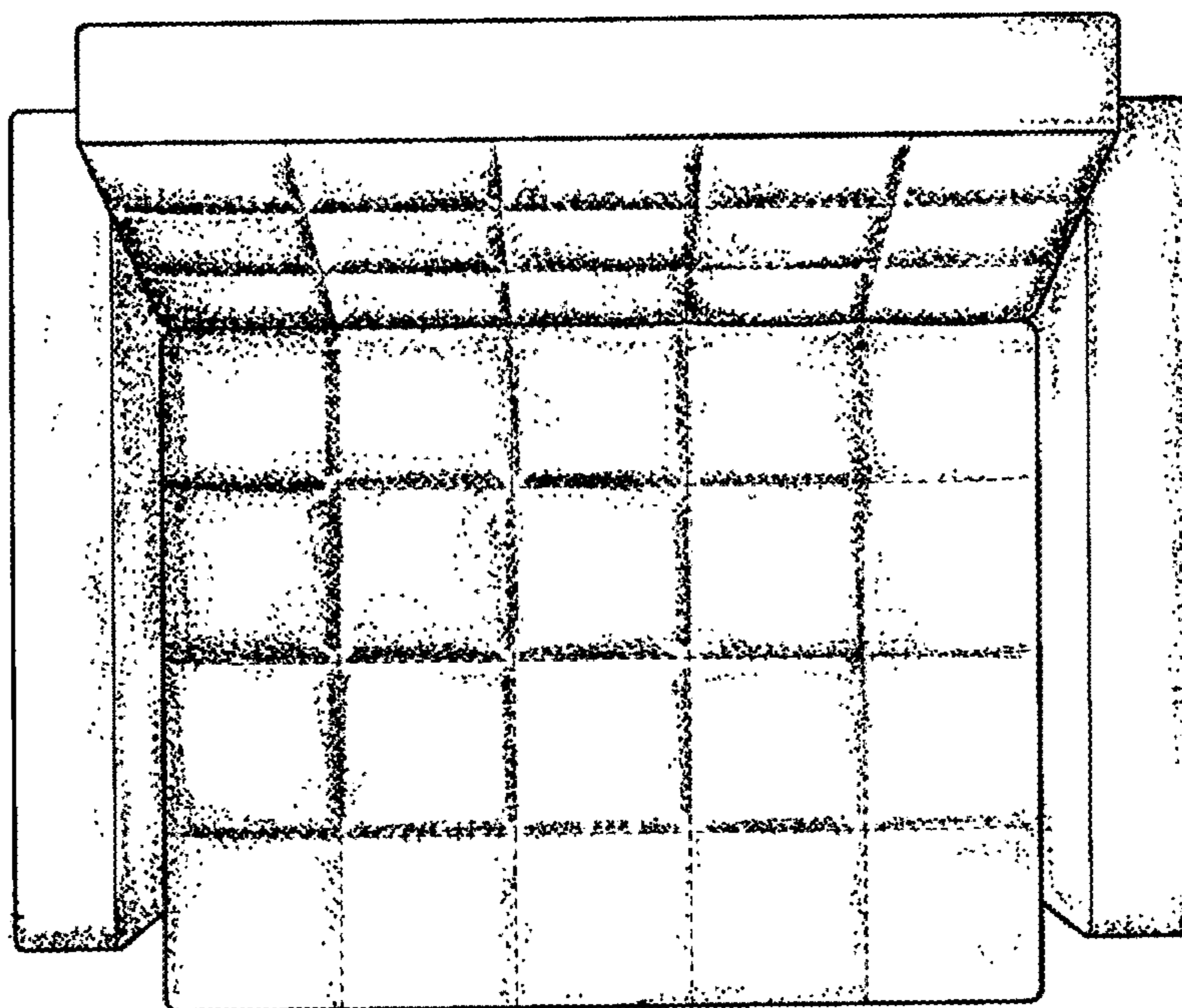

FIG. 6