



US00D659410S

(12) **United States Design Patent**  
**Chiu**

(10) **Patent No.:** **US D659,410 S**

(45) **Date of Patent:** **\*\* May 15, 2012**

(54) **DISPLAY**

(75) Inventor: **Yi-Chung Chiu**, Taoyuan (TW)

(73) Assignee: **Hannspree, Inc.**, New Taipei (TW)

(\*\*) Term: **14 Years**

(21) Appl. No.: **29/389,253**

(22) Filed: **Apr. 8, 2011**

(51) **LOC (9) Cl.** ..... **06-04**

(52) **U.S. Cl.** ..... **D6/308; D14/371**

(58) **Field of Classification Search** ..... D6/300,  
D6/308, 304, 310, 303; D14/372, 448, 449,  
D14/450, 141.2, 126, 375, 371, 336, 168;  
24/103; D11/133, 140, 134; 40/700, 1.5,  
40/124.5, 714, 721, 768; D20/15; D3/257;  
D16/227

See application file for complete search history.

(56) **References Cited**

**U.S. PATENT DOCUMENTS**

D379,458 S \* 5/1997 Muller et al. .... D14/168  
D401,605 S \* 11/1998 Shirley ..... D16/227

D442,885 S \* 5/2001 Olinger ..... D11/133  
D501,729 S \* 2/2005 Fonfeder ..... D6/303  
D577,206 S \* 9/2008 Chang et al. .... D6/300  
D585,644 S \* 2/2009 Guilbault ..... D3/257  
D637,010 S \* 5/2011 Chen ..... D6/303

\* cited by examiner

*Primary Examiner* — Philip S Hyder

*Assistant Examiner* — Sydney Buffalow

(74) *Attorney, Agent, or Firm* — Bacon & Thomas, PLLC

(57) **CLAIM**

The ornamental design for a display, as shown.

**DESCRIPTION**

FIG. 1 is a perspective view of a display showing my new design;

FIG. 2 is a front elevational view thereof;

FIG. 3 is a rear elevational view thereof;

FIG. 4 is a left side elevational view thereof;

FIG. 5 is a right side elevational view thereof;

FIG. 6 is a top plan view thereof;

FIG. 7 is a bottom plan view thereof; and,

FIG. 8 is a rear perspective view thereof.

**1 Claim, 7 Drawing Sheets**

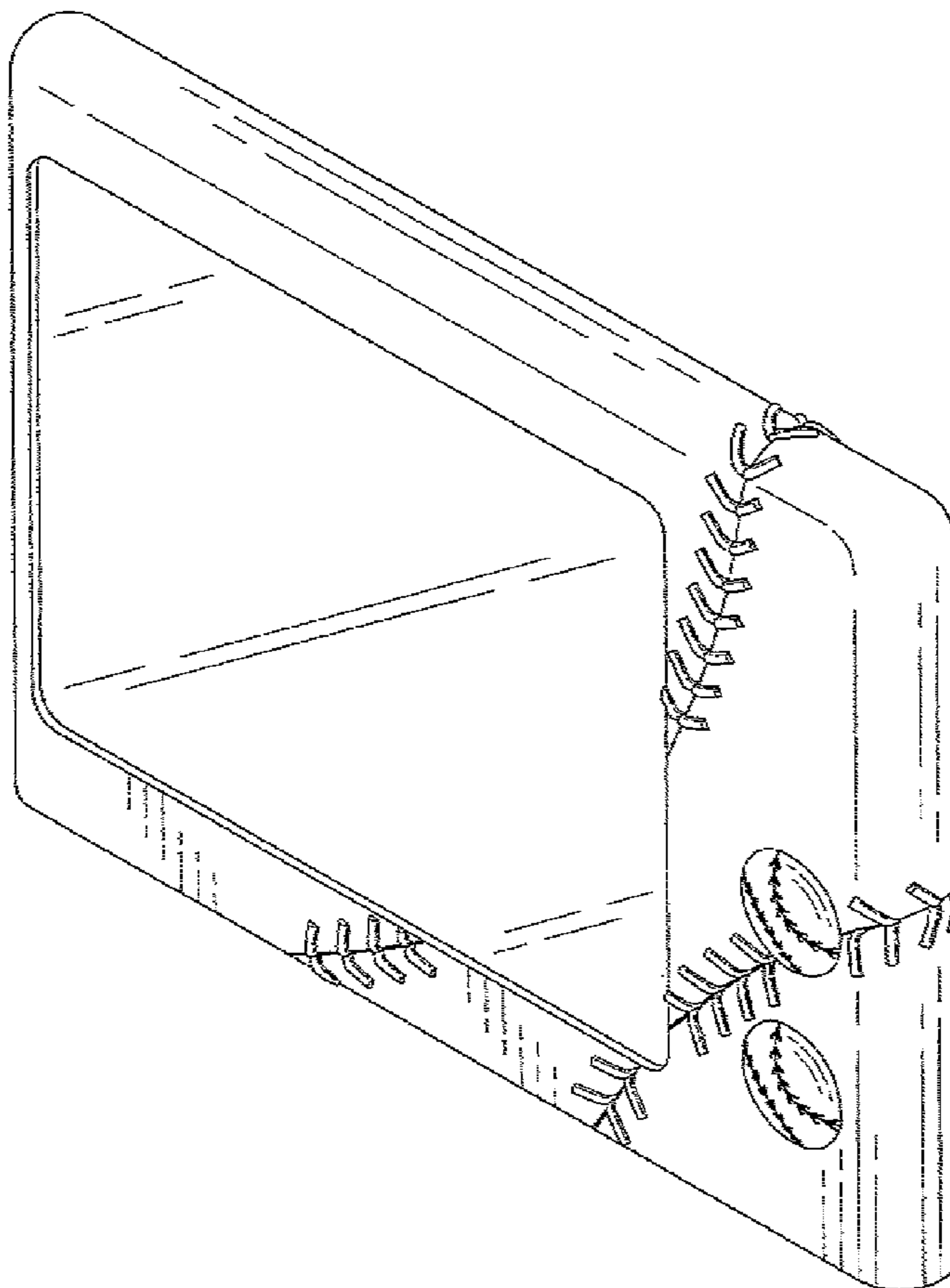

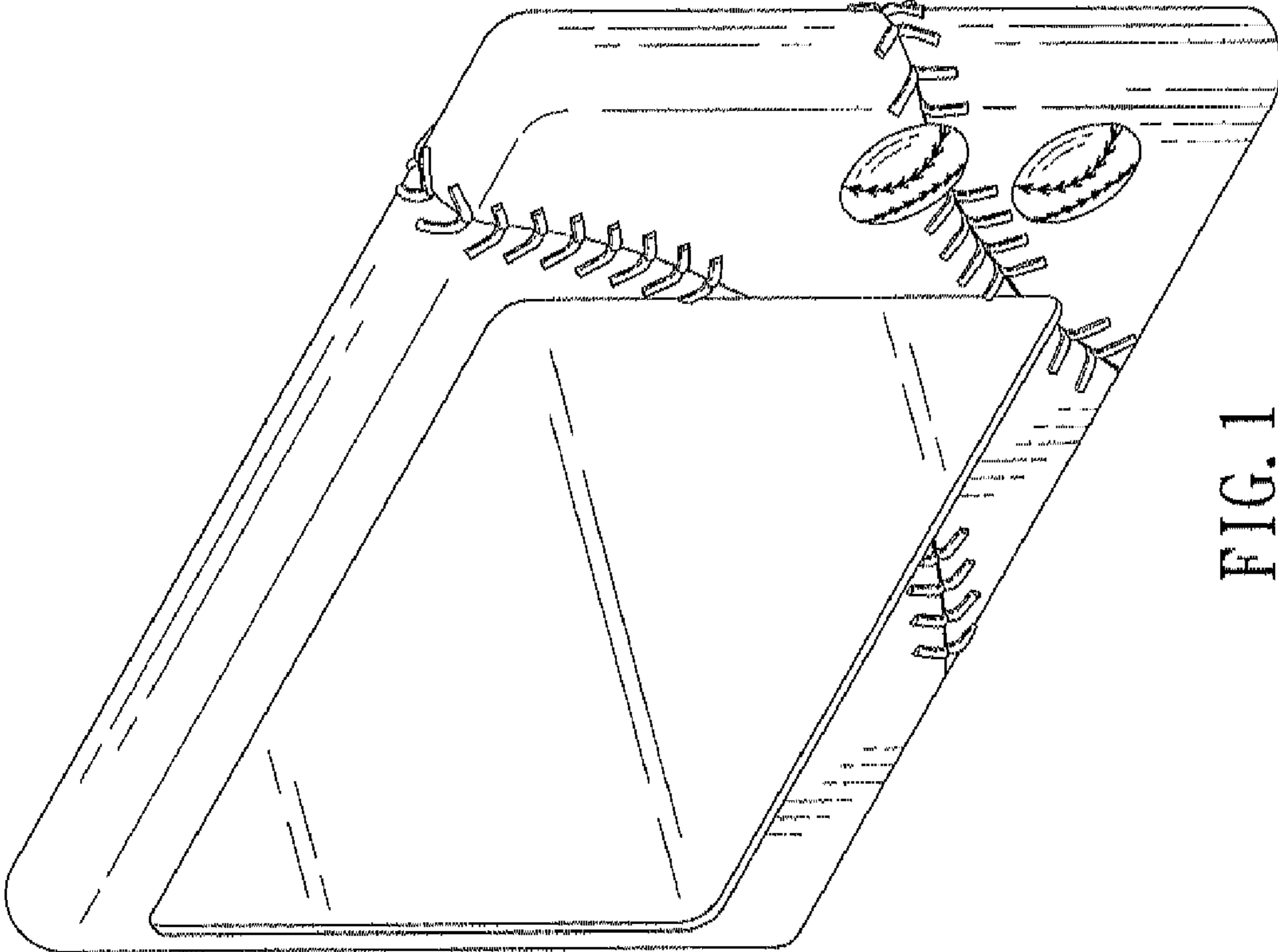

FIG. 1

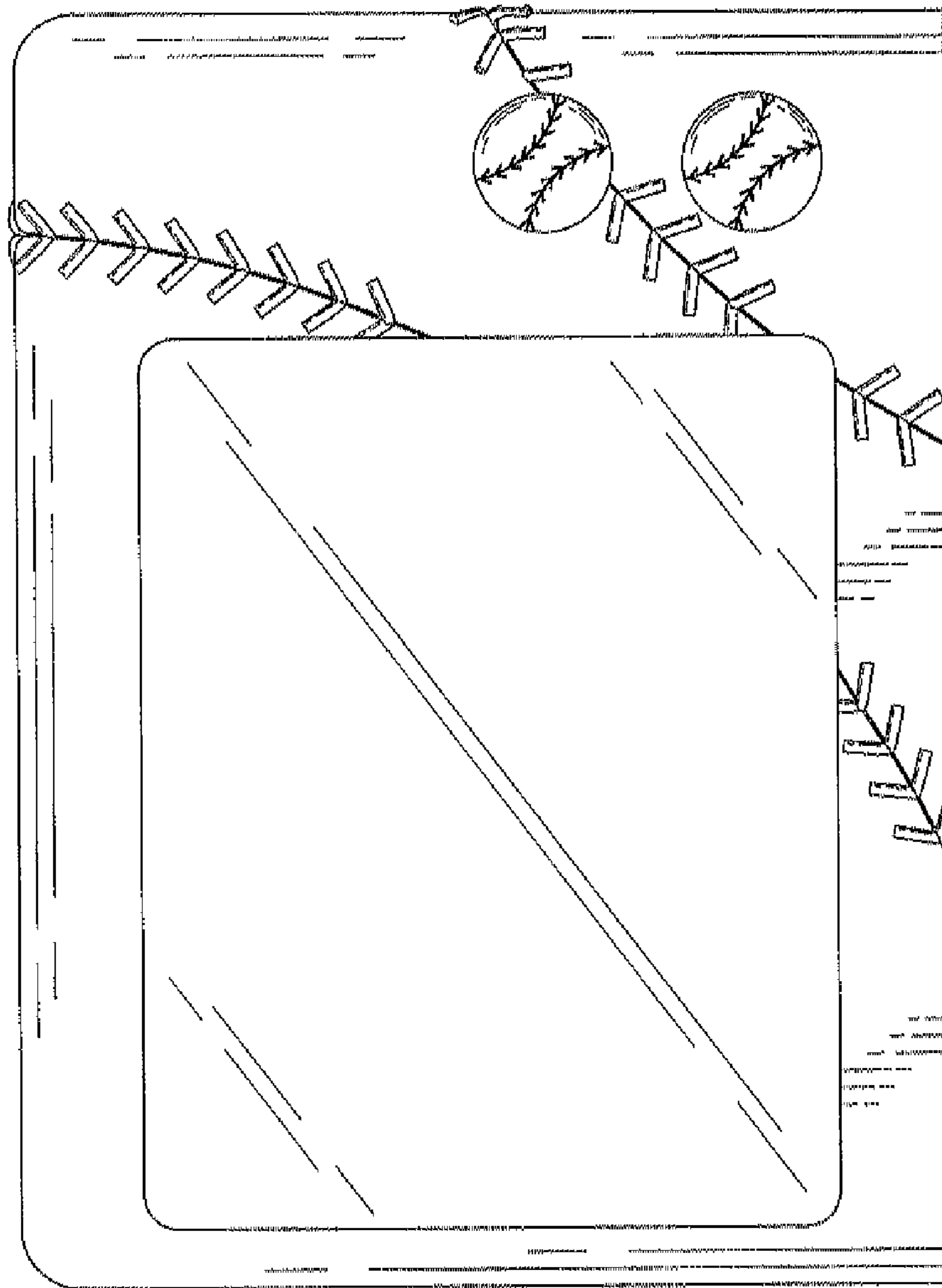

FIG. 2

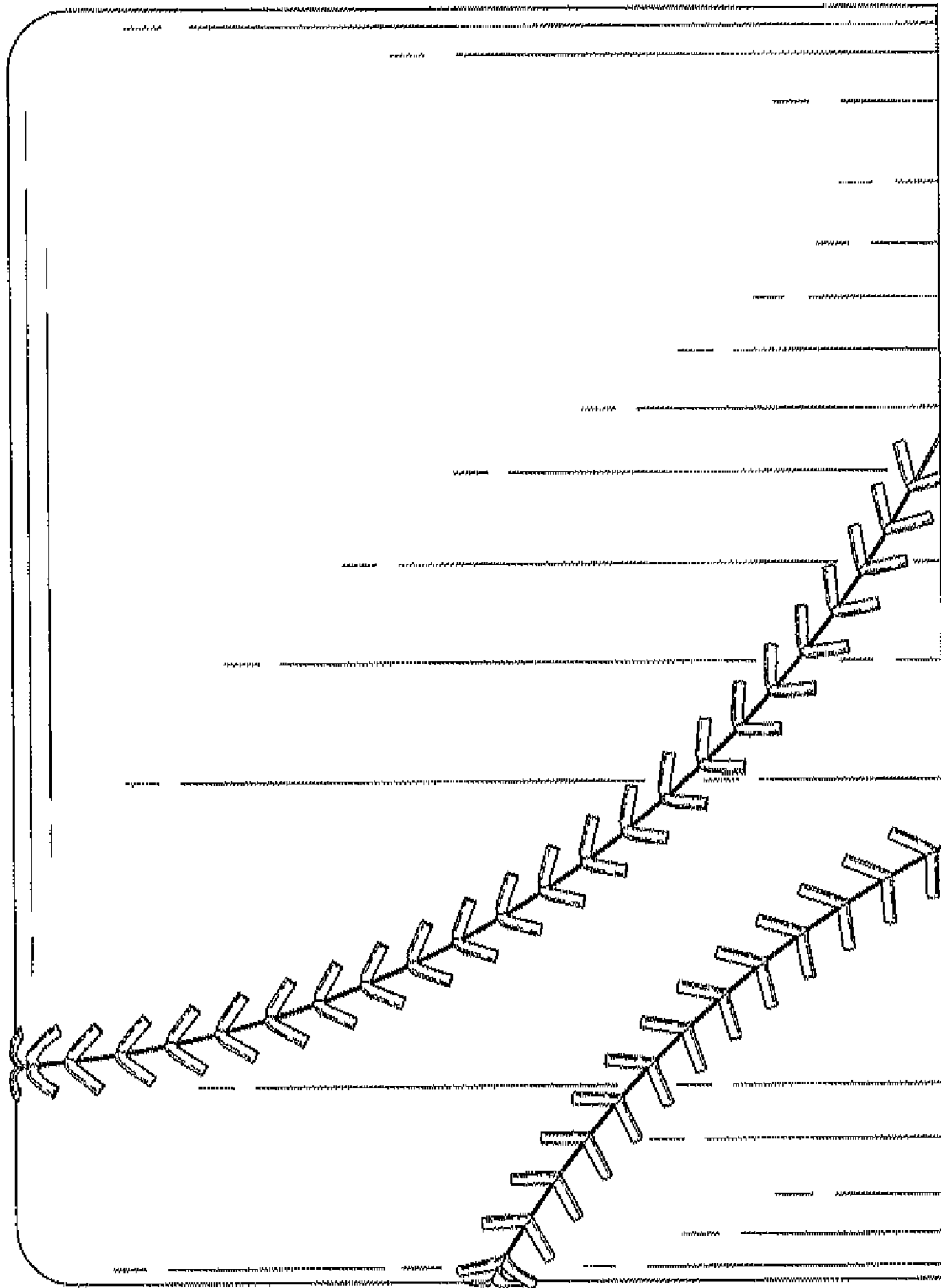

FIG. 3

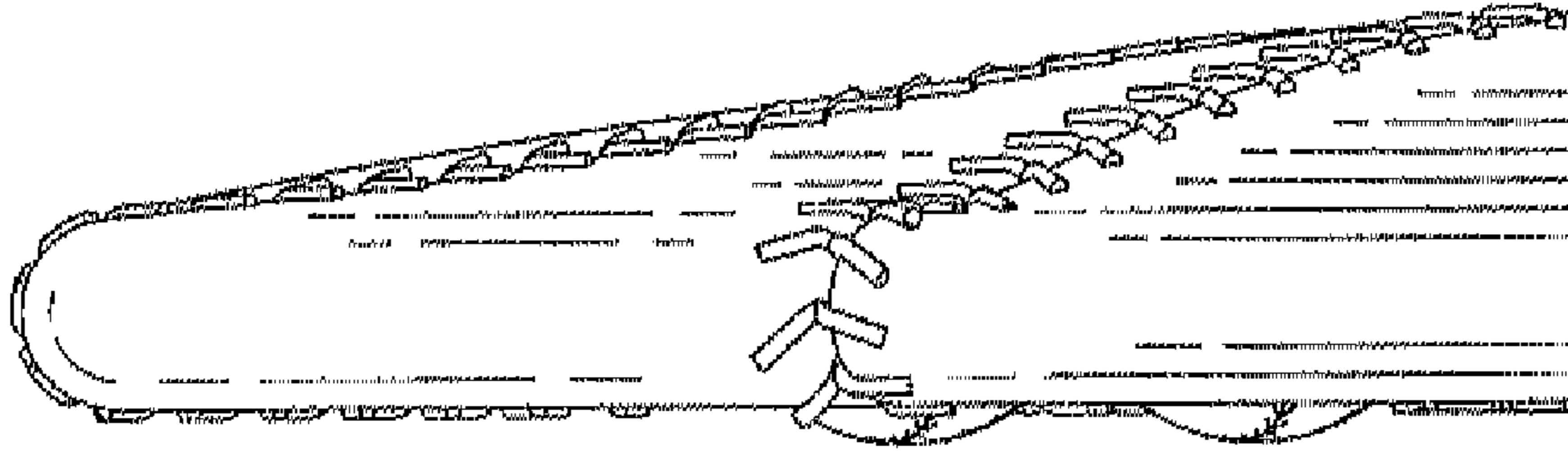

FIG. 5

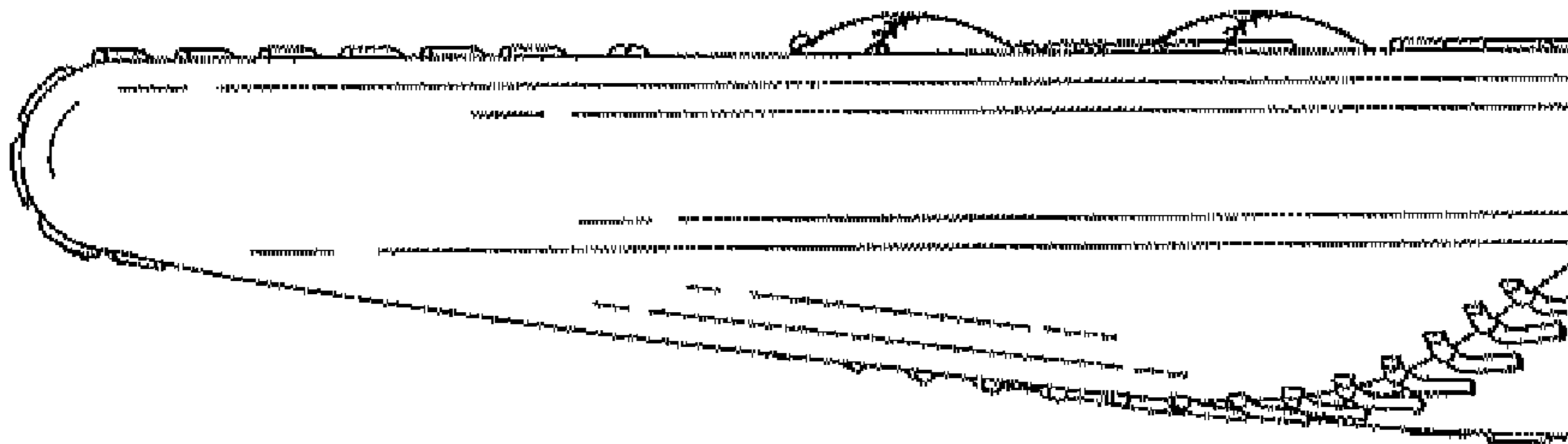

FIG. 4

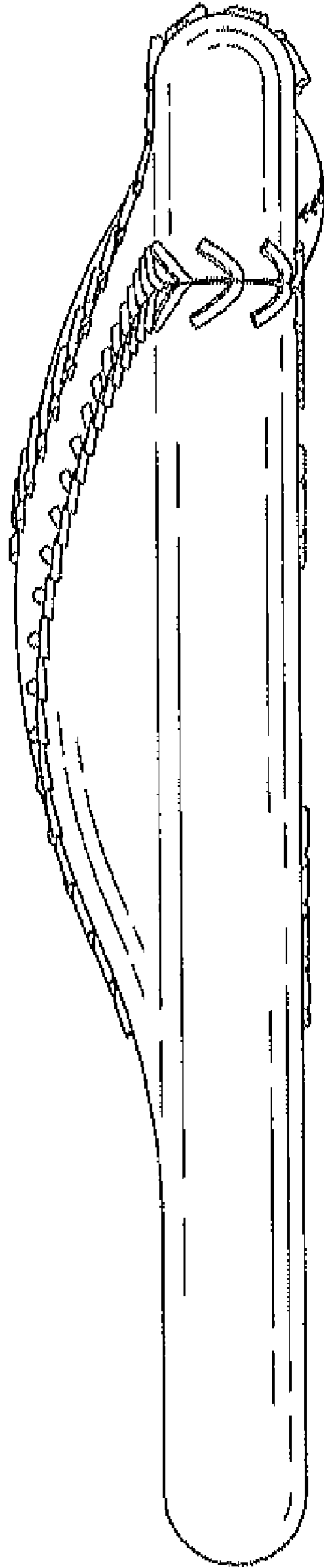

FIG. 6

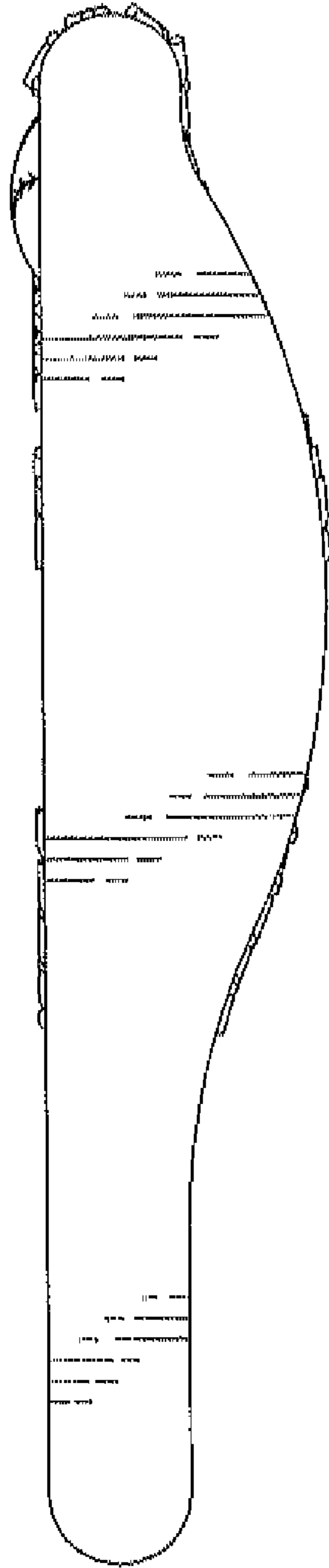

FIG. 7

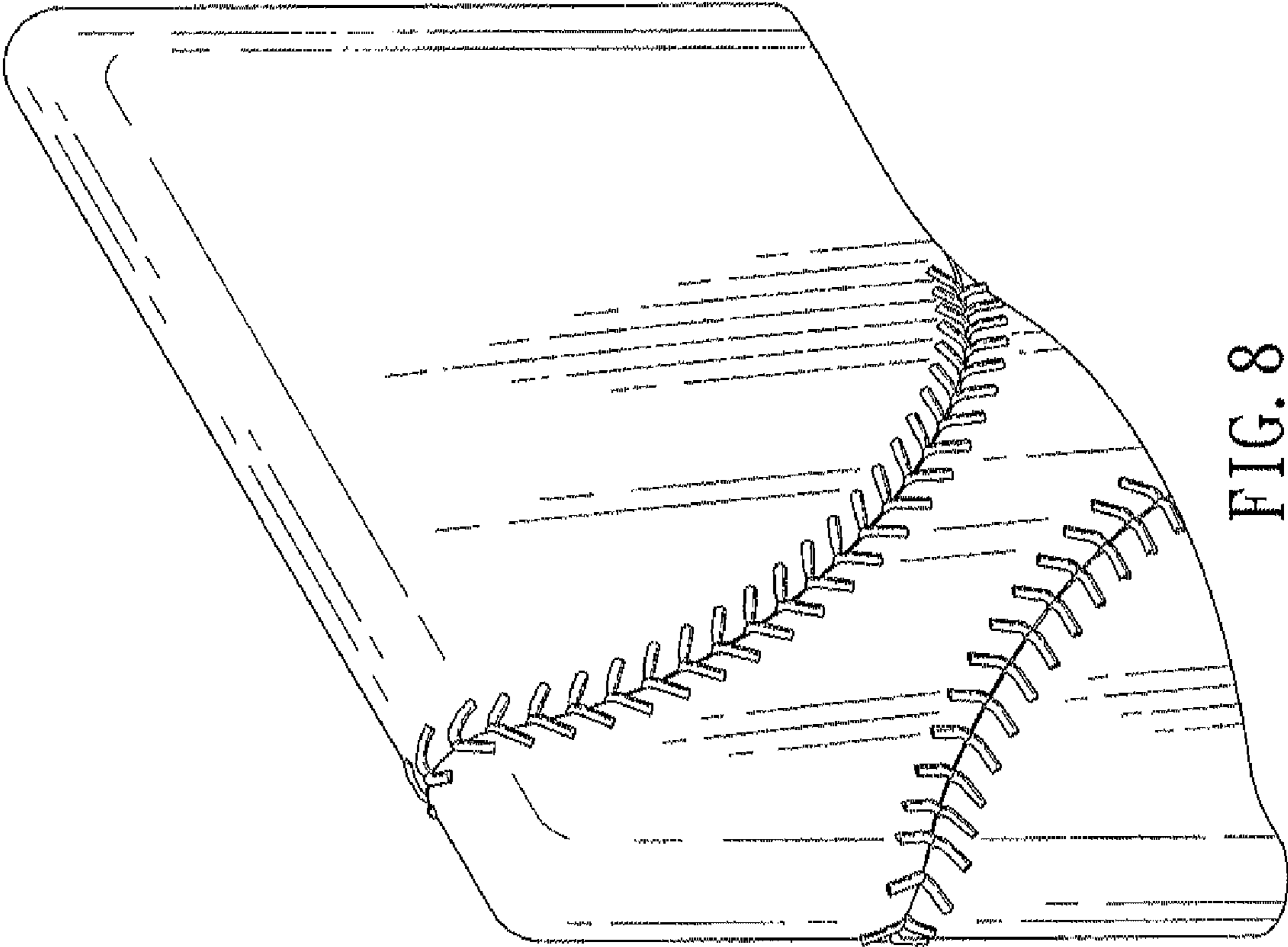

FIG. 8