



US00D659384S

(12) **United States Design Patent**
January

(10) **Patent No.:** **US D659,384 S**

(45) **Date of Patent:** **** May 15, 2012**

(54) **POUCH FOR HOLDING A RADIO**
(75) Inventor: **Michael W. January**, Spring Lake, NC
(US)

(73) Assignee: **Harris Corporation**, Melbourne, FL
(US)

(**) Term: **14 Years**

(21) Appl. No.: **29/404,173**

(22) Filed: **Oct. 17, 2011**

(51) **LOC (9) Cl.** **03-01**

(52) **U.S. Cl.** **D3/218**

(58) **Field of Classification Search** D3/218,
D3/219, 215, 201, 226, 269, 272-273, 303;
206/305, 320; D14/138, 156, 250, 251, 253;
379/428, 446, 455; 224/240-241, 245, 268-271,
224/197, 930, 904, 682-683, 250, 260, 908-909,
224/259

See application file for complete search history.

(56) **References Cited**

U.S. PATENT DOCUMENTS

D302,075 S * 7/1989 Burger D3/218
D318,569 S * 7/1991 Schaefer D3/218
D362,542 S * 9/1995 Richards et al. D3/218
D364,270 S * 11/1995 Kellerman D3/218

5,535,928 A * 7/1996 Herring 224/250
5,941,434 A * 8/1999 Green 224/250
D467,069 S * 12/2002 TenHoeve D3/218
D526,479 S * 8/2006 Brandenburg D3/218
D600,007 S * 9/2009 Levis et al. D3/218
7,810,683 B2 * 10/2010 Chan 224/222

* cited by examiner

Primary Examiner — Catheri Oliver

(74) *Attorney, Agent, or Firm* — Allen, Dyer, Doppelt,
Milbrath & Gilchrist, P.A.

(57) **CLAIM**

The ornamental design for a pouch for holding a radio, as shown and described.

DESCRIPTION

FIG. 1 is a perspective view of a pouch for holding a radio in accordance with the present invention.

FIG. 2 is a front view of the pouch of FIG. 1.

FIG. 3 is a right side view of the pouch of FIG. 1.

FIG. 4 is a rear view of the pouch of FIG. 1.

FIG. 5 is a left side view of the pouch of FIG. 1.

FIG. 6 is a top view of the pouch of FIG. 1; and,

FIG. 7 is a bottom view of the pouch of FIG. 1.

Those elements shown in dashed lines are included for the purpose of illustrating environment and form no part of the claimed design.

1 Claim, 6 Drawing Sheets

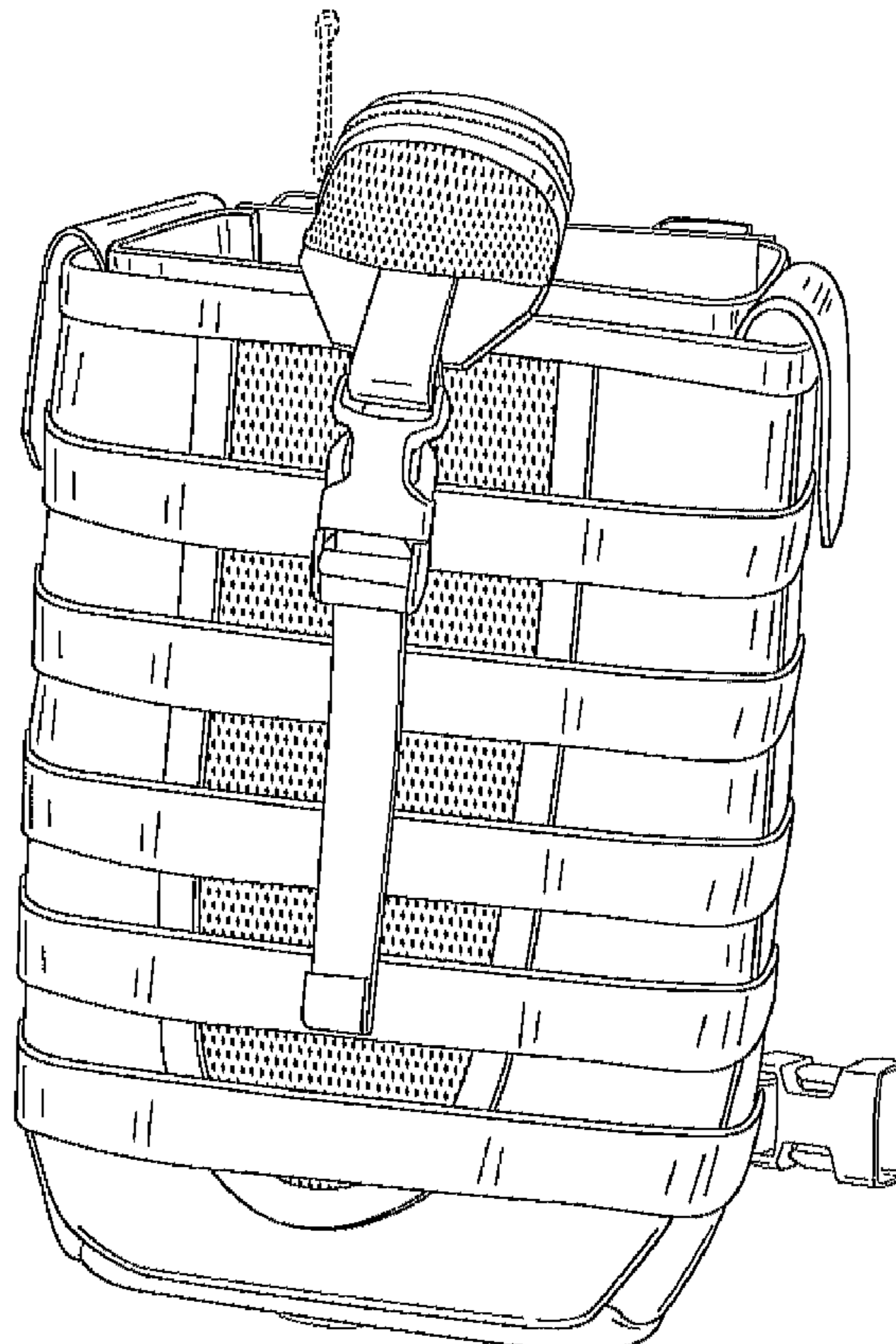

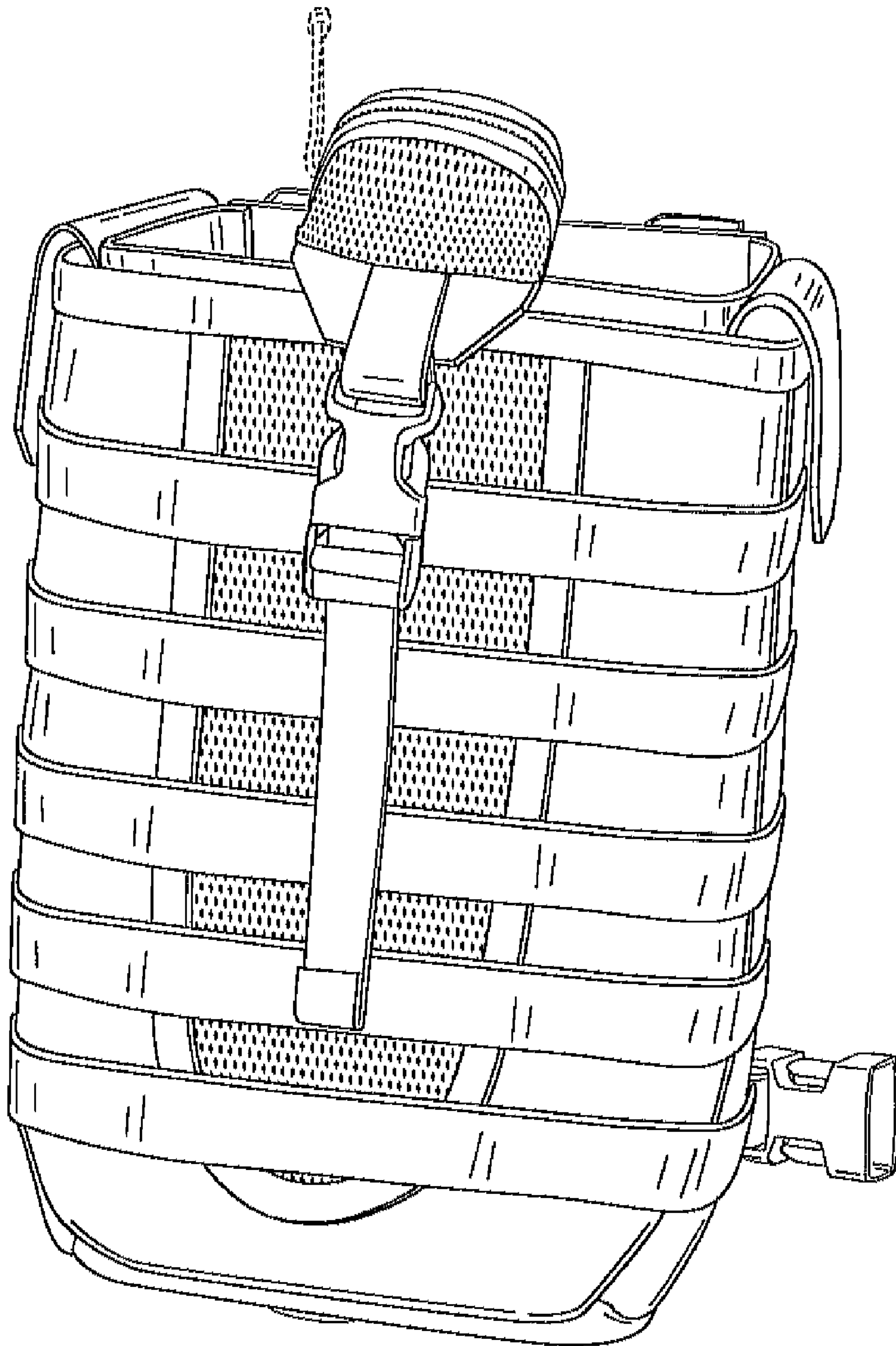

FIG. 1

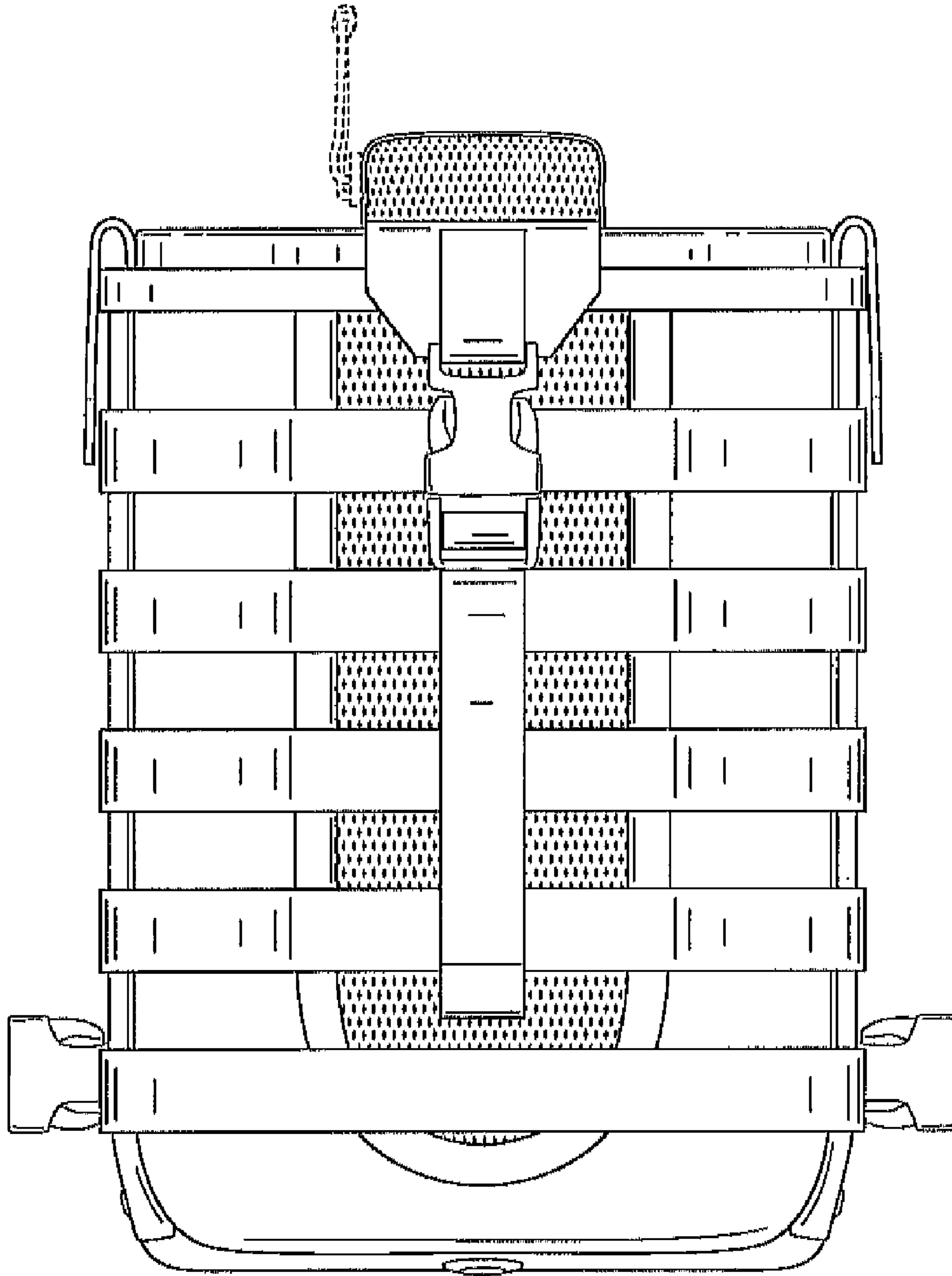

FIG. 2

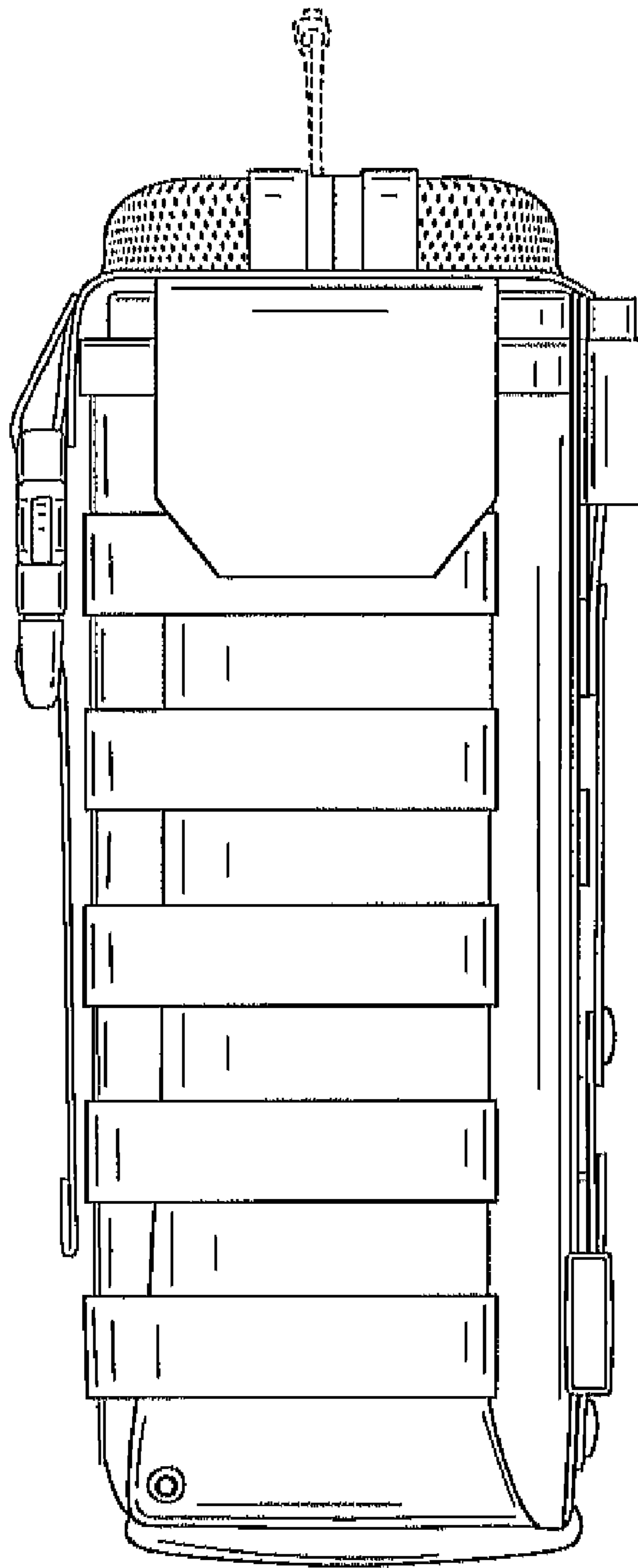

FIG. 3

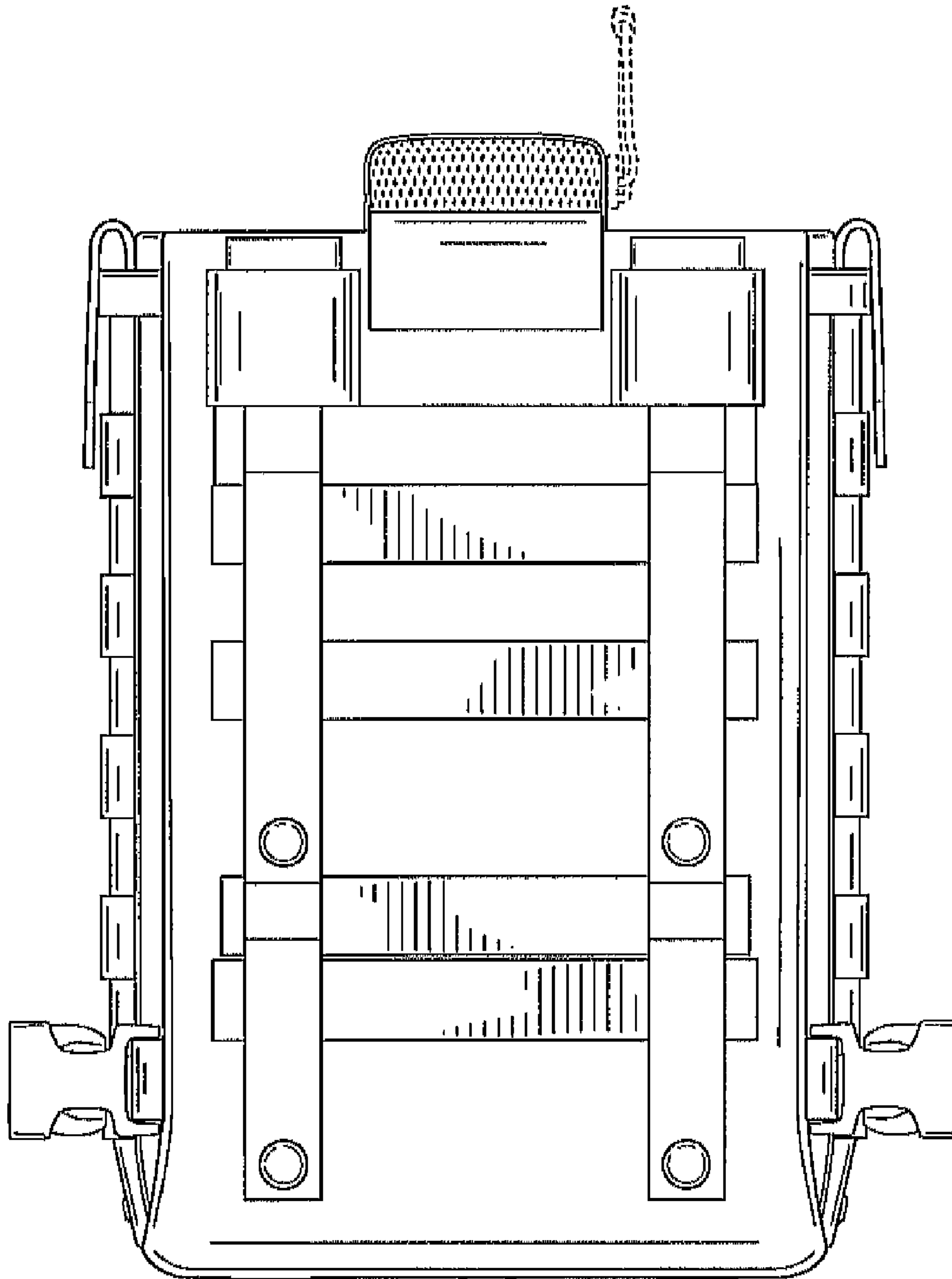

FIG. 4

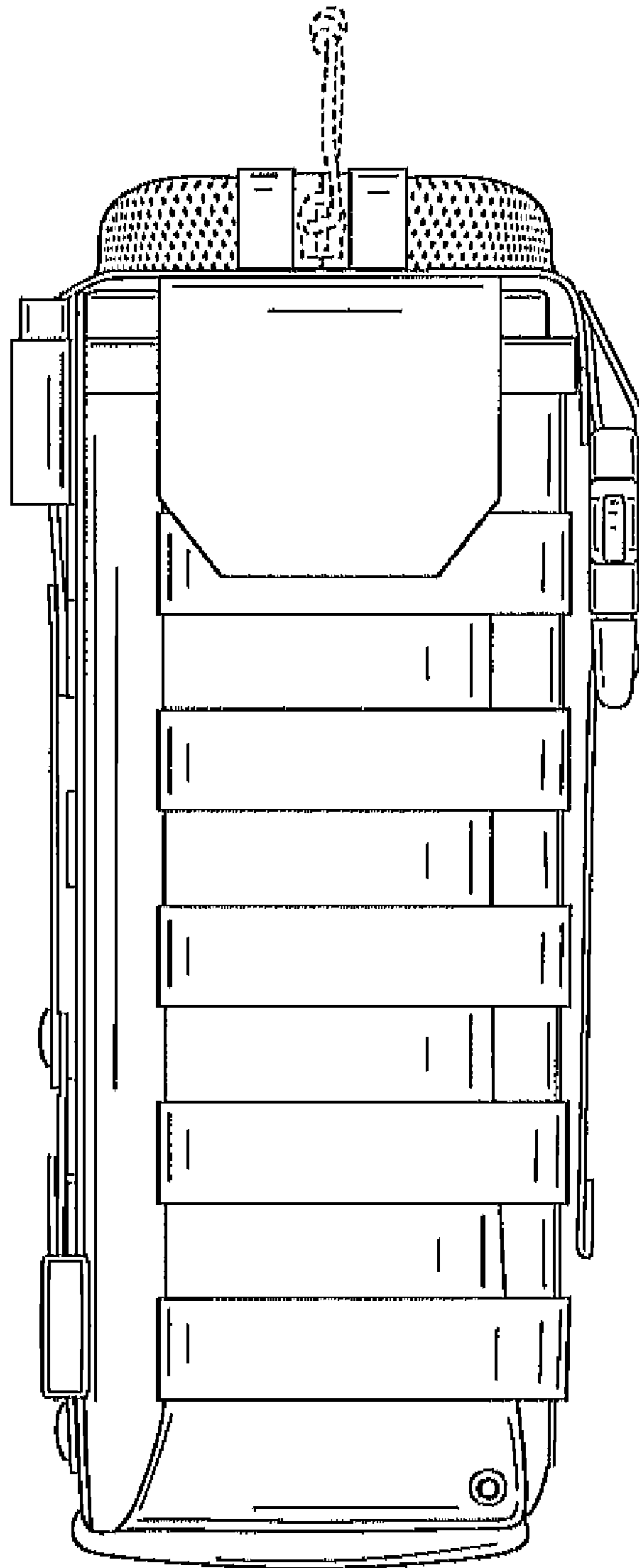

FIG. 5

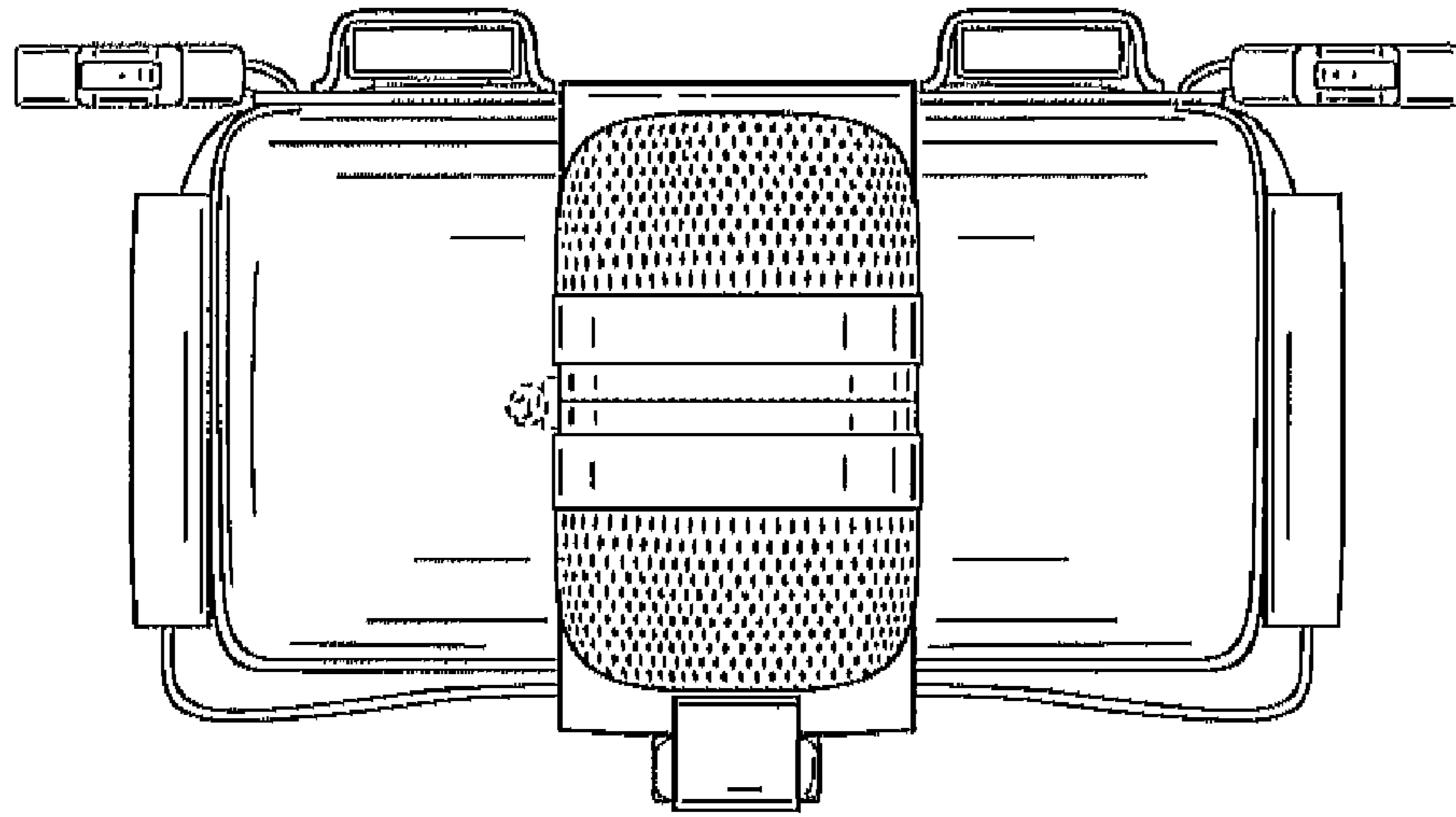

FIG. 6

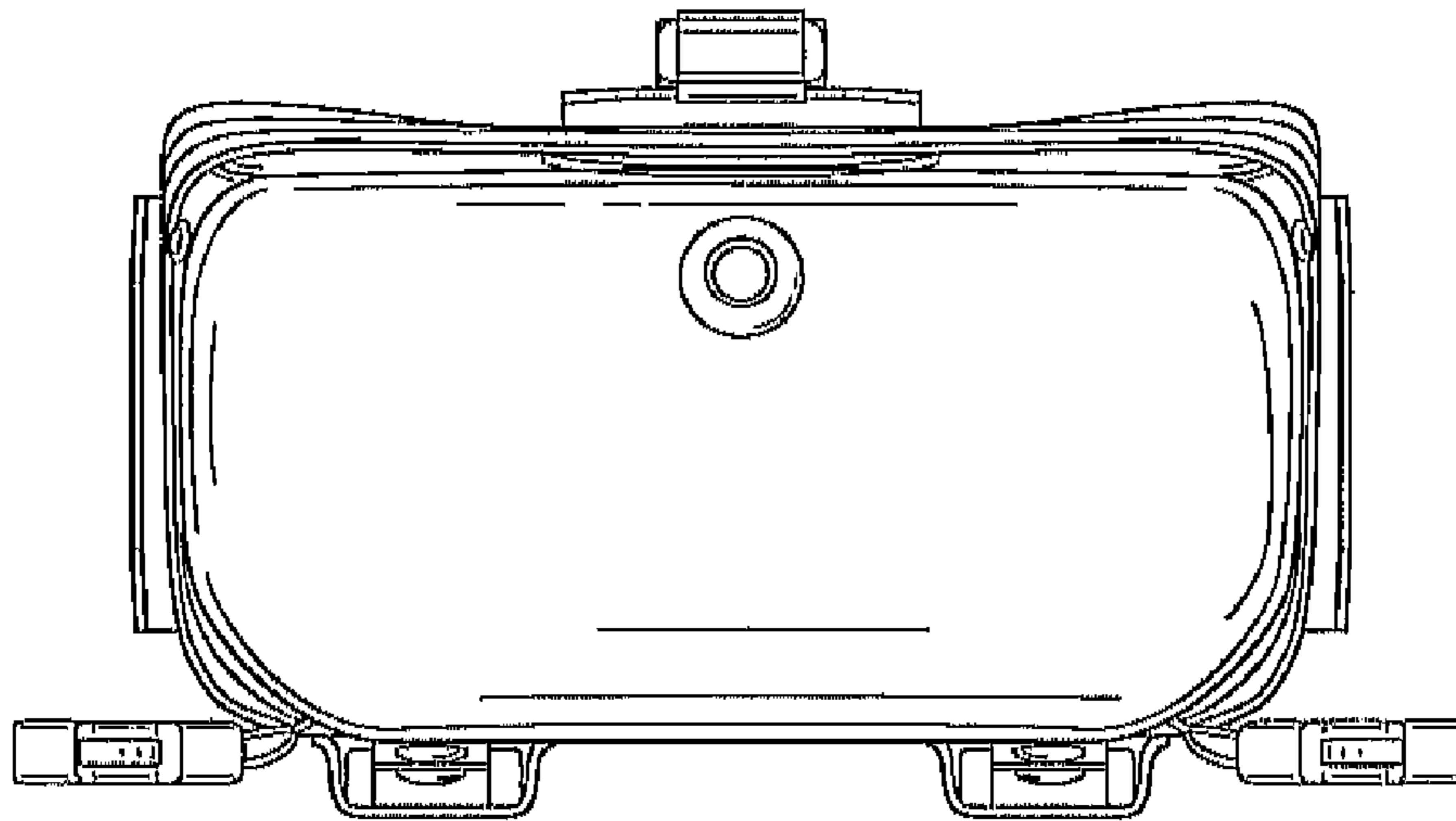

FIG. 7