



US00D659383S

(12) **United States Design Patent**
Phillips et al.

(10) **Patent No.:** **US D659,383 S**
(45) **Date of Patent:** **** May 15, 2012**

(54) **DEVICE HOLSTER**

(75) Inventors: **Alison Phillips**, Toronto (CA); **Todd Nelson Sinclair**, Waterloo (CA); **Anders Fahrendorff**, Ottawa (CA)

(73) Assignee: **Research In Motion Limited**, Waterloo, Ontario (CA)

(**) Term: **14 Years**

(21) Appl. No.: **29/389,885**

(22) Filed: **Apr. 18, 2011**

(51) **LOC (9) Cl.** **03-01**

(52) **U.S. Cl.** **D3/218**

(58) **Field of Classification Search** D3/201,
D3/215–219, 226, 269, 272–273, 265, 247–249;
206/305, 320; 455/90, 92, 42; 379/455,
379/575.1–575.8; 224/250, 666, 674–677,
224/680–683, 240, 901; D14/496, 156, 138,
D14/250, 253

See application file for complete search history.

(56) **References Cited**

U.S. PATENT DOCUMENTS

D382,996 S *	9/1997	Kopel	D3/218
D453,417 S *	2/2002	Badillo et al.	D3/218
D534,720 S *	1/2007	Infanti et al.	D3/218
D587,896 S *	3/2009	Aipa	D3/201
D609,463 S *	2/2010	Bullen	D3/218
D609,900 S *	2/2010	Behar et al.	D3/201

* cited by examiner

Primary Examiner — Catheri Oliver

(57) **CLAIM**

We claim the ornamental design for a device holster, as shown and described.

DESCRIPTION

FIG. 1 is a front perspective view of a device holster;
FIG. 2 is a rear perspective view of the device holster;
FIG. 3 is a front elevational view thereof;
FIG. 4 is a rear elevational view thereof;
FIG. 5 is a right elevational view thereof;
FIG. 6 is a left elevational view thereof;
FIG. 7 is a top plan view thereof; and,
FIG. 8 is a bottom plan view thereof.

1 Claim, 6 Drawing Sheets

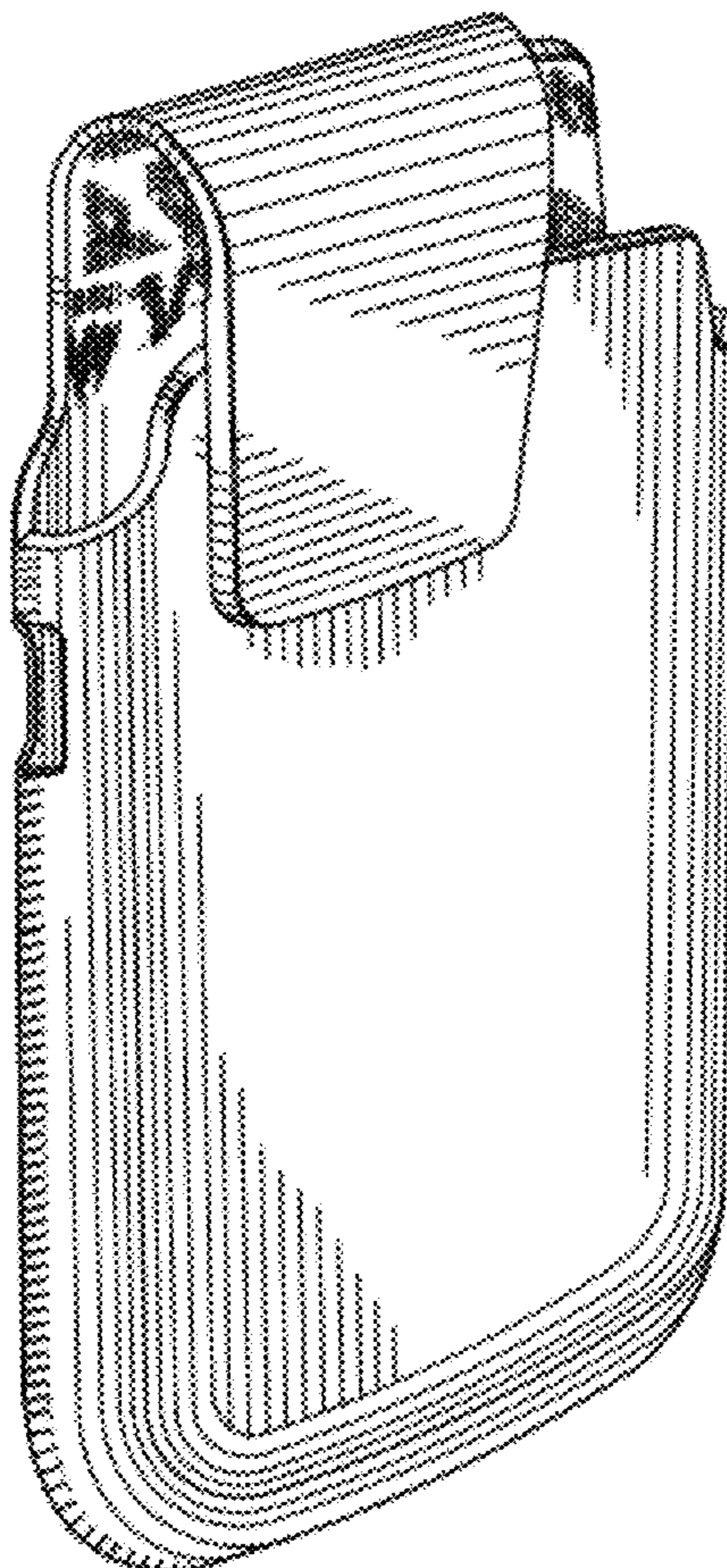

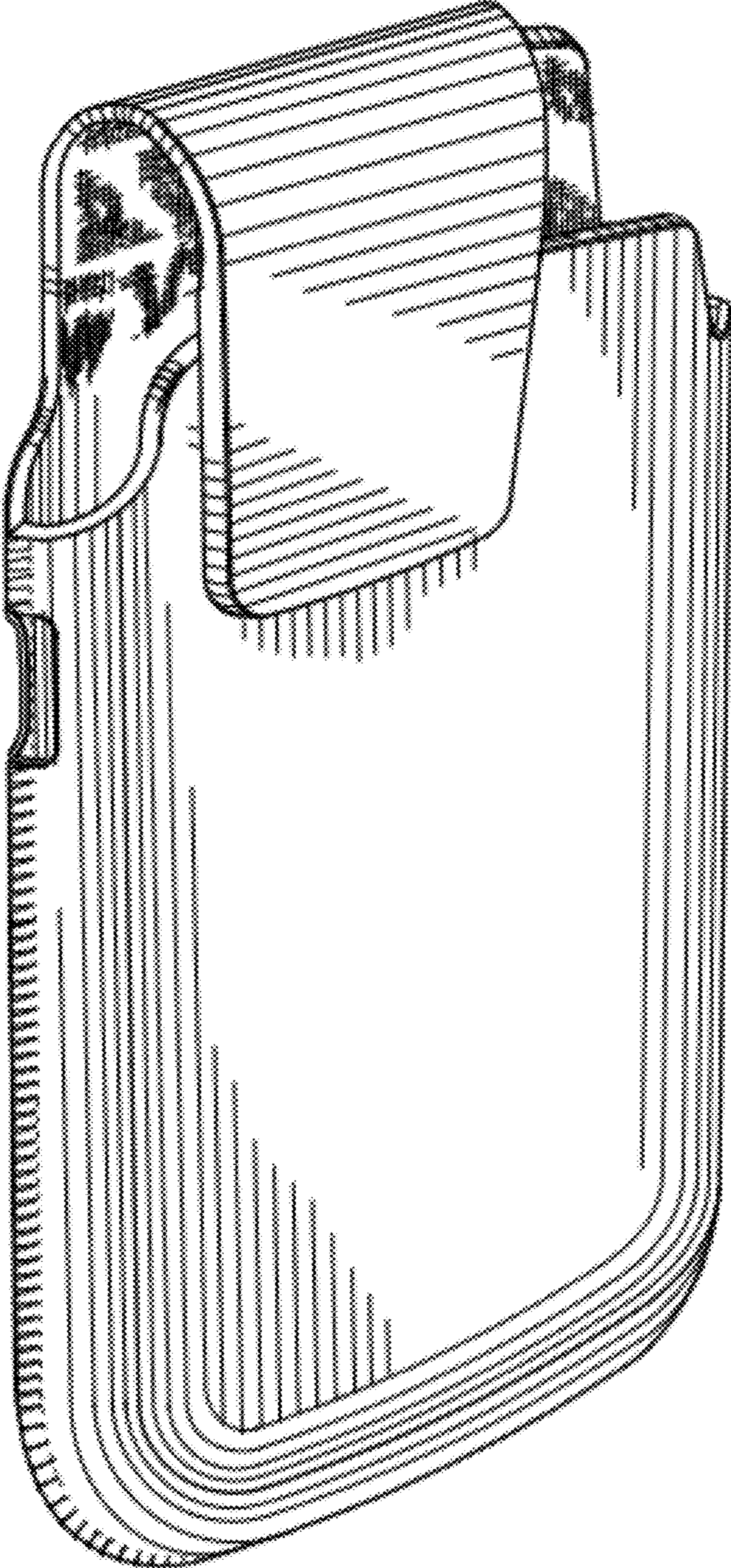

FIG. 1

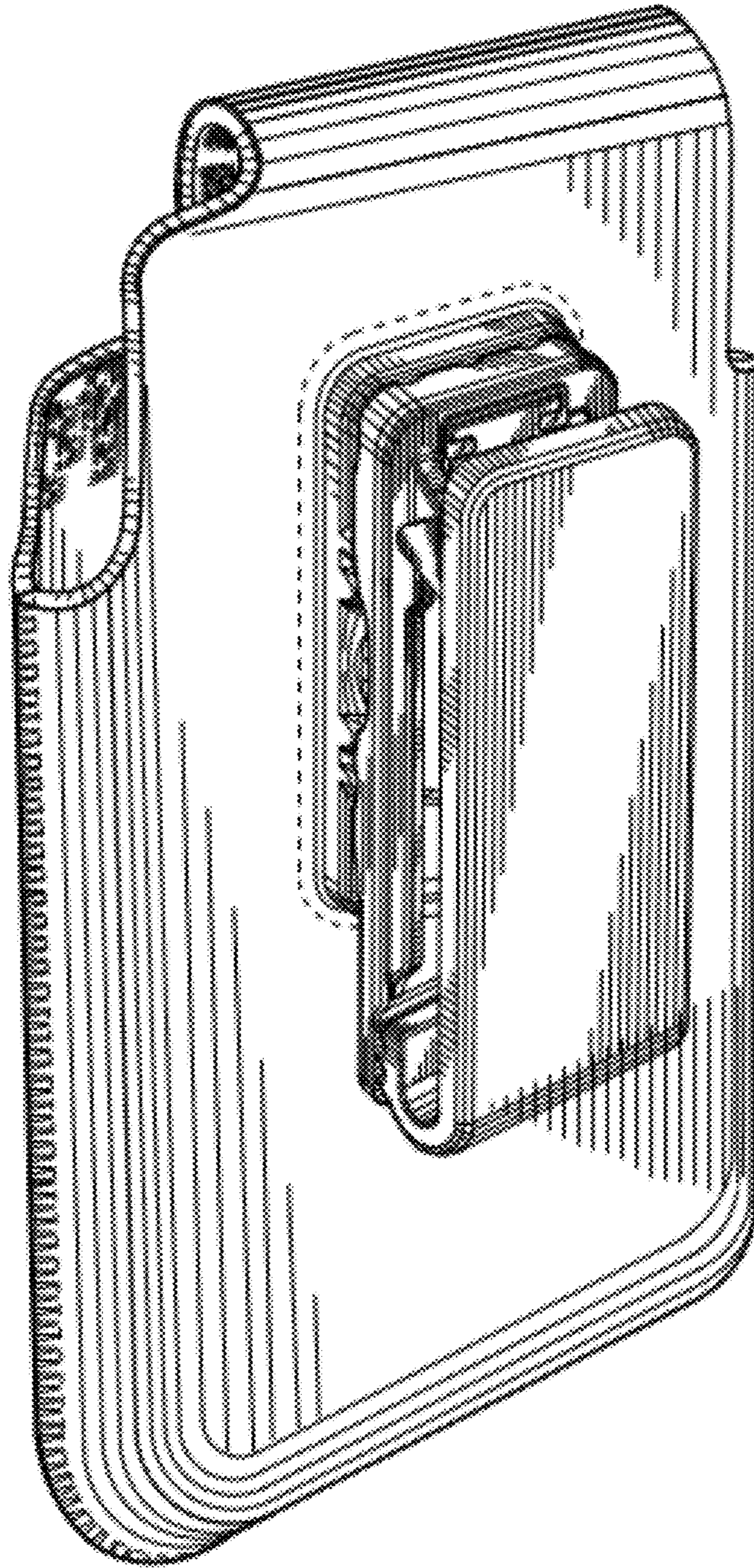

FIG.2

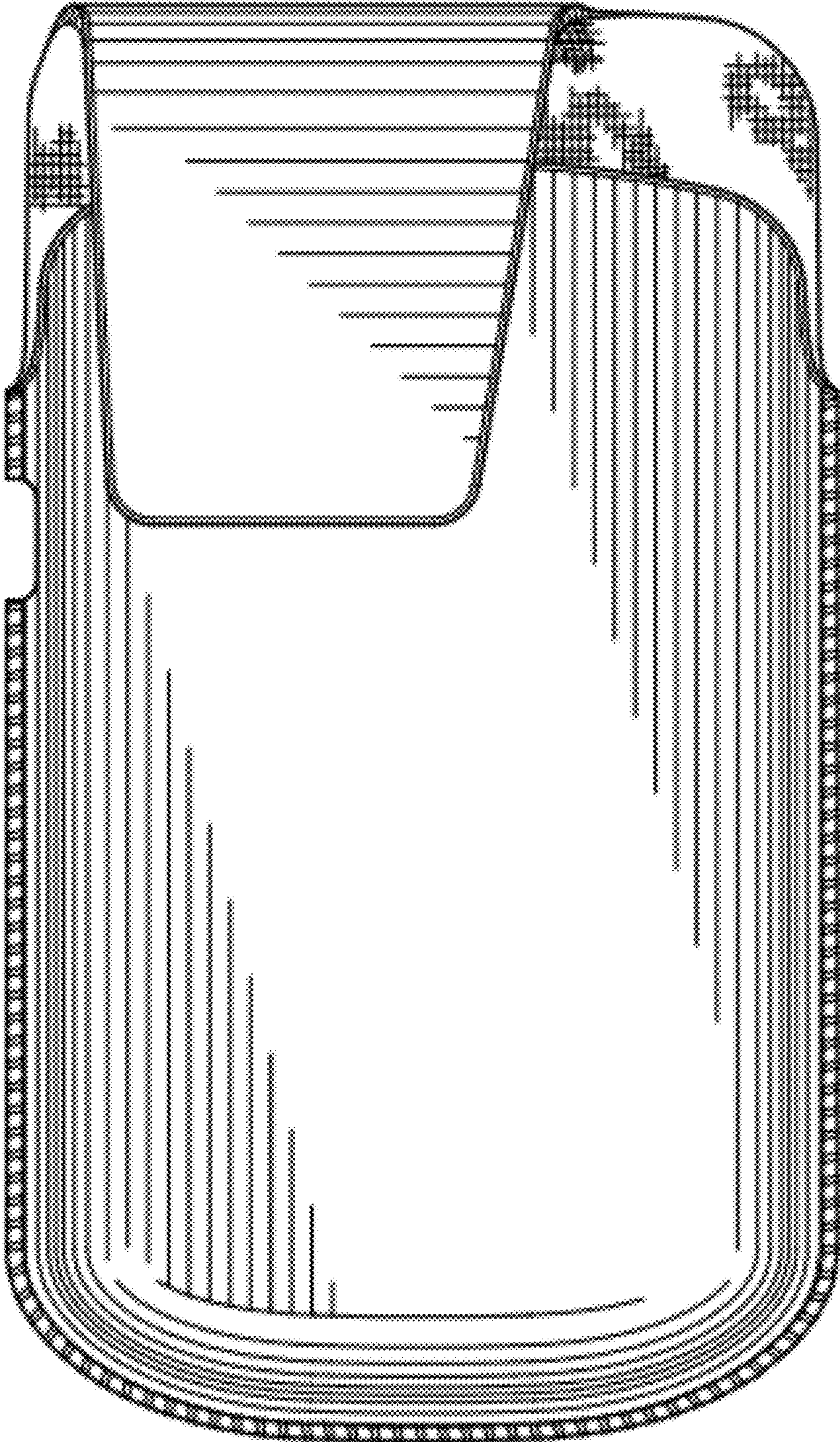

FIG.3

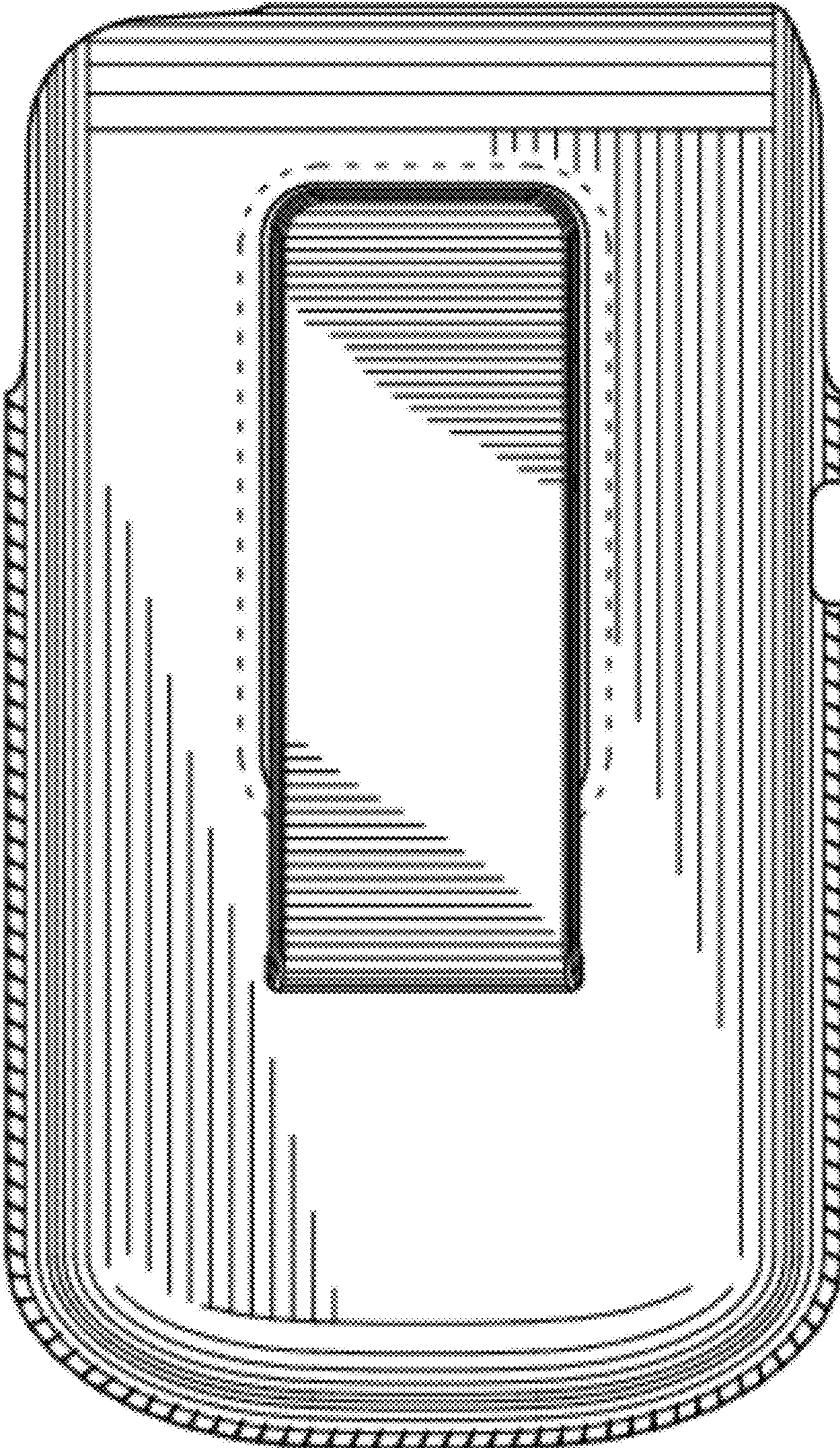

FIG.4

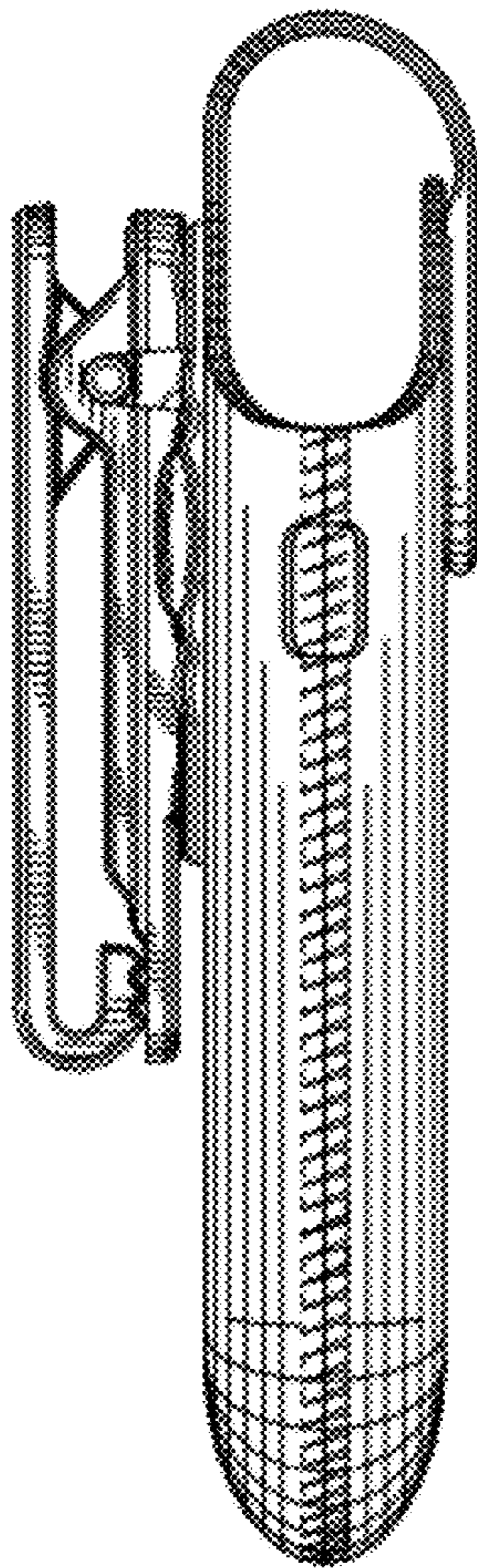

FIG. 5

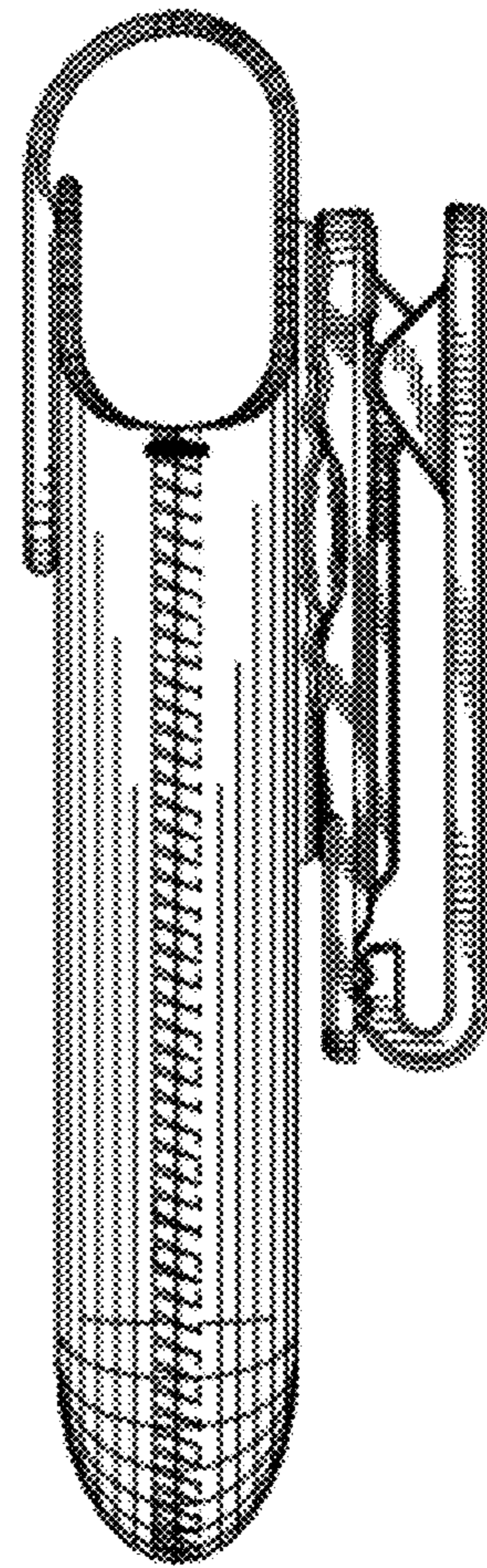

FIG. 6

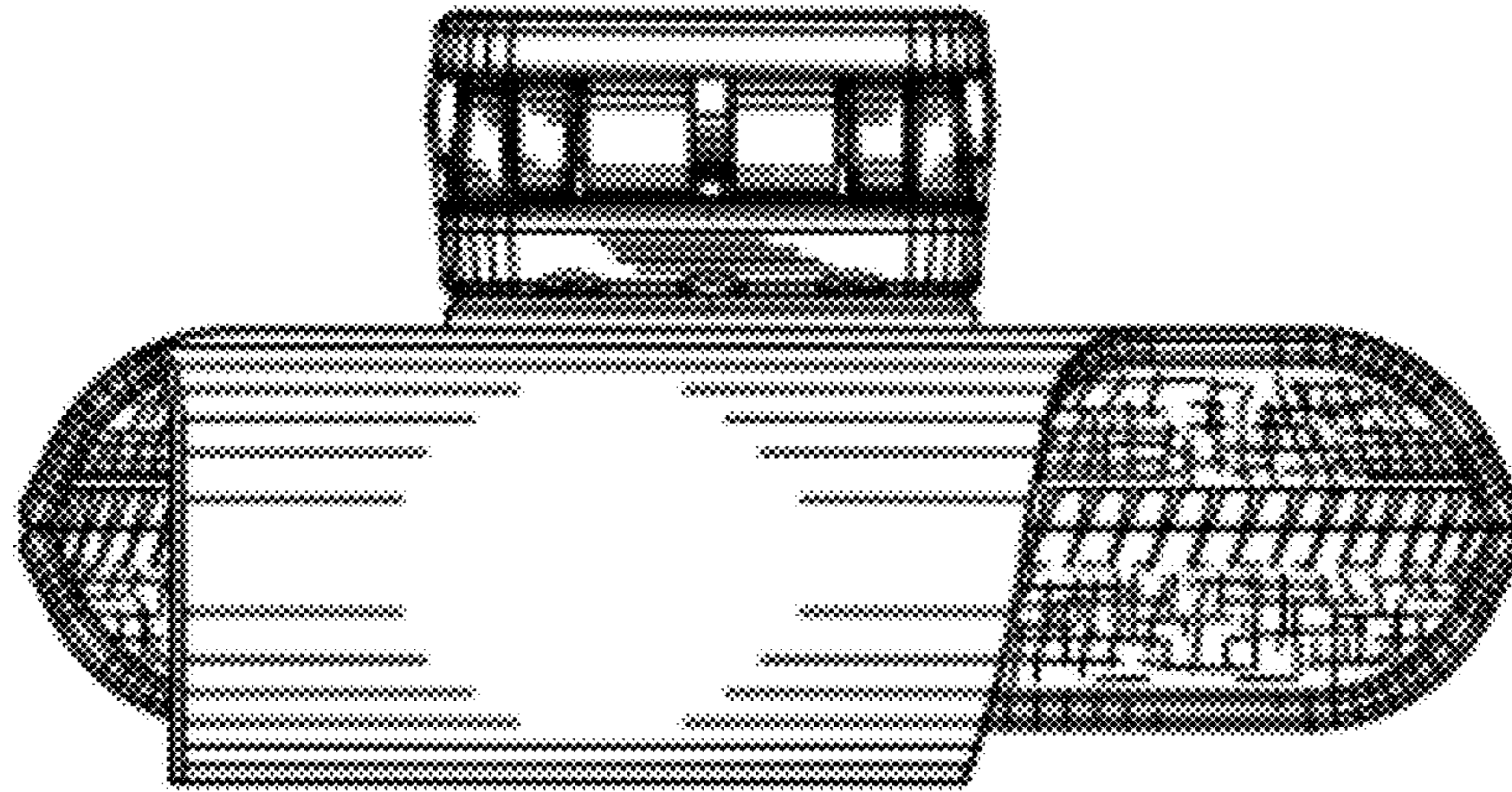

FIG. 7

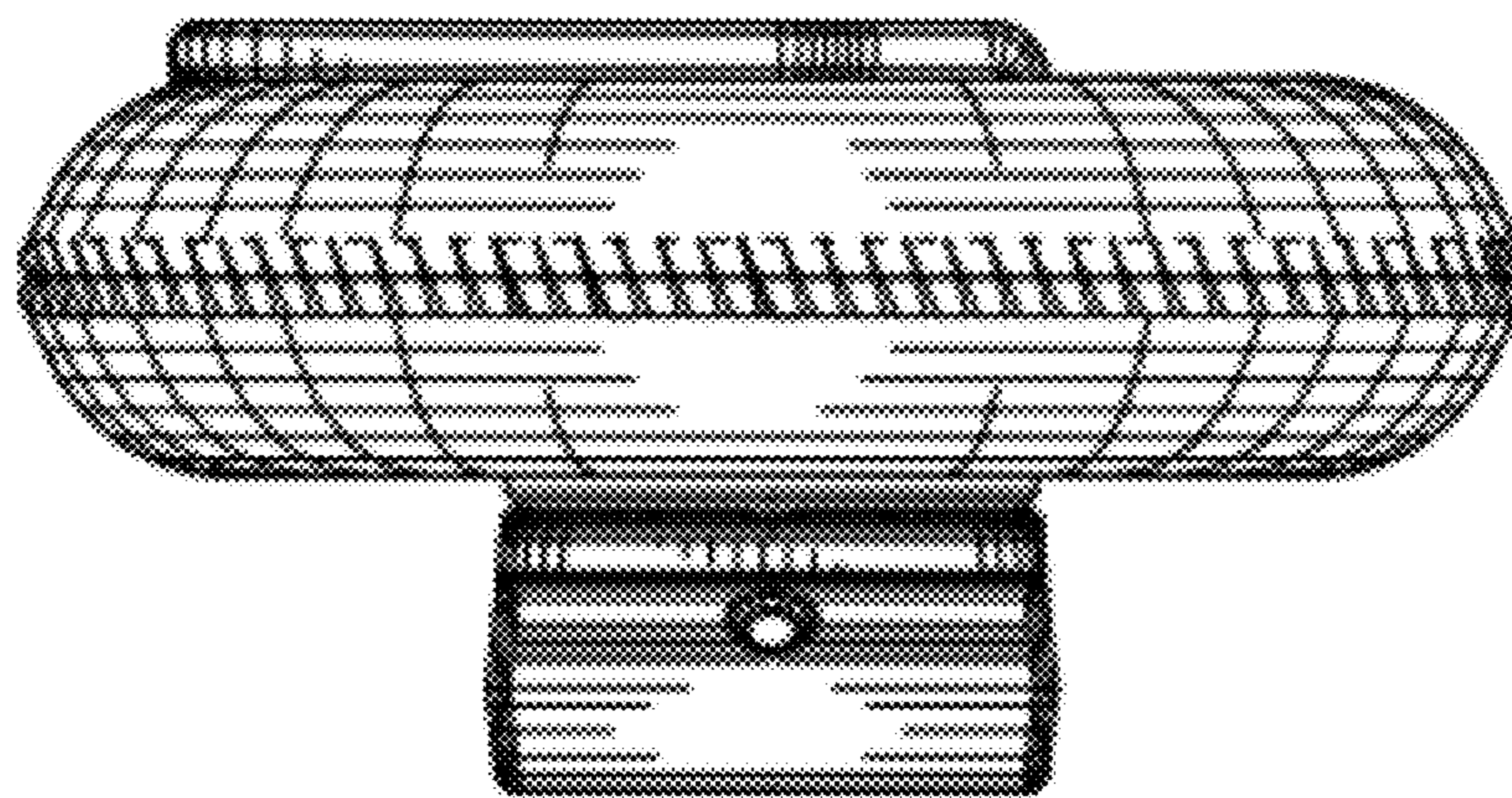

FIG. 8