



US00D659382S

(12) **United States Design Patent**
Fahrendorff et al.

(10) **Patent No.:** **US D659,382 S**

(45) **Date of Patent:** **** *May 15, 2012**

(54) **HOLSTER**

(75) Inventors: **Anders Fahrendorff**, Ottawa (CA);
Andrew David Lowe, Unionville (CA)

(73) Assignee: **Research In Motion**, Waterloo, Ontario
(CA)

(*) Notice: This patent is subject to a terminal disclaimer.

(**) Term: **14 Years**

(21) Appl. No.: **29/377,248**

(22) Filed: **Oct. 19, 2010**

(51) **LOC (9) Cl.** **03-01**

(52) **U.S. Cl.** **D3/218**

(58) **Field of Classification Search** D3/201,
D3/215-219, 226, 269, 272-273, 265, 247-249;
206/305, 320; 455/90, 92, 42; 379/455;
224/250, 666, 674-677, 680-683, 240, 901;
D14/496, 156, 138, 250, 253

See application file for complete search history.

(56) **References Cited**

U.S. PATENT DOCUMENTS

D534,720 S * 1/2007 Infanti et al. D3/218
D606,299 S * 12/2009 Boomhour et al. D3/201
D606,301 S * 12/2009 Hofer et al. D3/218

* cited by examiner

Primary Examiner — Catheri Oliver

(57) **CLAIM**

We claim the ornamental design for a holster, as shown and described.

DESCRIPTION

FIG. 1 is a front perspective view of a holster;
FIG. 2 is a rear perspective view of the holster;
FIG. 3 is a front elevational view thereof;
FIG. 4 is a rear elevational view thereof;
FIG. 5 is a right elevational view thereof;
FIG. 6 is a left elevational view thereof;
FIG. 7 is a top plan view thereof; and,
FIG. 8 is a bottom plan view thereof.

1 Claim, 6 Drawing Sheets

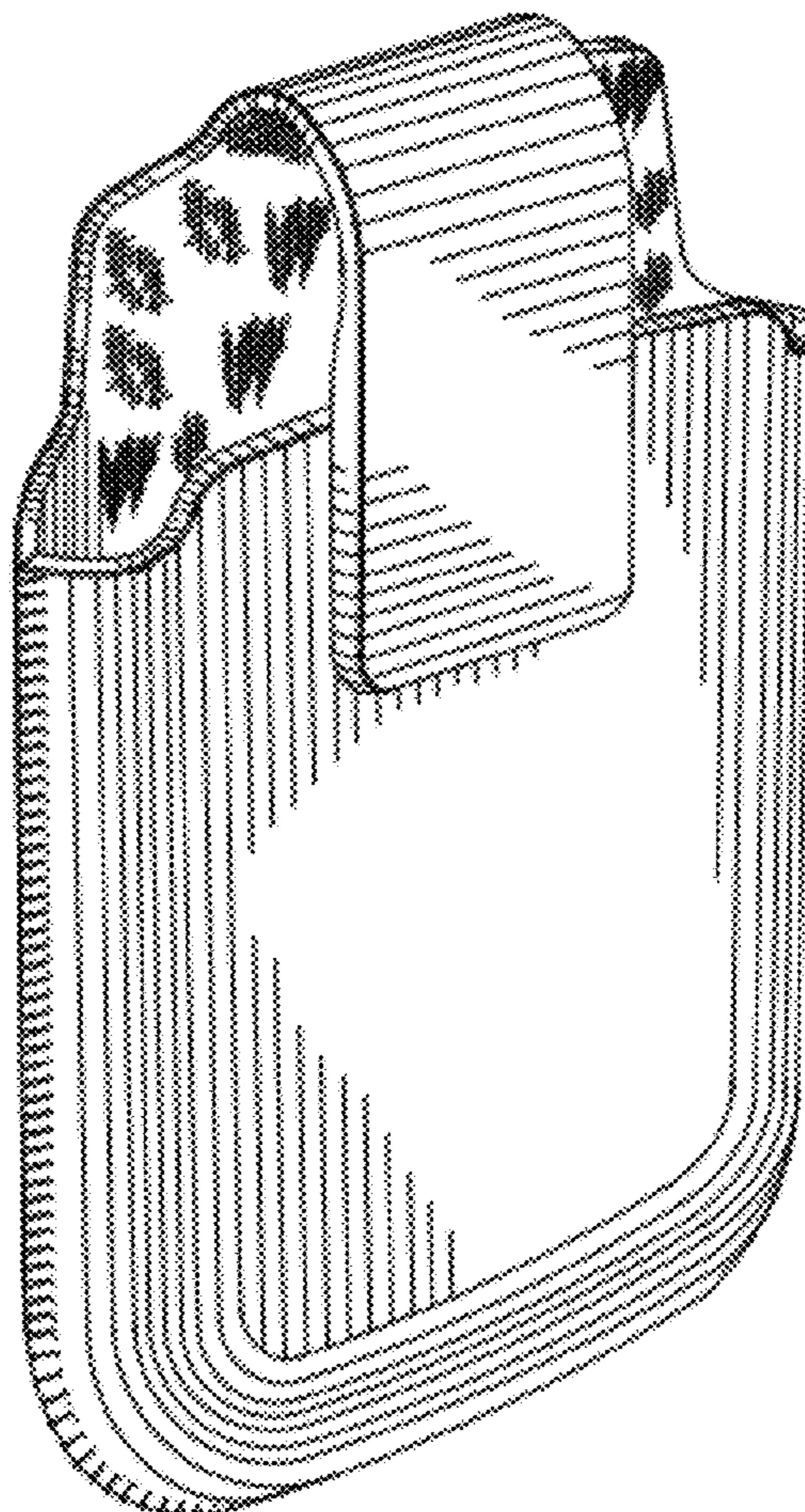

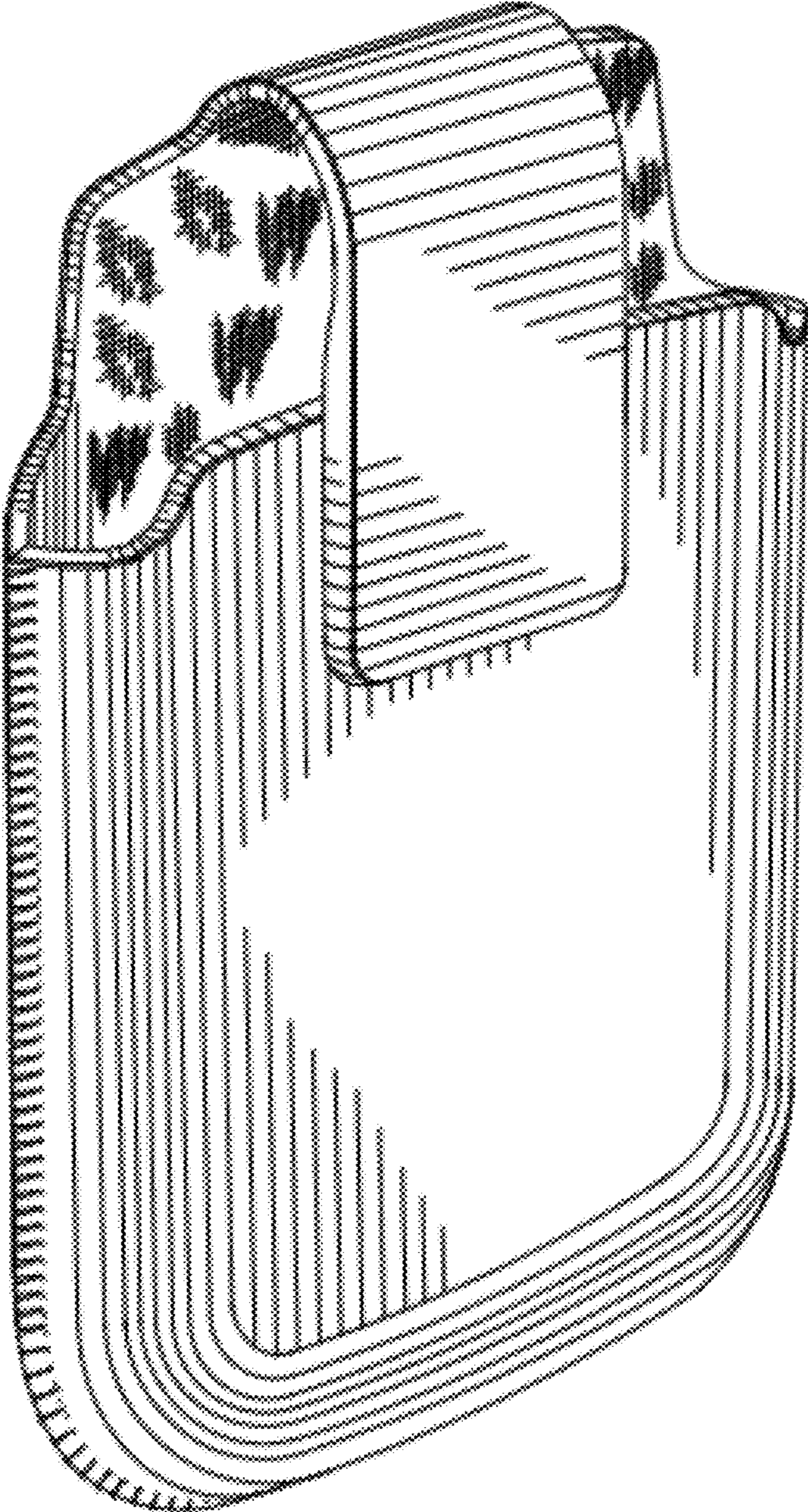

FIG. 1

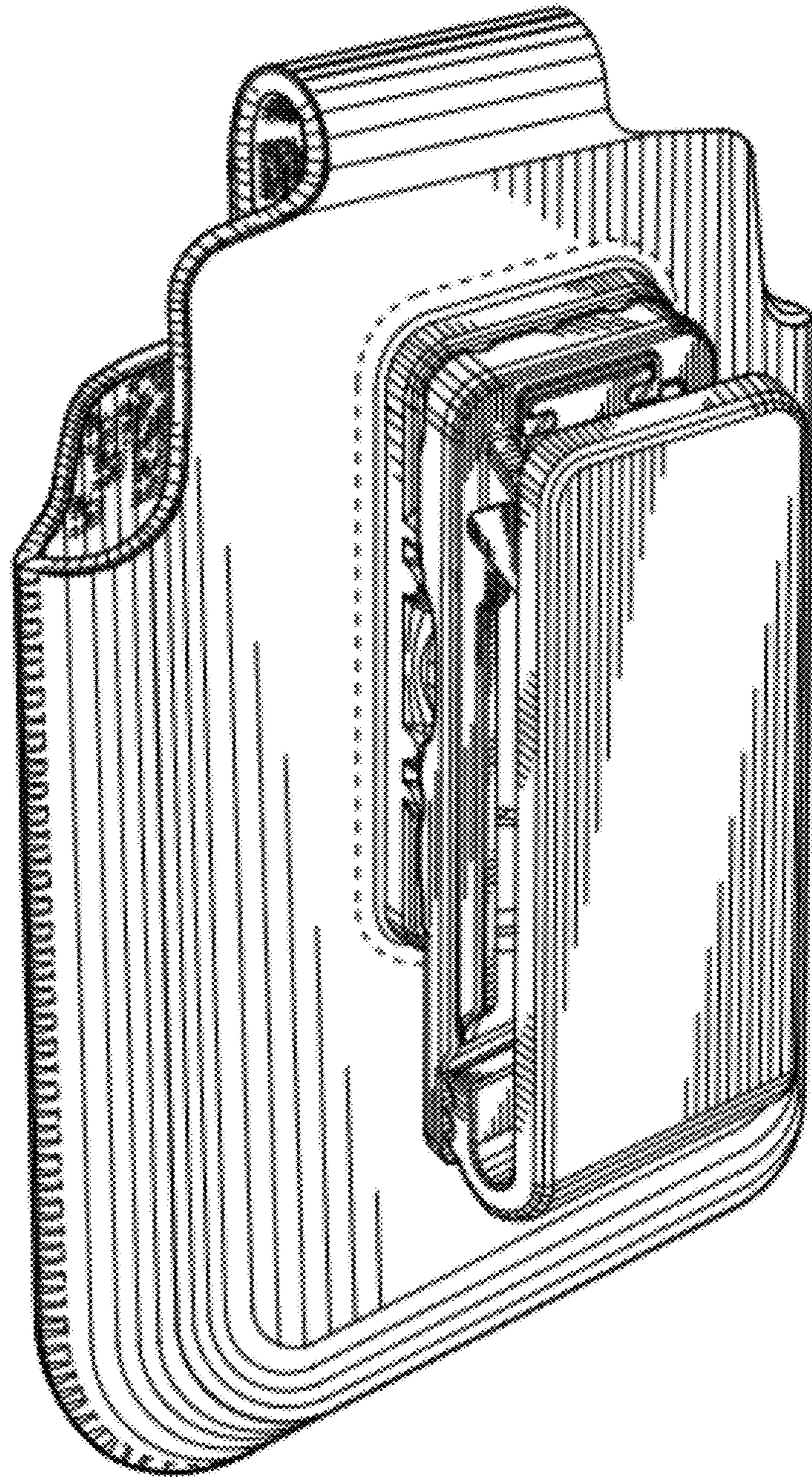

FIG.2

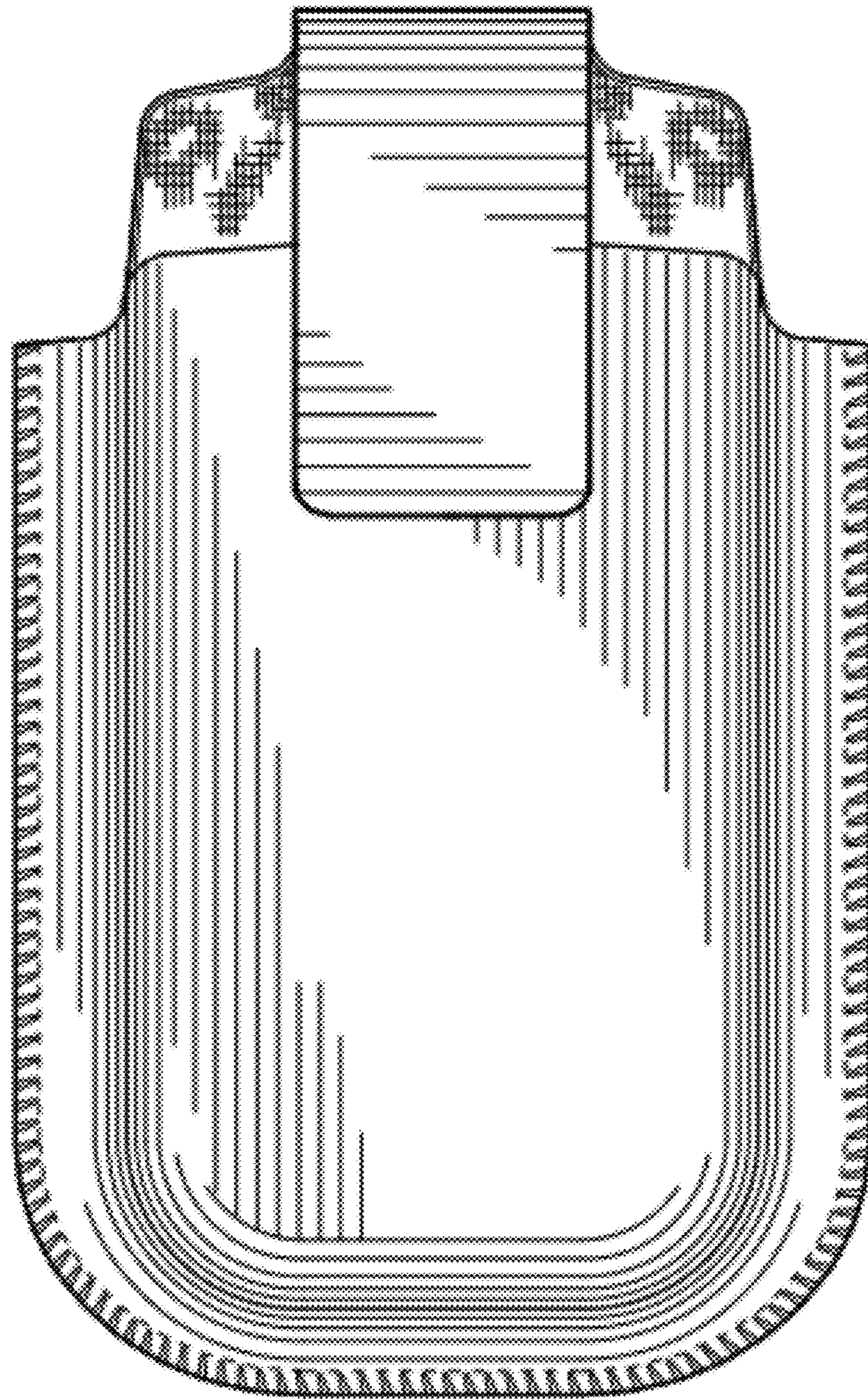

FIG.3

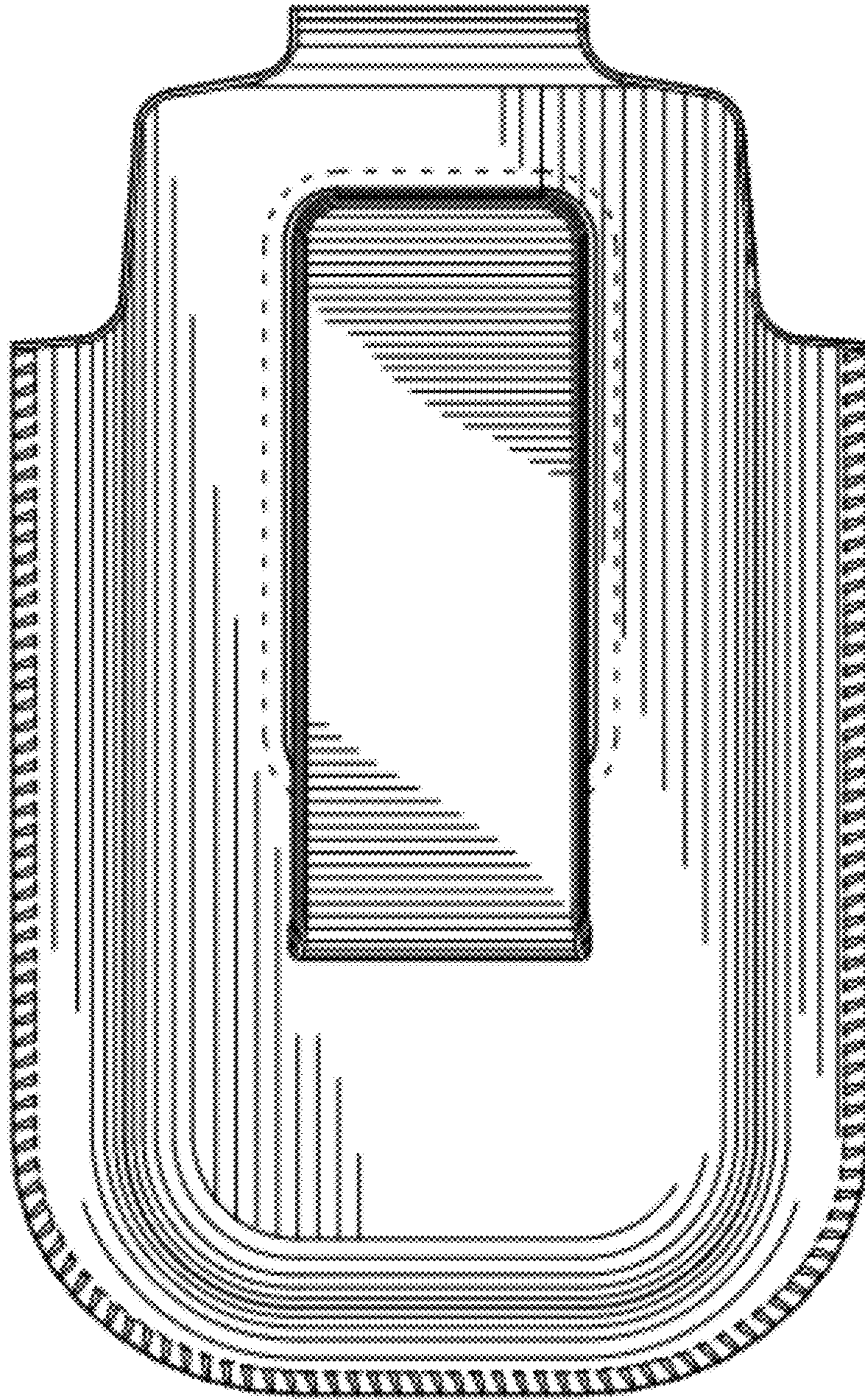

FIG.4

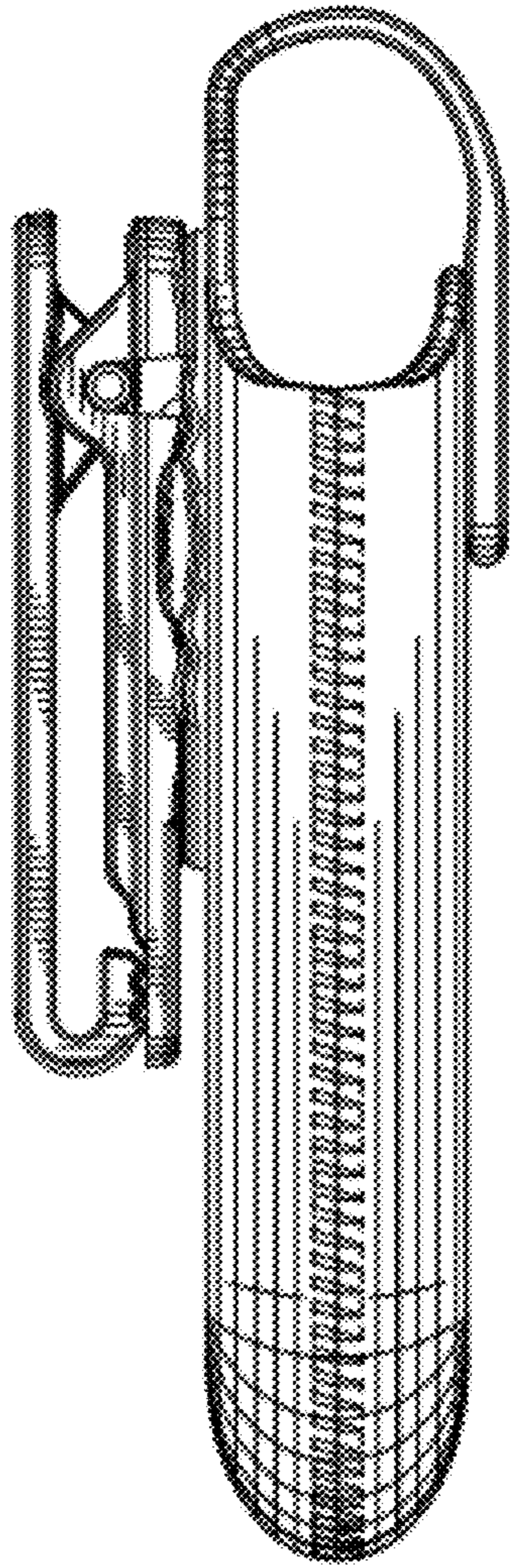

FIG. 5

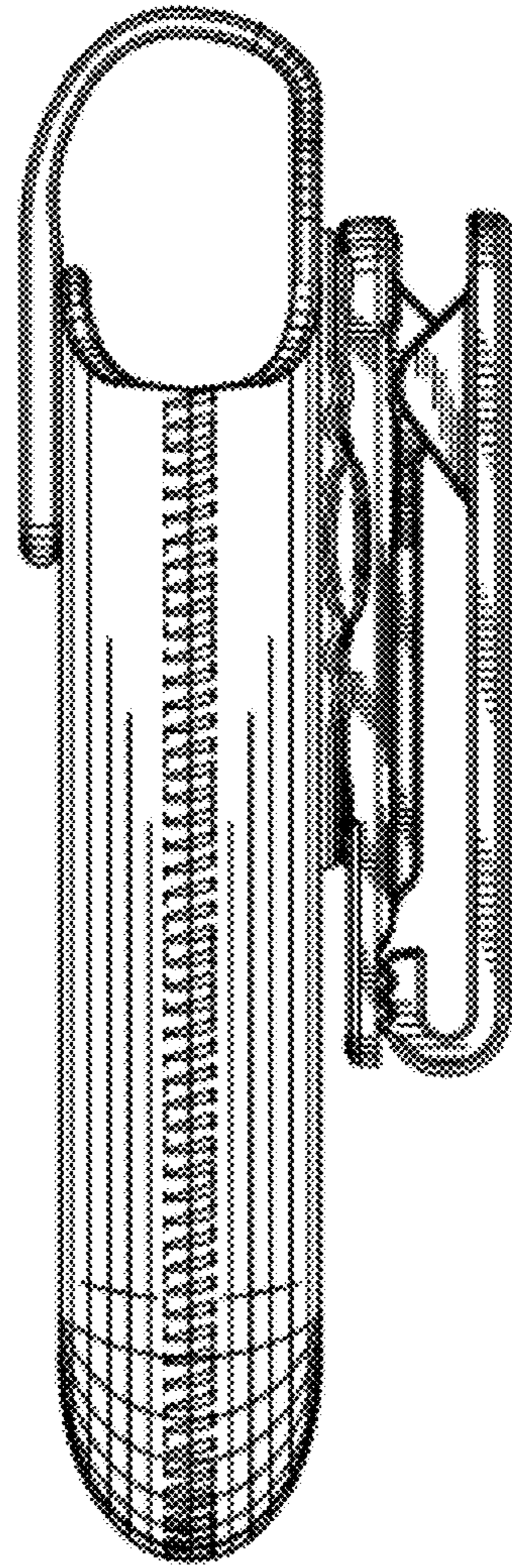

FIG. 6

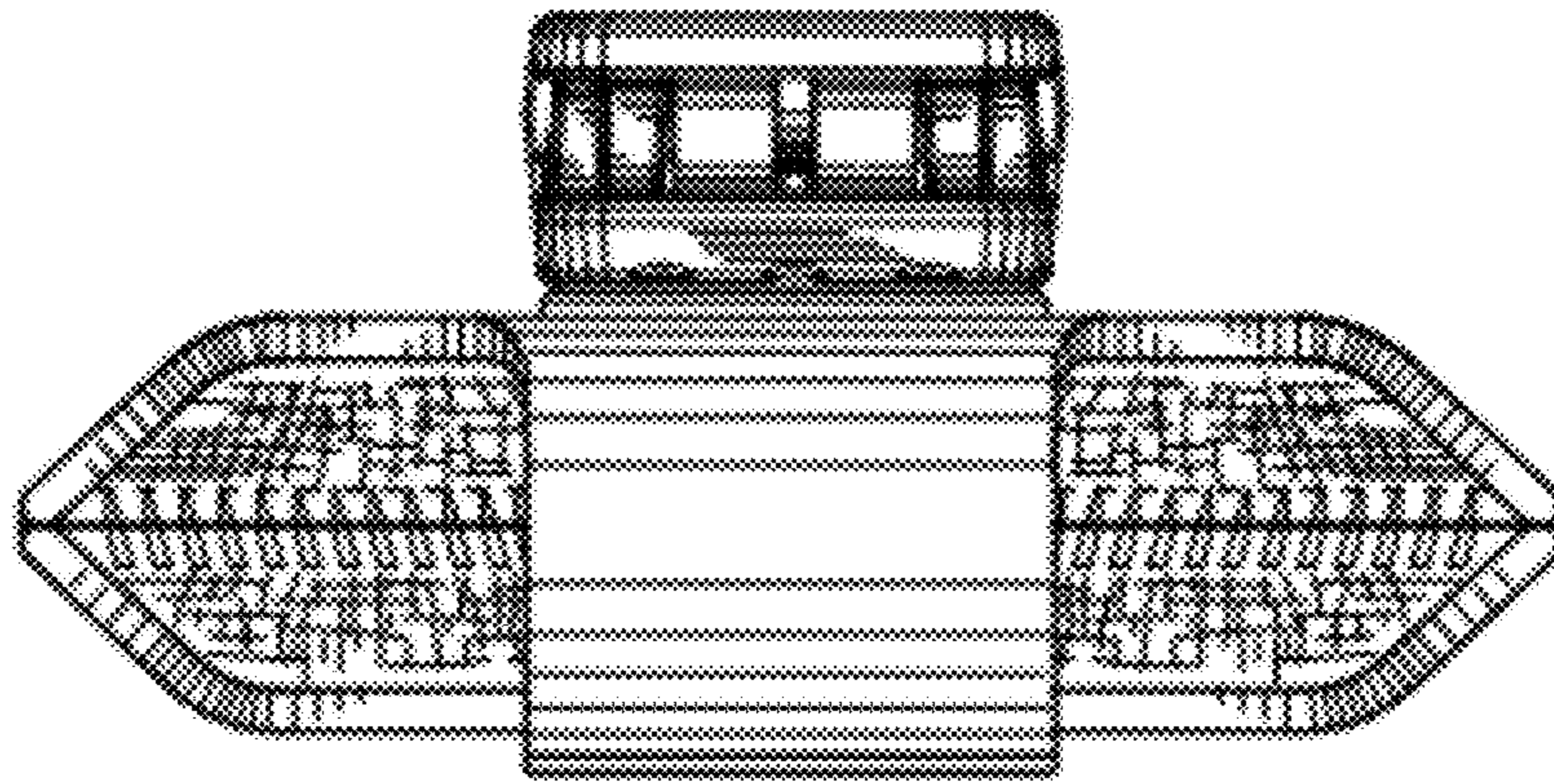

FIG. 7

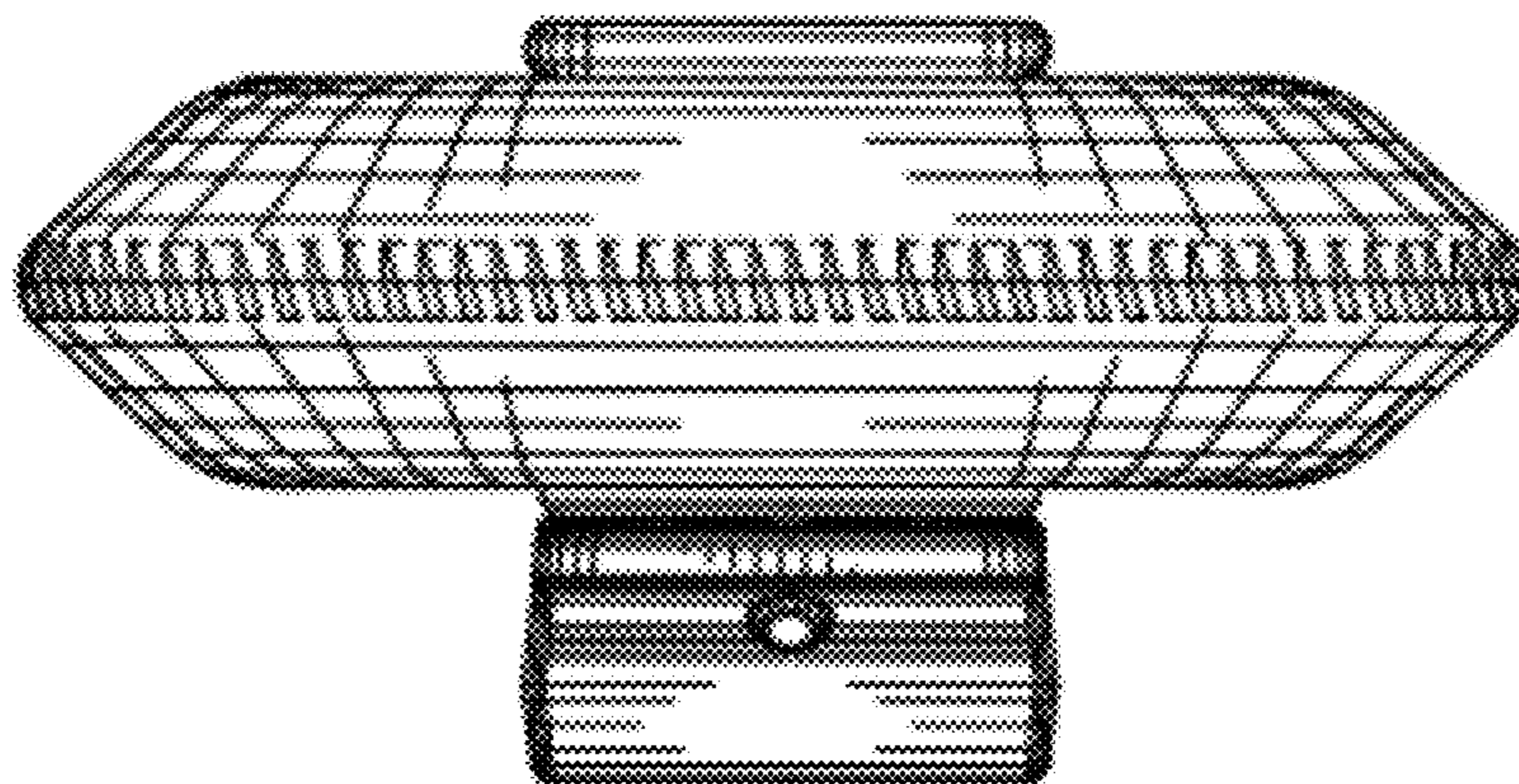

FIG. 8

UNITED STATES PATENT AND TRADEMARK OFFICE
CERTIFICATE OF CORRECTION

PATENT NO. : D659,382 S
APPLICATION NO. : 29/377248
DATED : May 15, 2012
INVENTOR(S) : Anders Fahrenдорff and Andrew David Lowe

Page 1 of 1

It is certified that error appears in the above-identified patent and that said Letters Patent is hereby corrected as shown below:

On the Title Page item (73), the Assignee should be:

Research In Motion Limited

Signed and Sealed this
Thirteenth Day of November, 2012

A handwritten signature in black ink that reads "David J. Kappos". The signature is written in a cursive, slightly slanted style.

David J. Kappos
Director of the United States Patent and Trademark Office