



US00D659353S

(12) **United States Design Patent**
Miller

(10) **Patent No.:** **US D659,353 S**
(45) **Date of Patent:** **** May 15, 2012**

(54) **GAITER**

(76) Inventor: **Cheryl Miller**, Lakewood, CO (US)

(**) Term: **14 Years**

(21) Appl. No.: **29/404,360**

(22) Filed: **Oct. 19, 2011**

Related U.S. Application Data

(62) Division of application No. 29/383,926, filed on Jan. 24, 2011, now Pat. No. Des. 649,333.

(51) **LOC (9) Cl.** **02-04**

(52) **U.S. Cl.** **D2/901**

(58) **Field of Classification Search** D02/897,
D02/901, 910-913, 946, 970, 971; 36/2 R,
36/7.2, 7.3, 7.1 R, 100, 101, 45; 2/61; D24/190,
D24/192

See application file for complete search history.

(56) **References Cited**

U.S. PATENT DOCUMENTS

D62,741 S	7/1923	Nichols	
D64,218 S	3/1924	Timson	
1,794,506 A *	3/1931	Anderson	36/2 R
D150,473 S	11/1947	Stalie	
2,532,024 A *	11/1950	Hoffman	36/2 R
4,001,953 A *	1/1977	Fugere et al.	36/2 R
D270,869 S	10/1983	Kronberg	
4,896,437 A *	1/1990	Johnson	36/1.5
D345,252 S	3/1994	Randall	
D371,452 S *	7/1996	Graves	D2/901
5,642,573 A *	7/1997	Brown	36/2 R
D396,740 S	8/1998	Magliulo	
5,815,948 A *	10/1998	Dzielak	36/2 R
5,887,359 A *	3/1999	Falguere	36/2 R
6,185,752 B1 *	2/2001	Hendersen et al.	2/242

D520,218 S	5/2006	Mayers
D551,828 S	10/2007	Winjum
D564,187 S	3/2008	Webb

OTHER PUBLICATIONS

Notice of Allowance and Fee(s) Due for U.S. Appl. No. 29/383,926, mailed Jul. 21, 2011, 9 pages.

* cited by examiner

Primary Examiner — Robert M Spear

Assistant Examiner — Rashida C McCoy

(74) *Attorney, Agent, or Firm* — Sheridan Ross P.C.

(57) **CLAIM**

The ornamental design for a gaiter, as shown and described.

DESCRIPTION

FIG. 1 is a perspective view of a gaiter showing my new design;

FIG. 2 is a first side elevation view thereof;

FIG. 3 is a second side elevation view thereof;

FIG. 4 is a rear elevation view thereof;

FIG. 5 is a front elevation view thereof;

FIG. 6 is a top plan view thereof; and

FIG. 7 is a bottom plan view thereof.

FIG. 8 is a perspective view of a second embodiment of a gaiter showing my new design;

FIG. 9 is a first side elevation view thereof;

FIG. 10 is a second side elevation view thereof;

FIG. 11 is a rear elevation view thereof;

FIG. 12 is a front elevation view thereof;

FIG. 13 is a top plan view thereof; and,

FIG. 14 is a bottom plan view thereof.

The larger broken lines represent claimed stitching. The smaller broken lines illustrate unclaimed environmental structure.

1 Claim, 12 Drawing Sheets

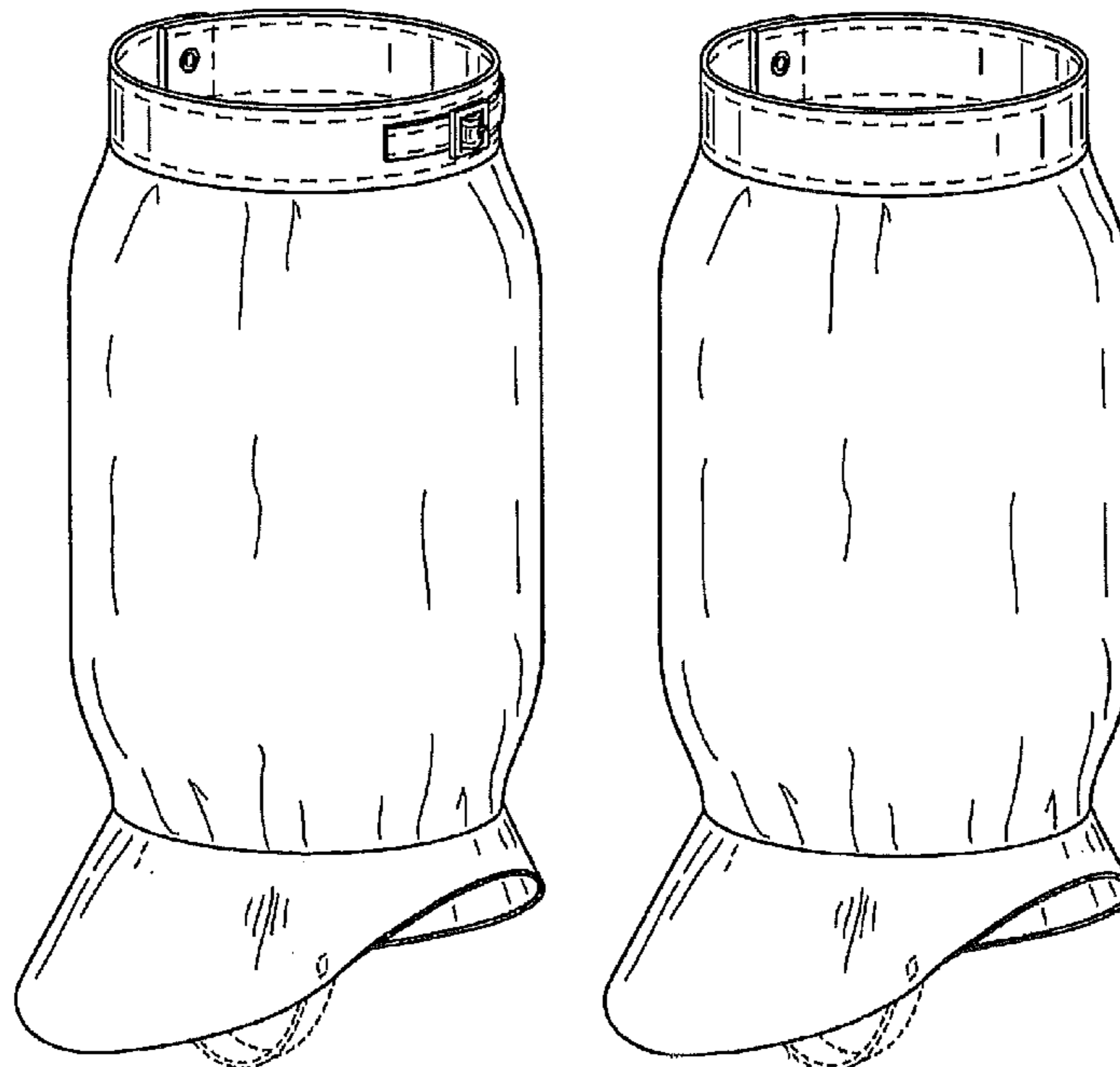

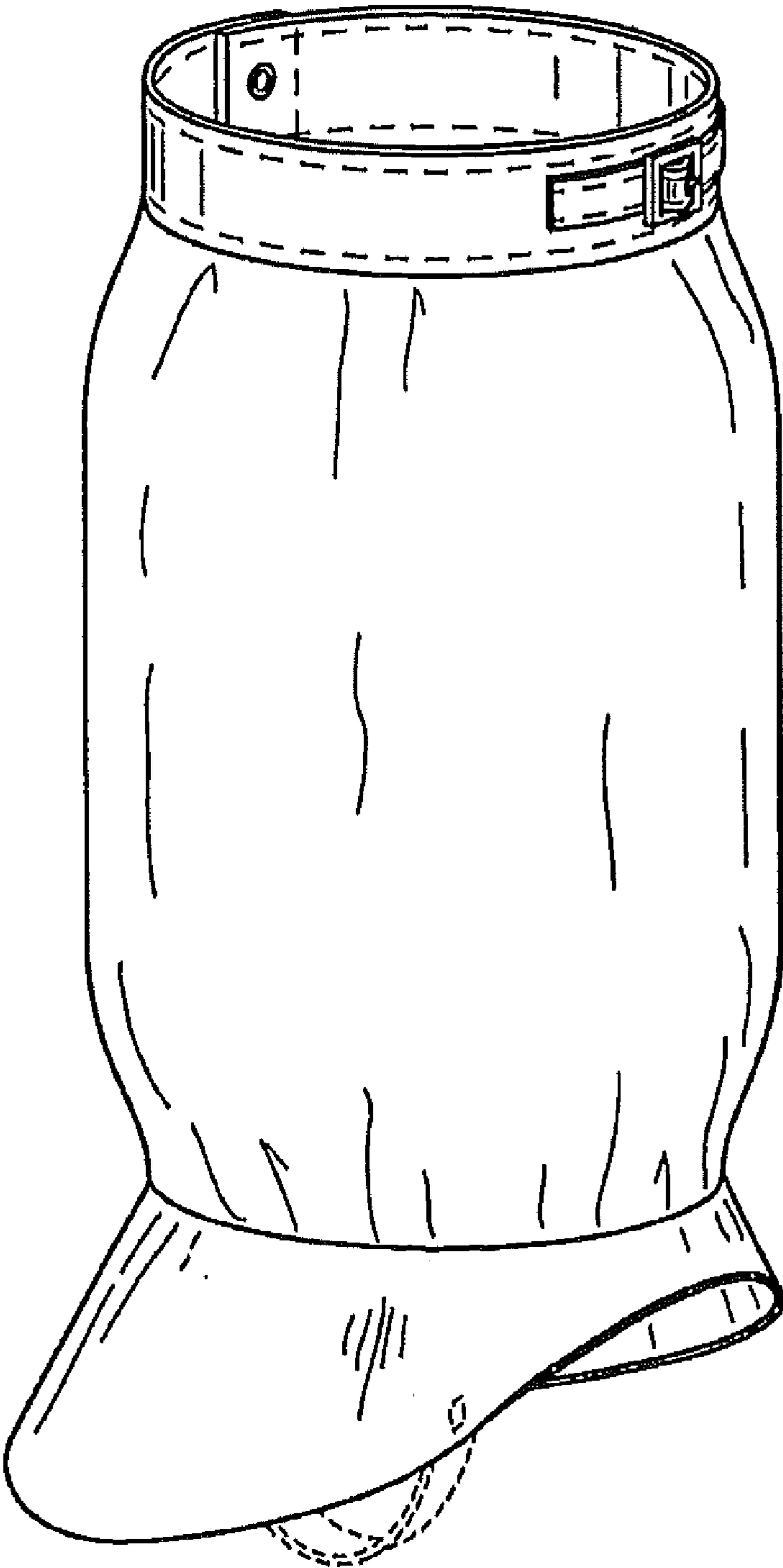

FIG. 1

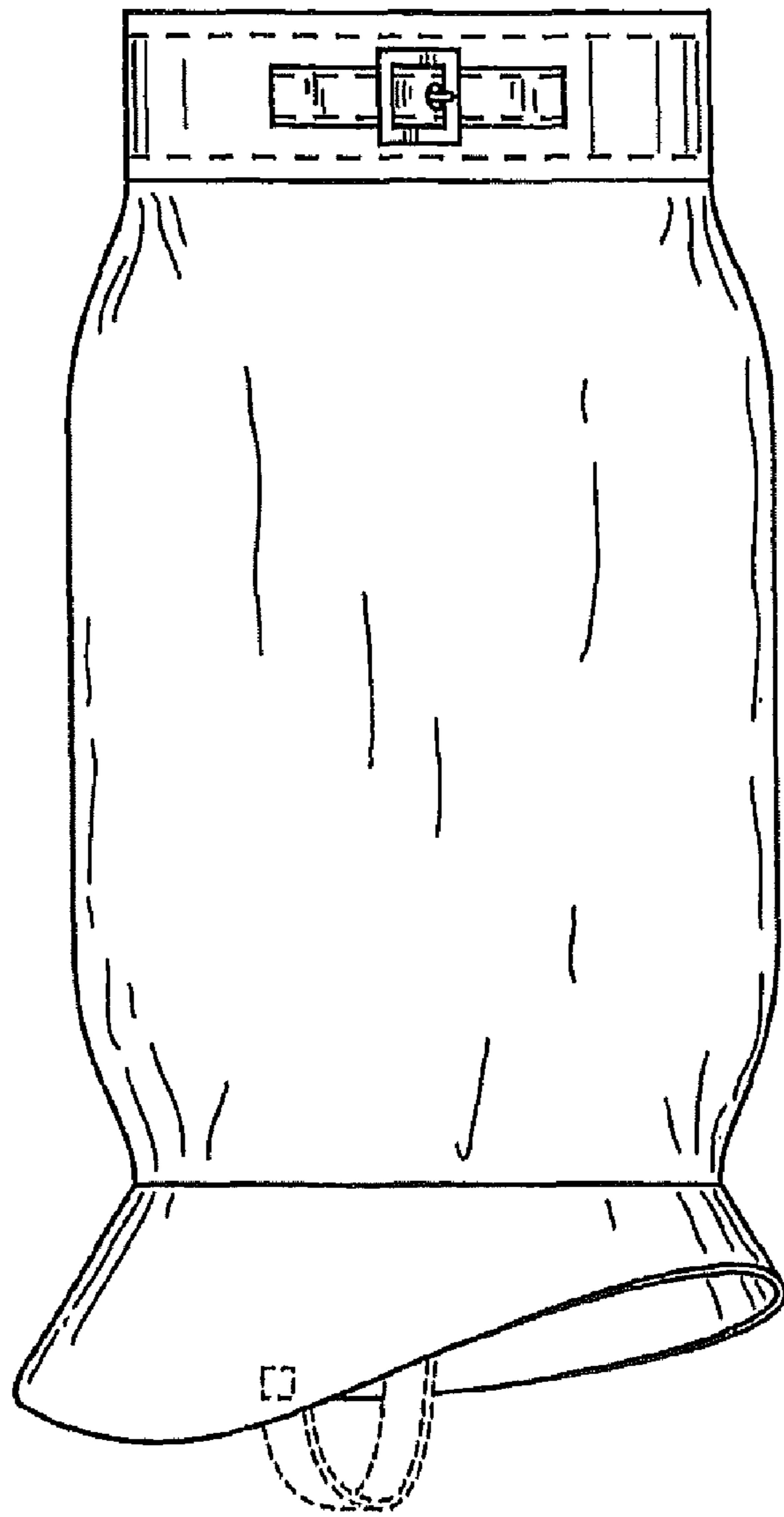

FIG.2

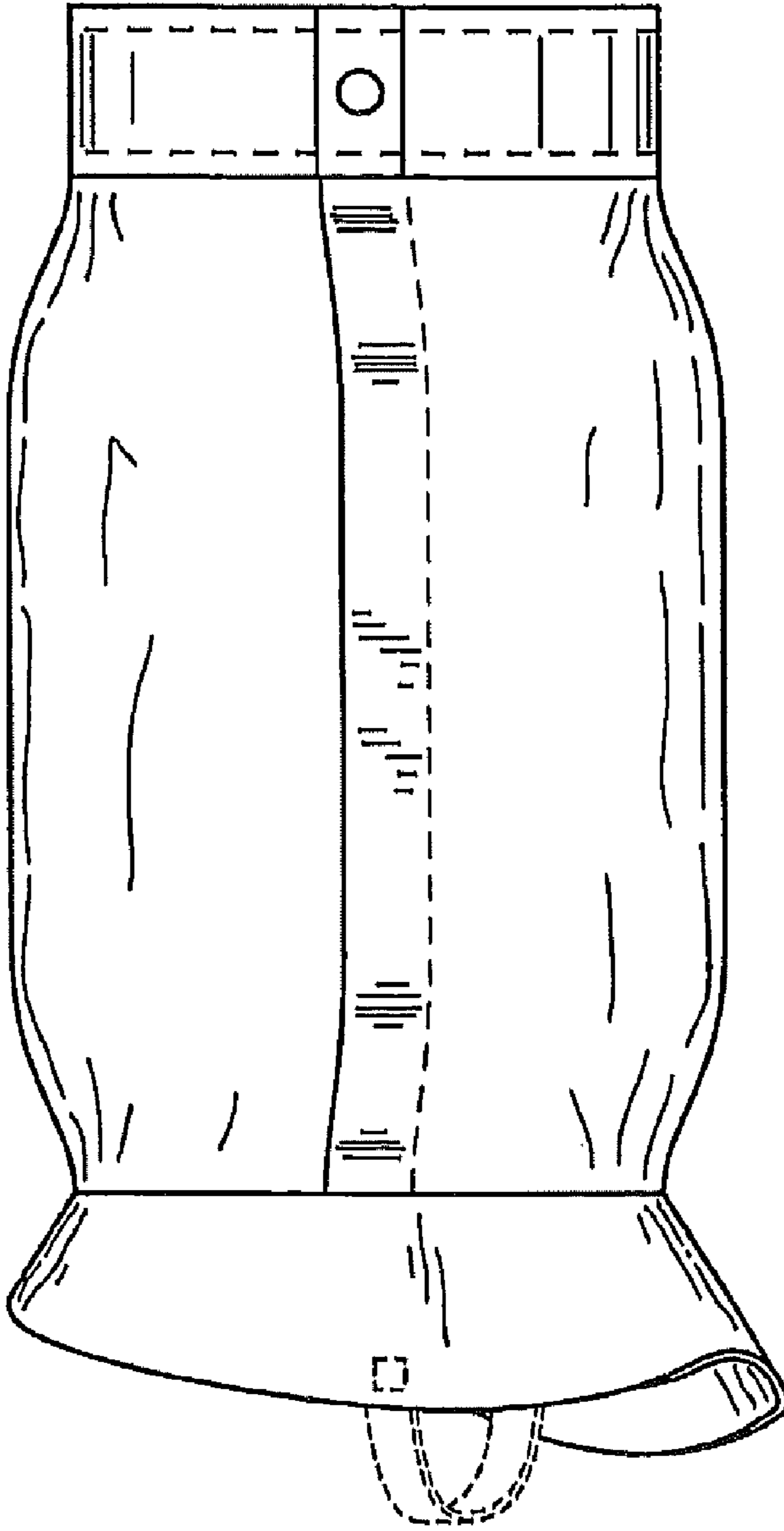

FIG.3

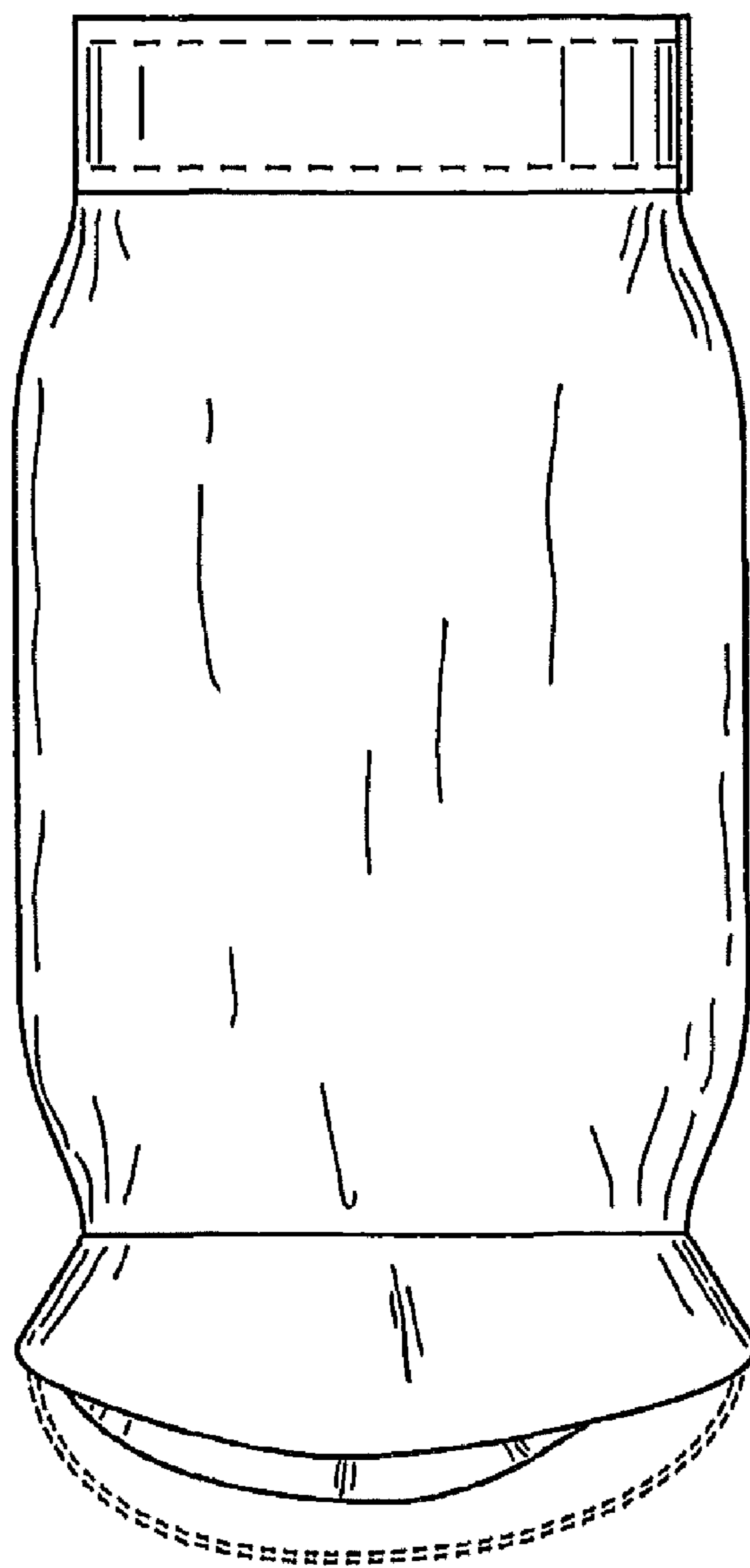

FIG.4

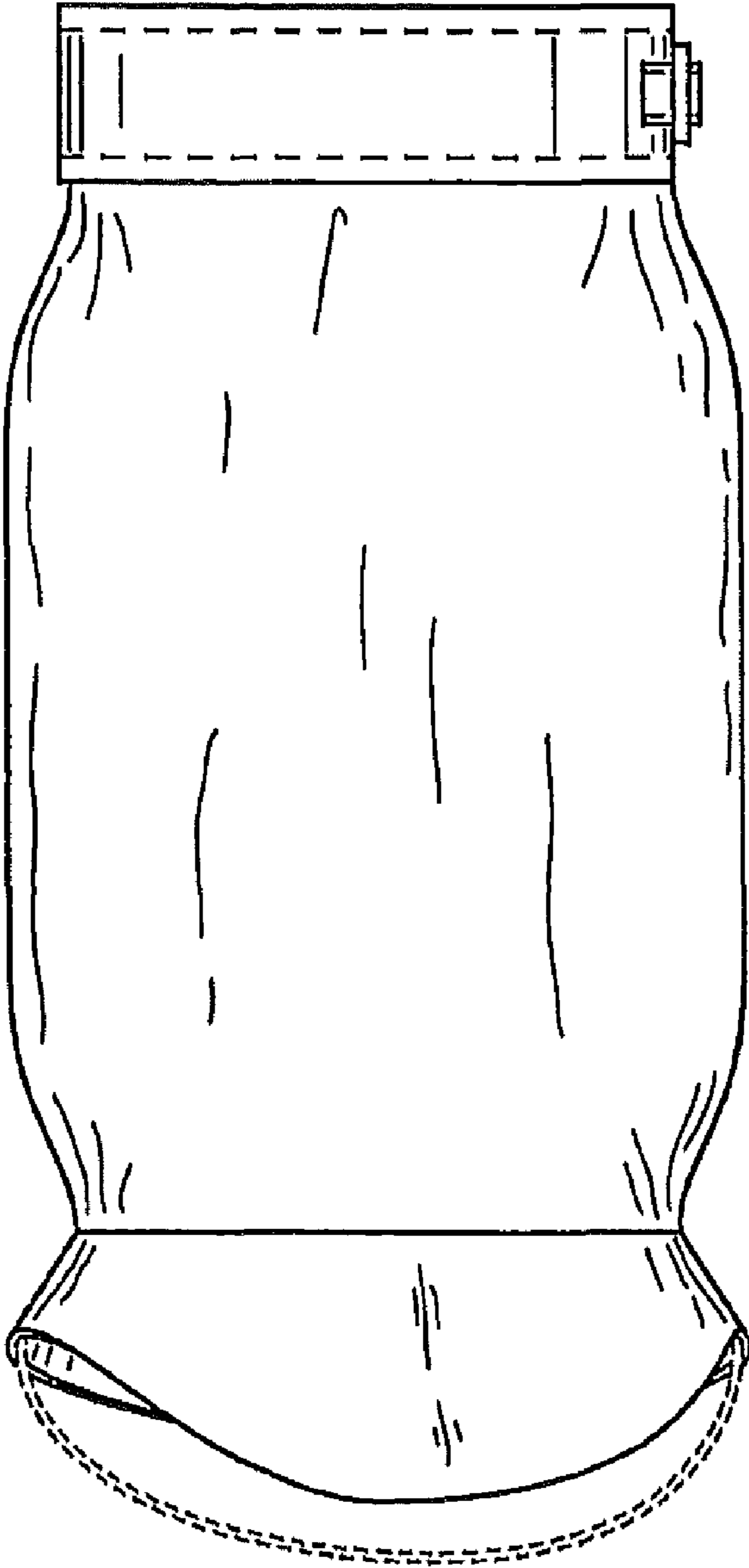

FIG. 5

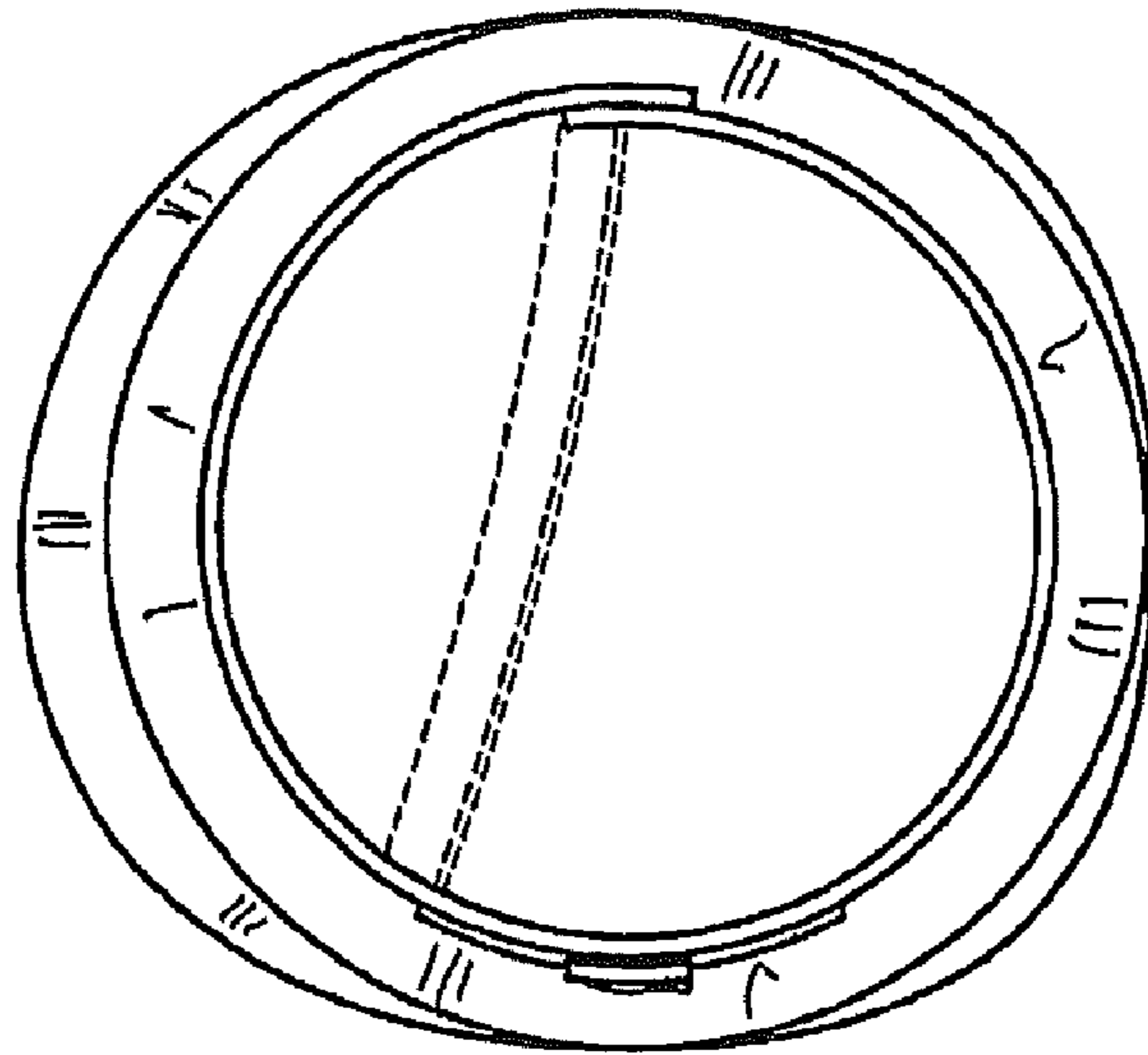

FIG. 6

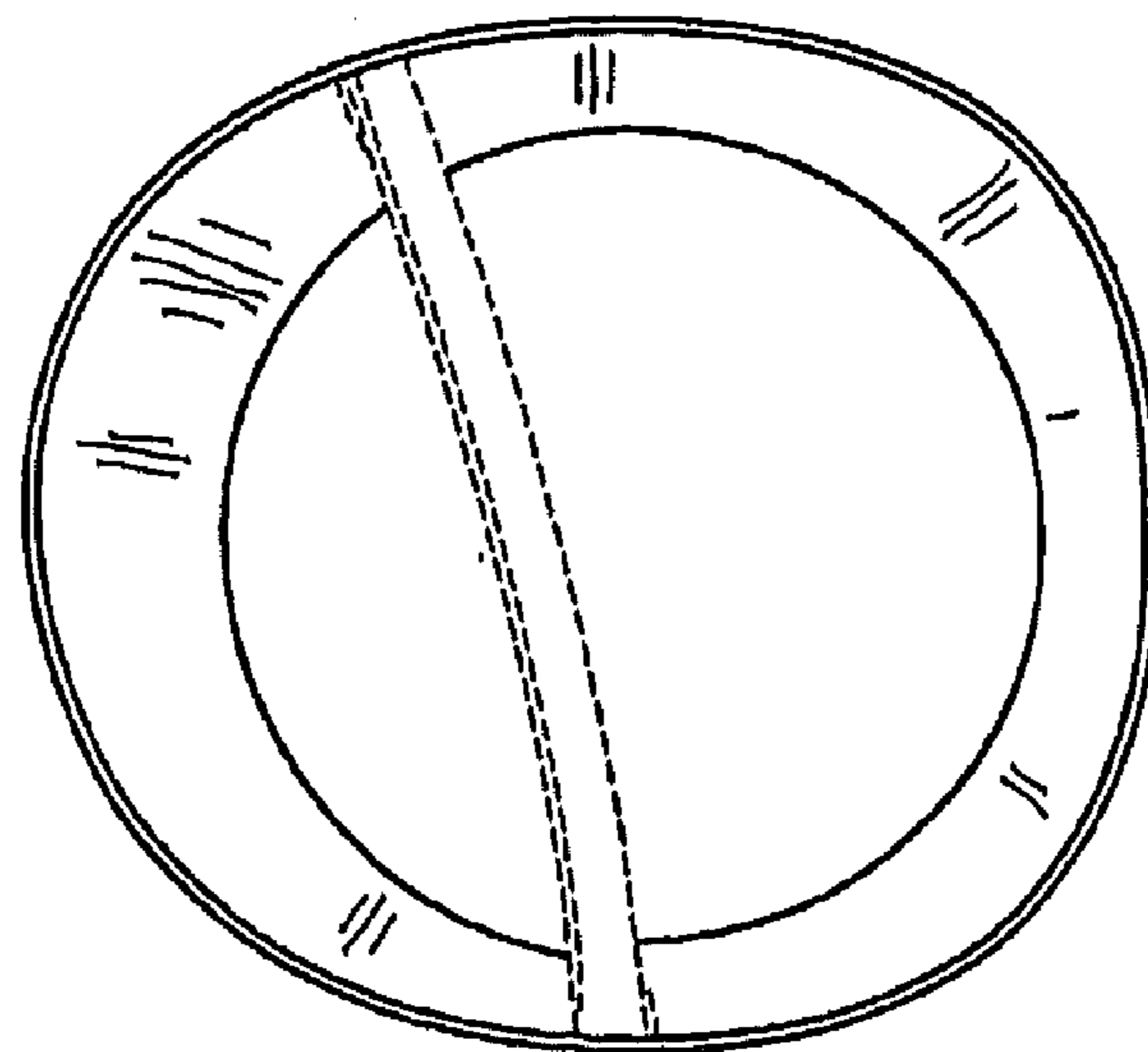

FIG. 7

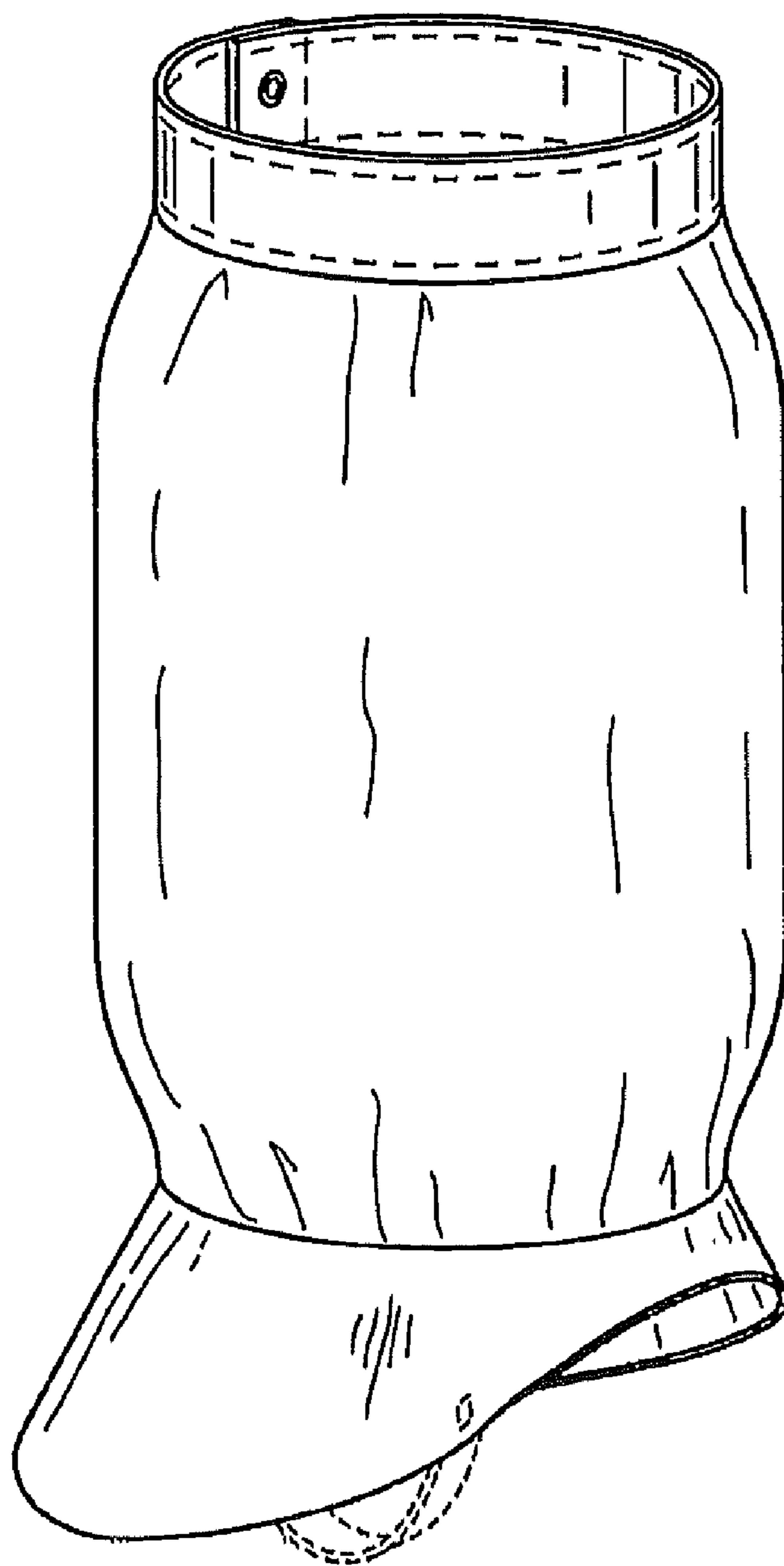

FIG. 8

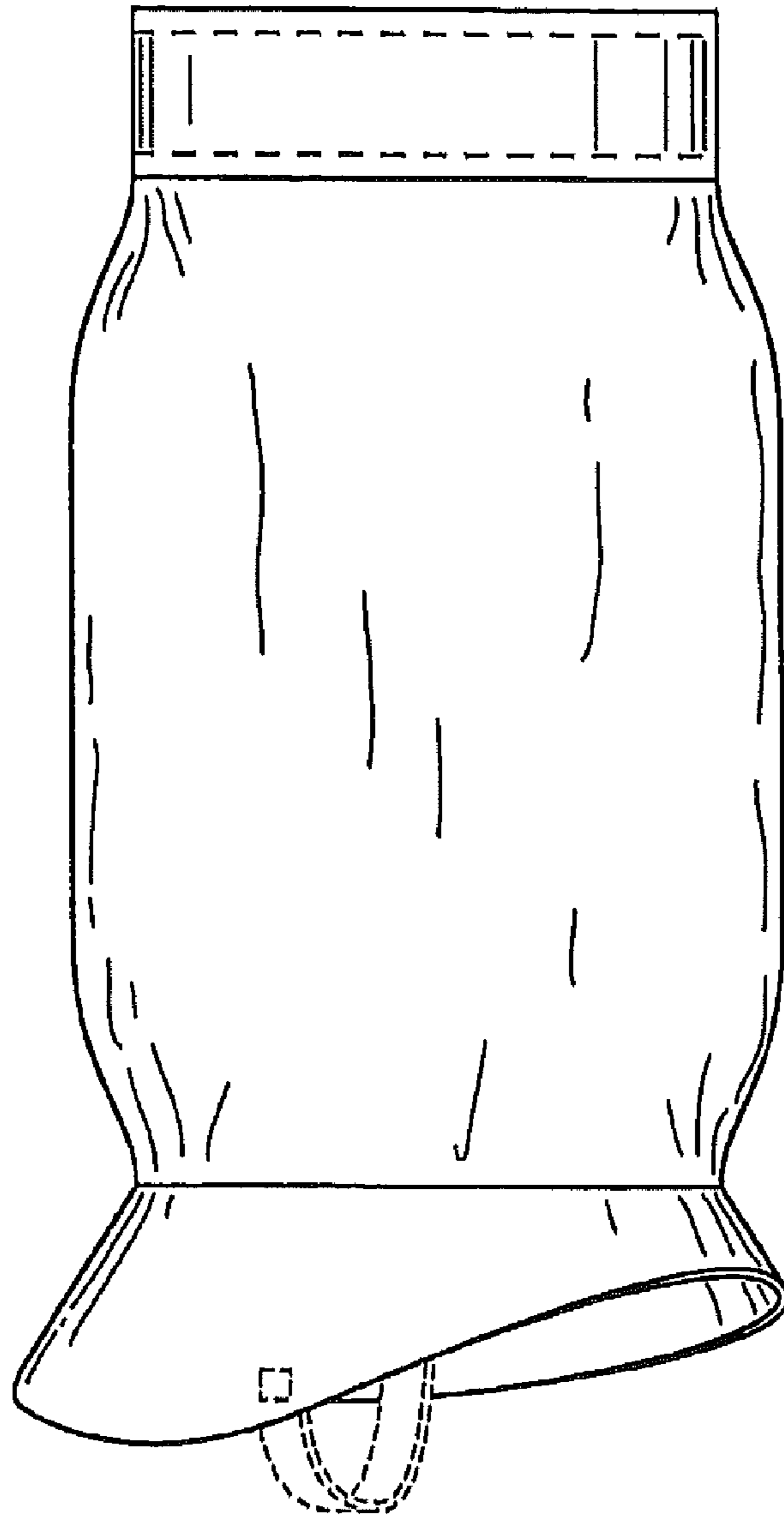

FIG. 9

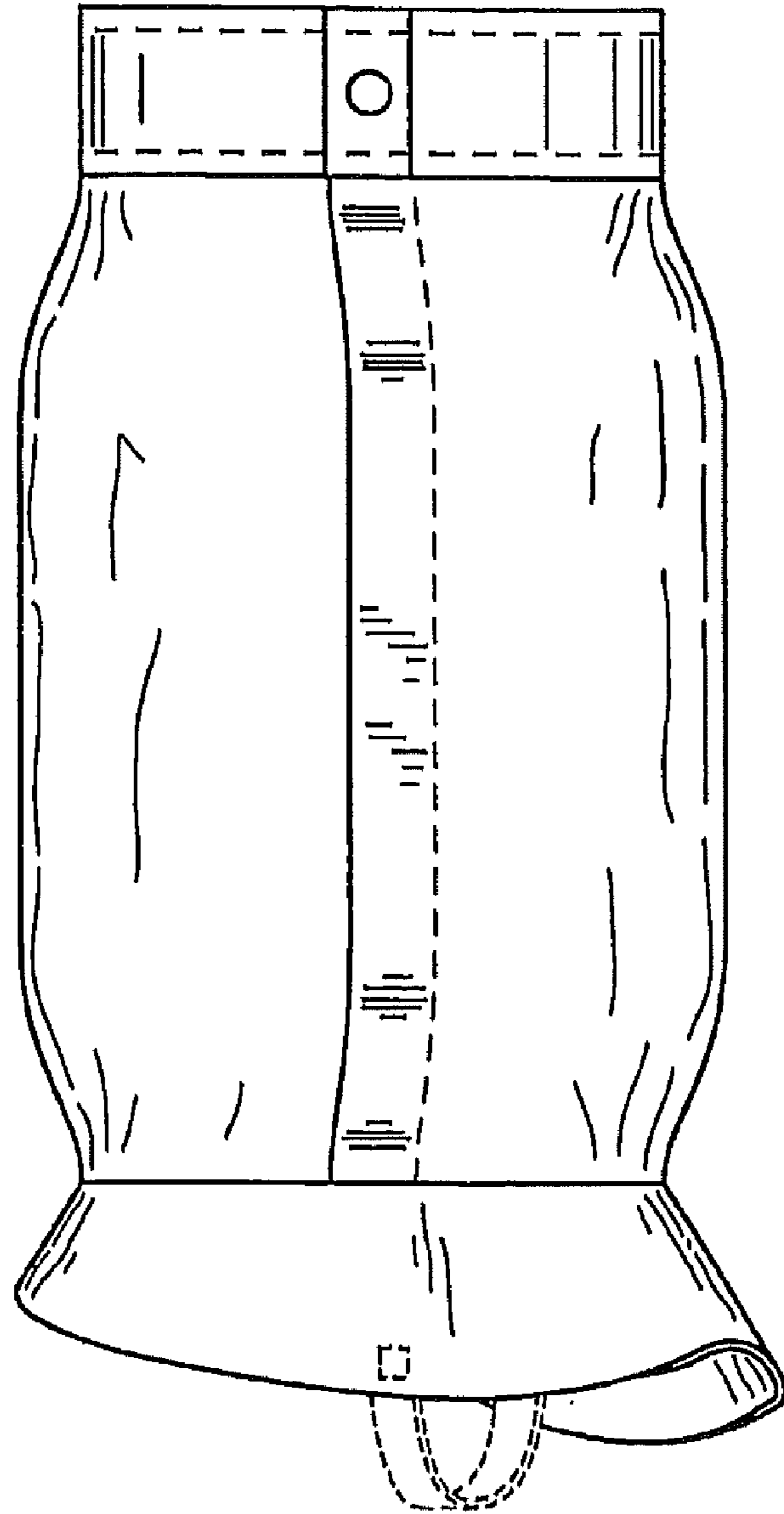

FIG. 10

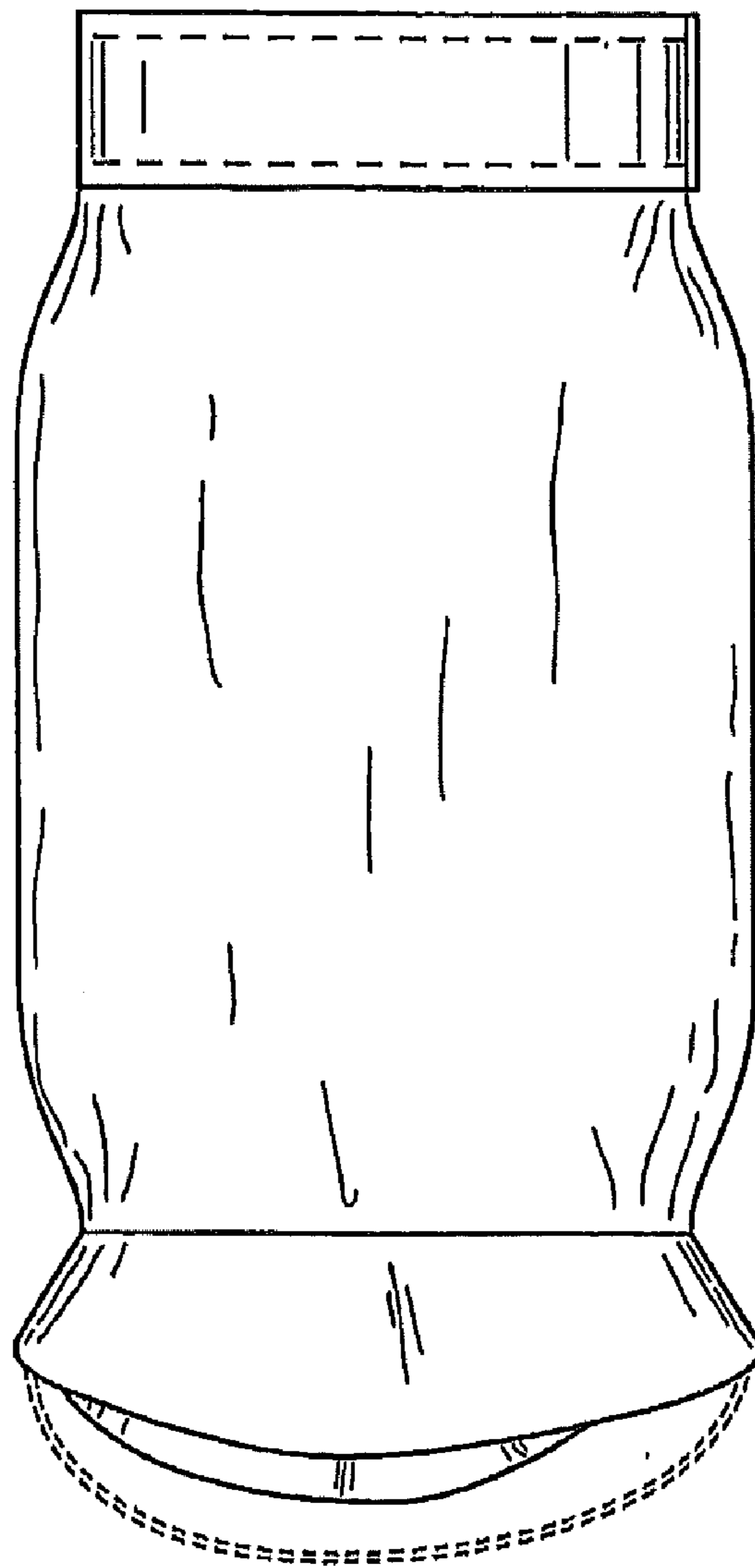

FIG. 11

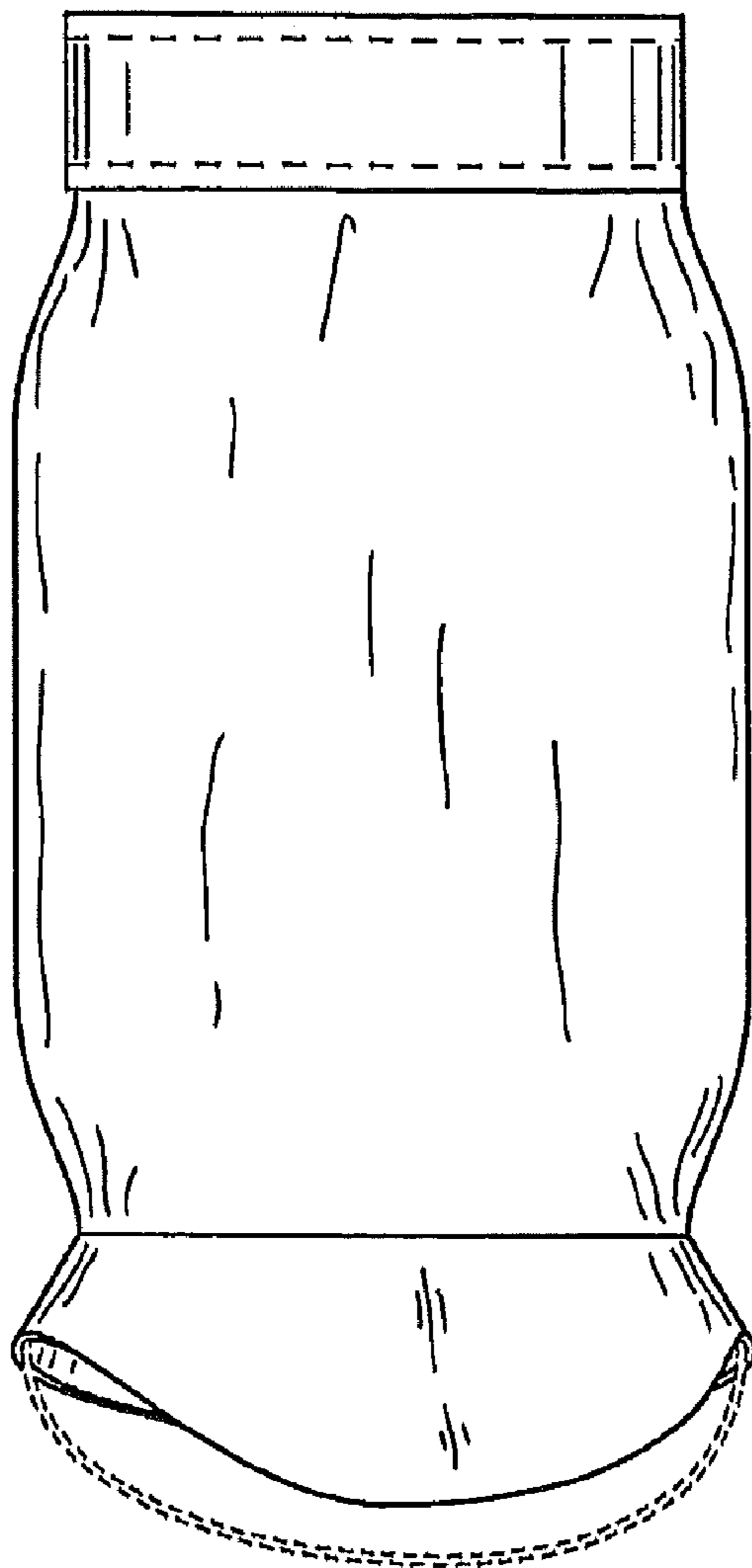

FIG. 12

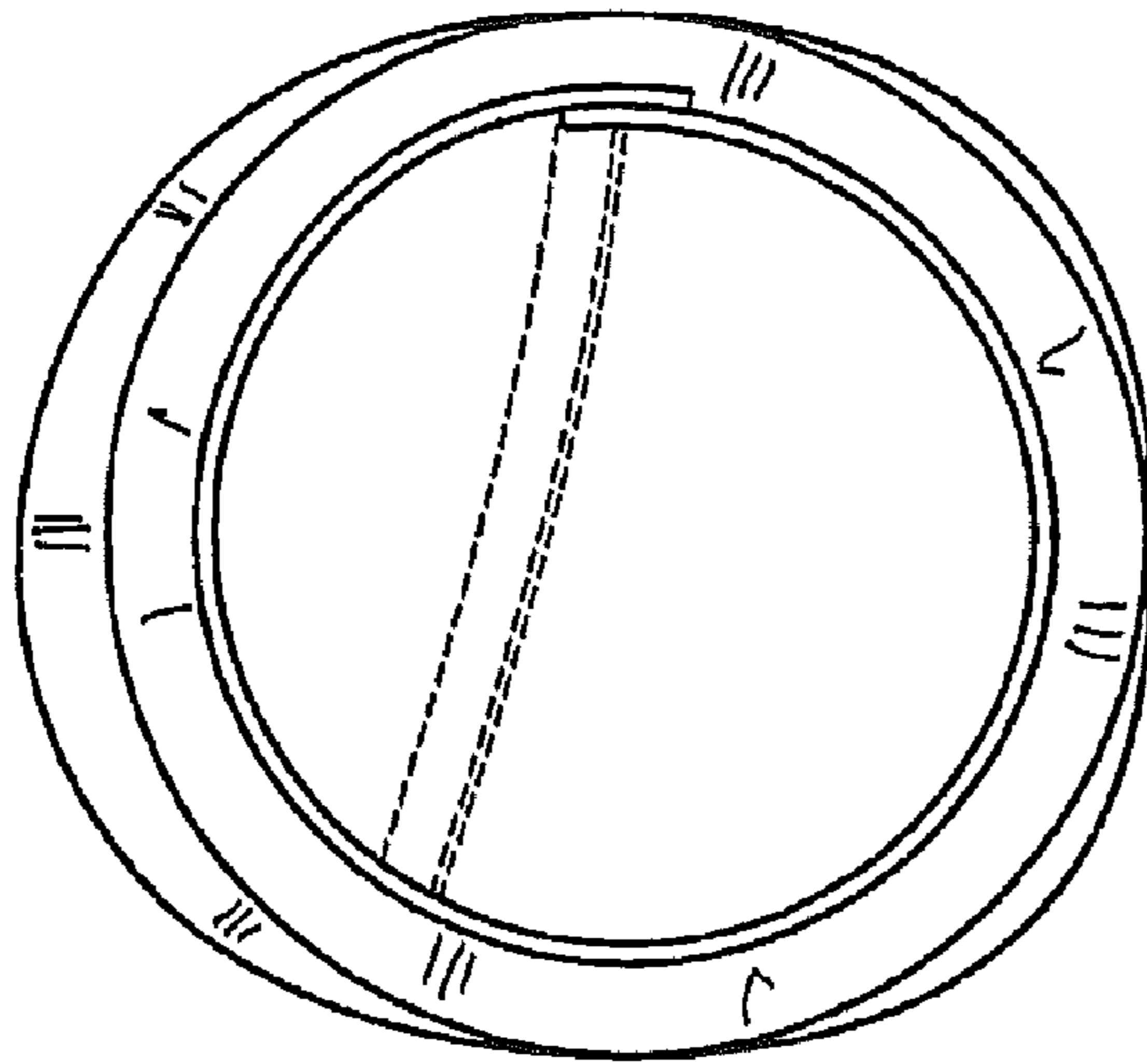

FIG. 13

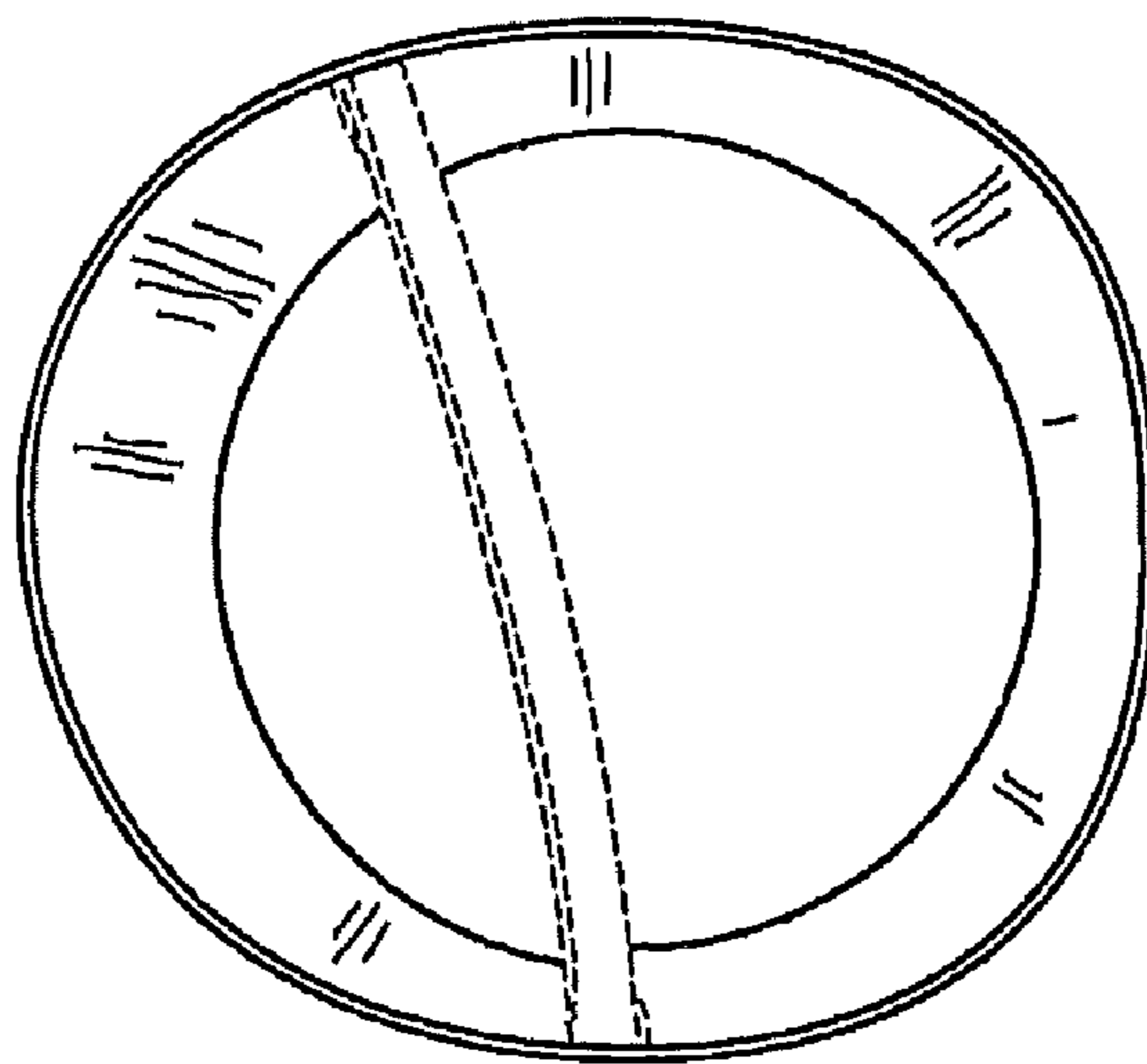

FIG. 14