



US00D659267S

(12) **United States Design Patent**
Slatkin et al.

(10) **Patent No.:** **US D659,267 S**

(45) **Date of Patent:** **** May 8, 2012**

(54) **CANDLE JAR WITH CAP**

(74) *Attorney, Agent, or Firm* — Colucci & Umans

(75) Inventors: **Harry Slatkin**, New York, NY (US);
Heidi Valentino, New York, NY (US)

(57) **CLAIM**

The ornamental design for a candle jar with cap, as shown and described.

(73) Assignee: **Bath & Body Works Brand Management, Inc.**, Reynoldsburg, OH (US)

DESCRIPTION

(**) Term: **14 Years**

FIG. 1 is a front, top perspective view of a candle jar with cap showing our new design therefor;

(21) Appl. No.: **29/329,694**

FIG. 2 is a front elevational view thereof, the rear and side elevational views being identical;

(22) Filed: **Dec. 19, 2008**

FIG. 3 is a bottom plan view thereof;

(51) **LOC (9) Cl.** **26-01**

FIG. 4 is a top plan view thereof;

(52) **U.S. Cl.** **D26/22**

FIG. 5 is a view similar to FIG. 1 of another embodiment of the invention;

(58) **Field of Classification Search** D26/6–23;
431/289, 291, 292, 295, 350; D7/598, 509,
D7/745; D11/143; D9/500, 503–505, 432,
D9/516, 551, 538, 509

FIG. 6 is a front elevational view thereof, the rear and side elevational views being identical;

See application file for complete search history.

FIG. 7 is a bottom plan view thereof;

FIG. 8 is a top plan view thereof;

FIG. 9 is a view similar to FIG. 1 of a still further embodiment of the candle jar with cap;

(56) **References Cited**

U.S. PATENT DOCUMENTS

D29,968 S *	1/1899	Ragsdale	D9/504
D249,998 S *	10/1978	Gobleck, Jr.	D7/613
D442,301 S *	5/2001	Klett et al.	D26/7
D443,083 S *	5/2001	Dearth	D26/10
D586,228 S *	2/2009	McWillis	D9/633
2009/0170046 A1 *	7/2009	Wooten	431/289

FIG. 10 is a front elevational view thereof, the rear and side elevational views being identical;

FIG. 11 is a bottom plan view thereof;

FIG. 12 is a top plan view thereof;

FIG. 13 is a view similar to FIG. 1 of another embodiment of the invention;

FIG. 14 is a front elevational view thereof, the rear and side elevational views being identical;

FIG. 15 is a bottom plan view thereof; and,

FIG. 16 is a top plan view thereof.

* cited by examiner

Primary Examiner — T. Chase Nelson

Assistant Examiner — Ania Aman

1 Claim, 12 Drawing Sheets

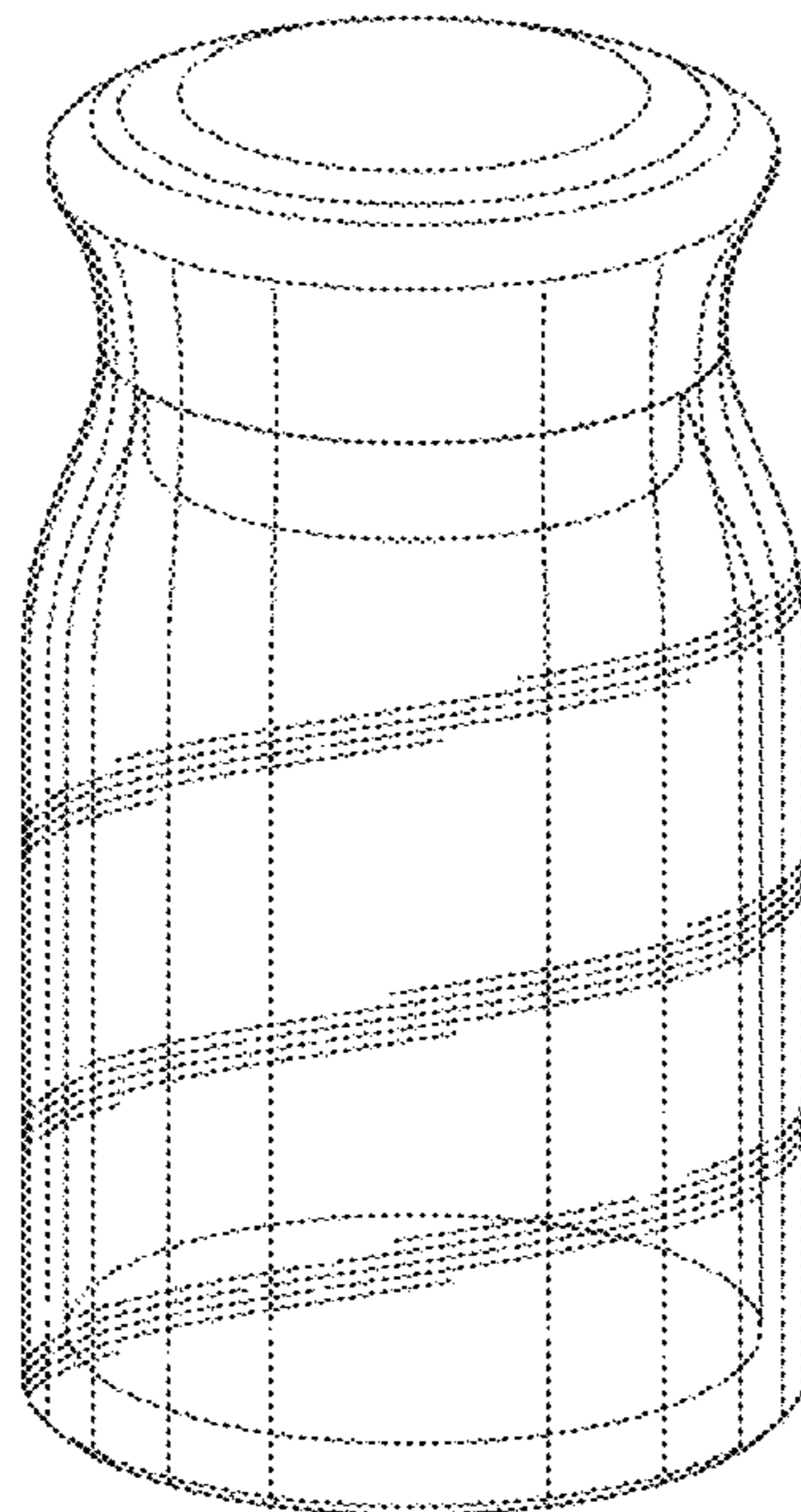

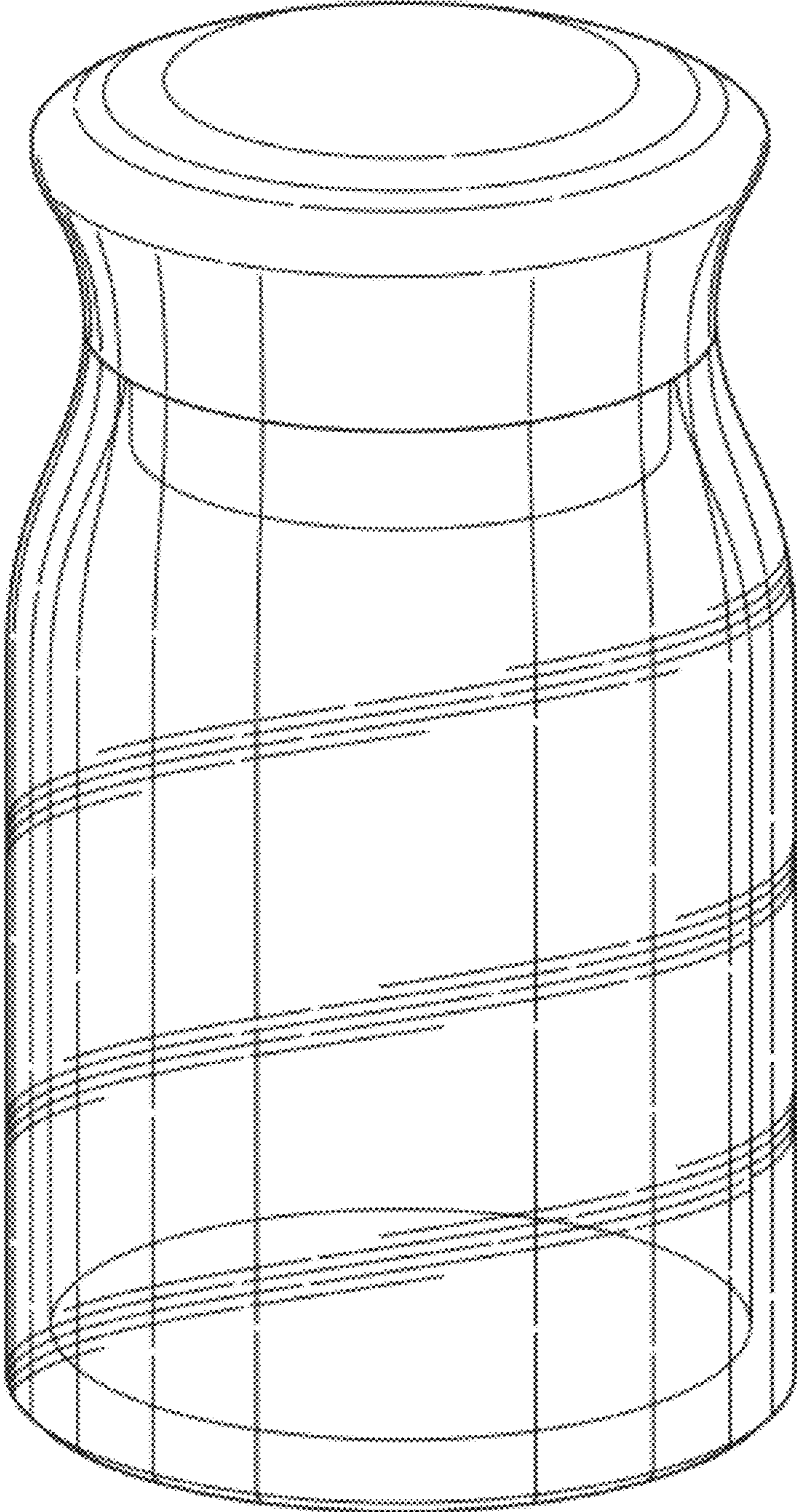

FIG. 1

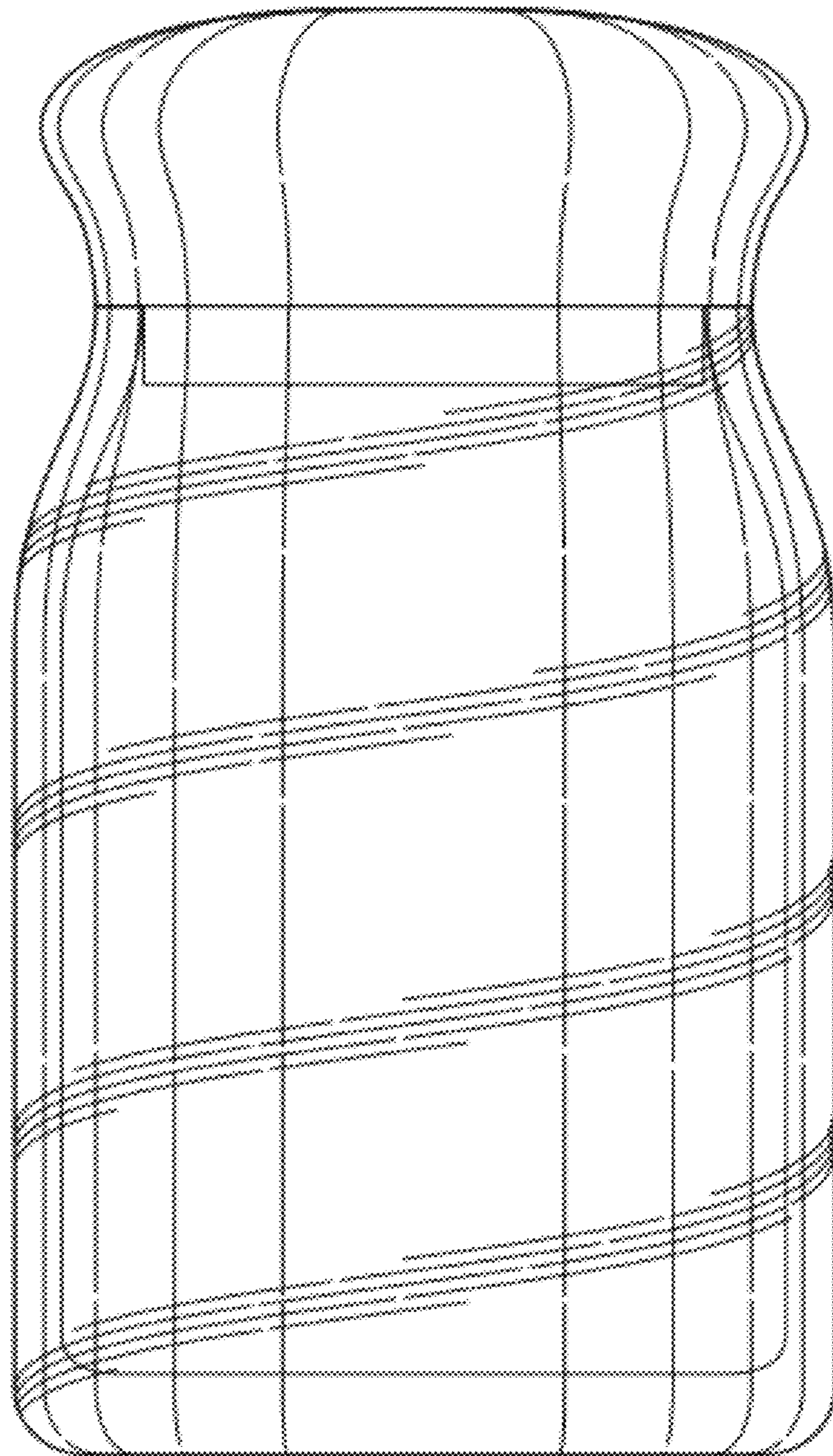

FIG. 2

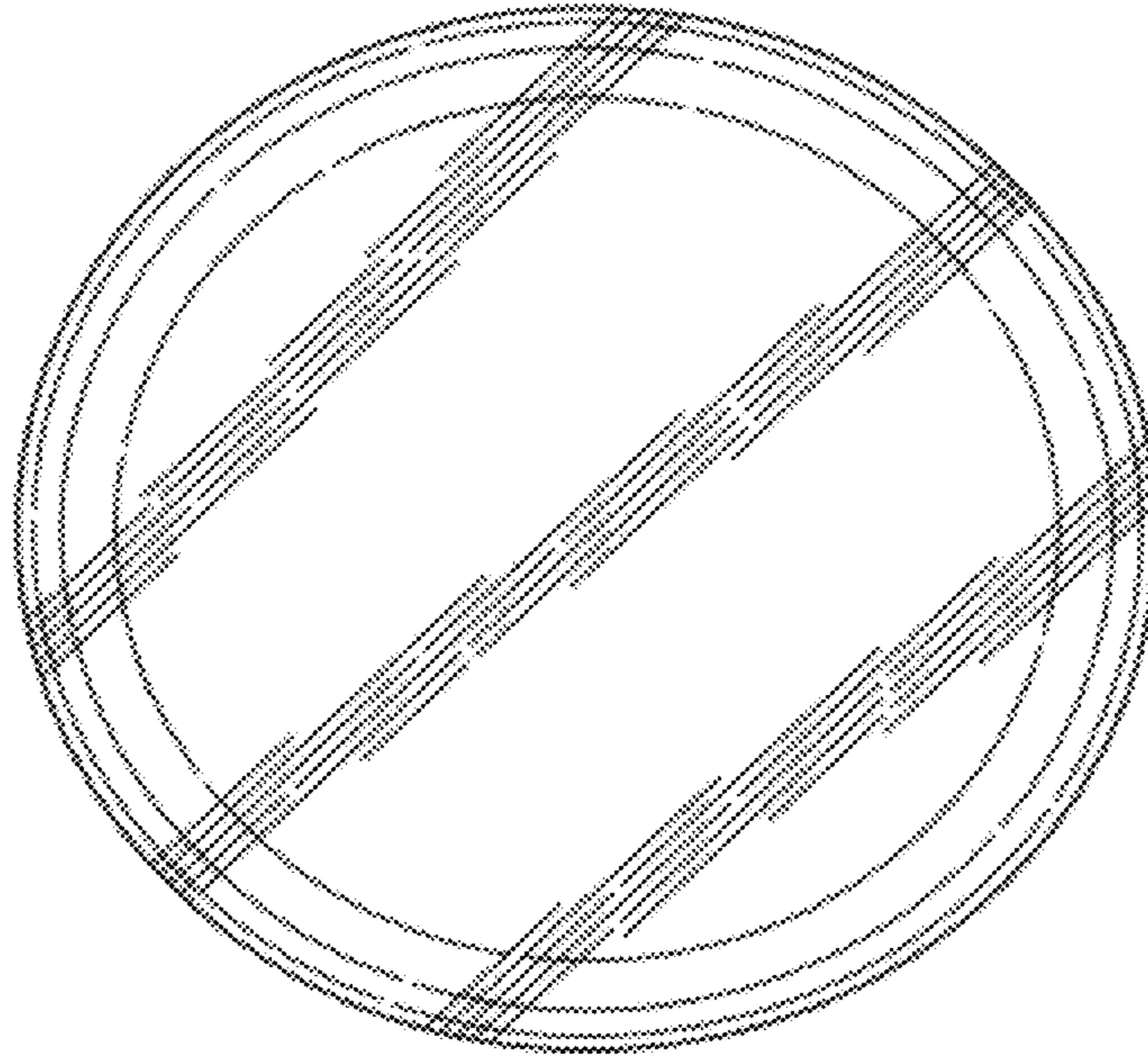

FIG. 3

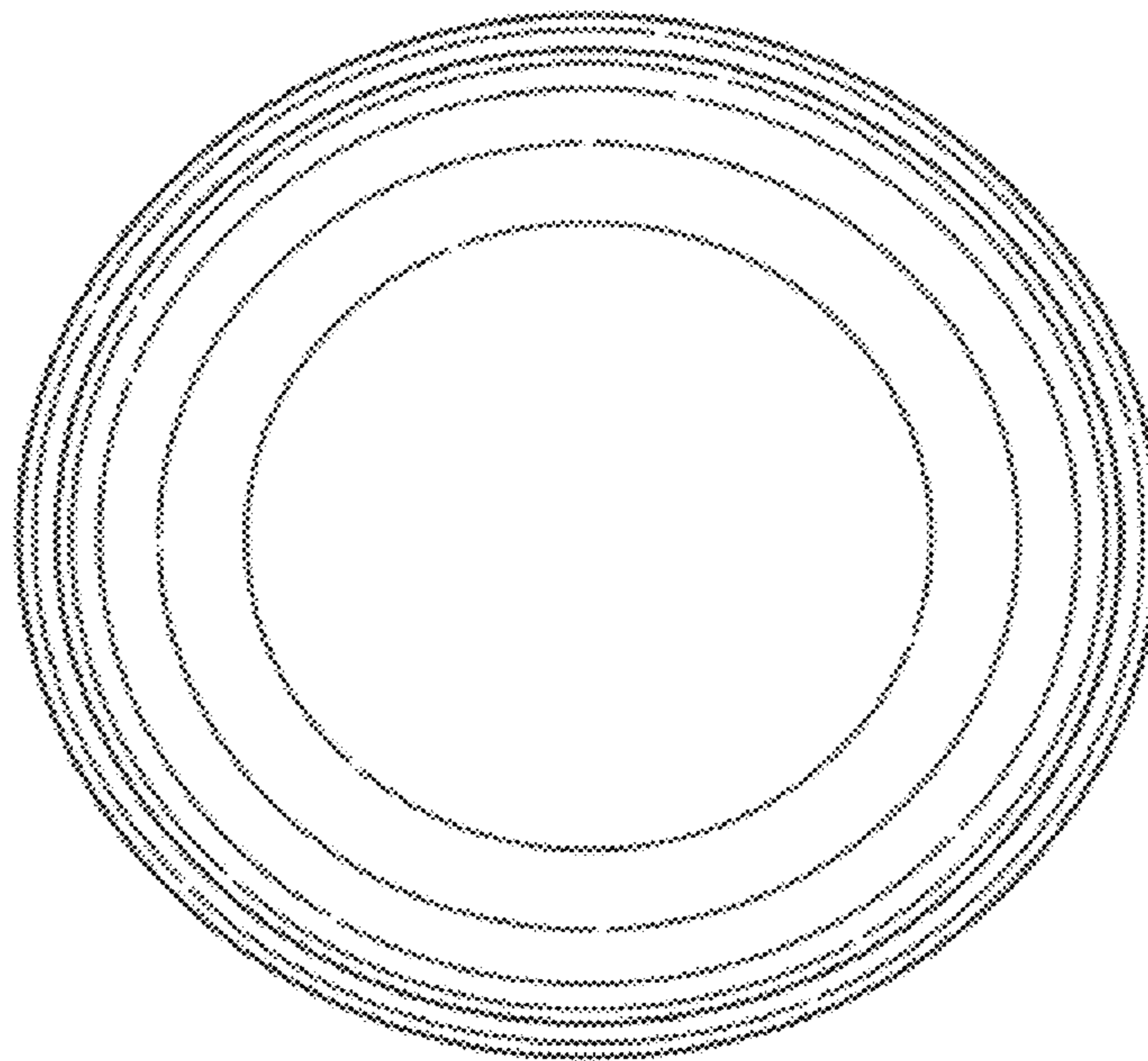

FIG. 4

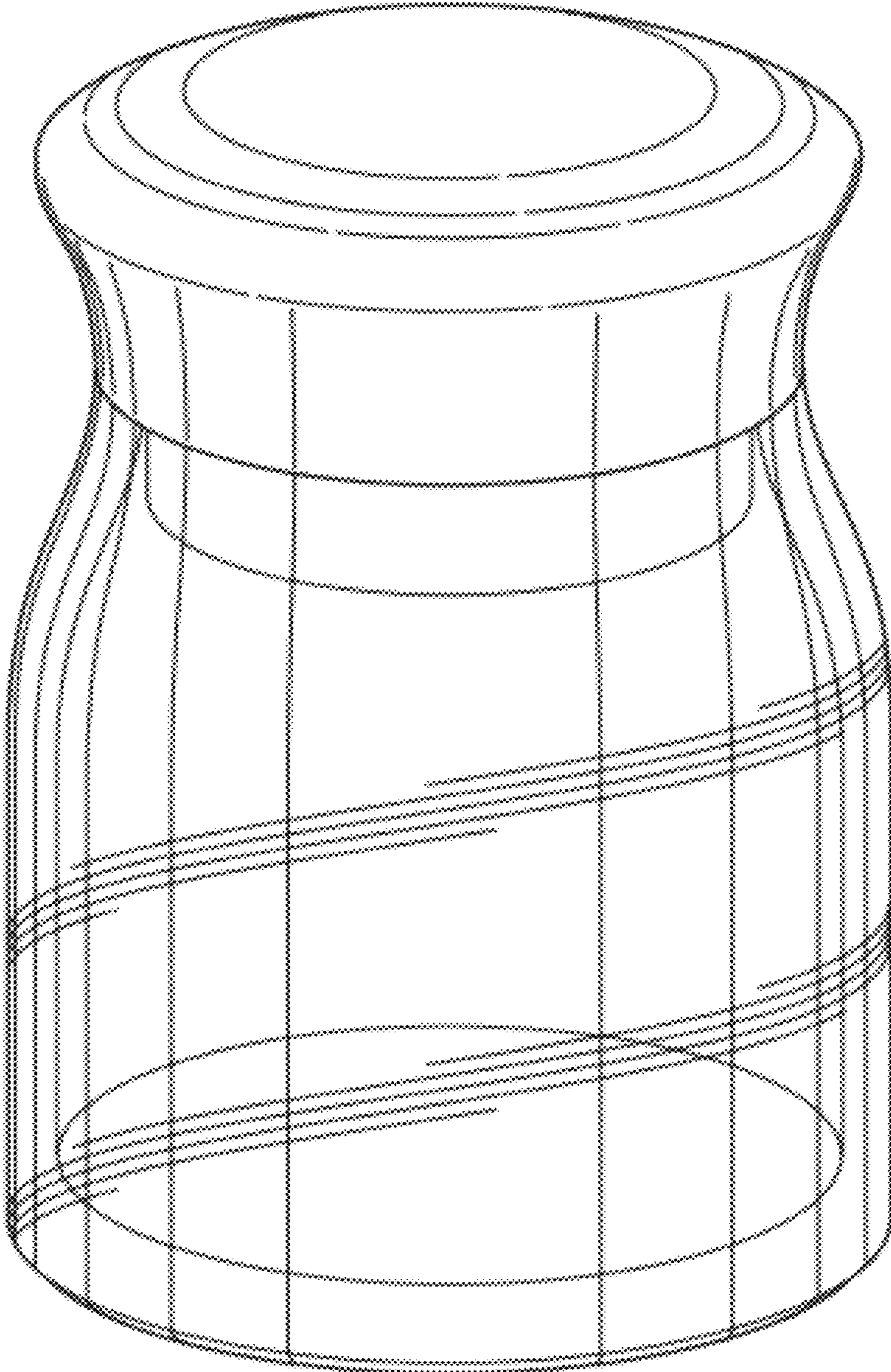

FIG. 5

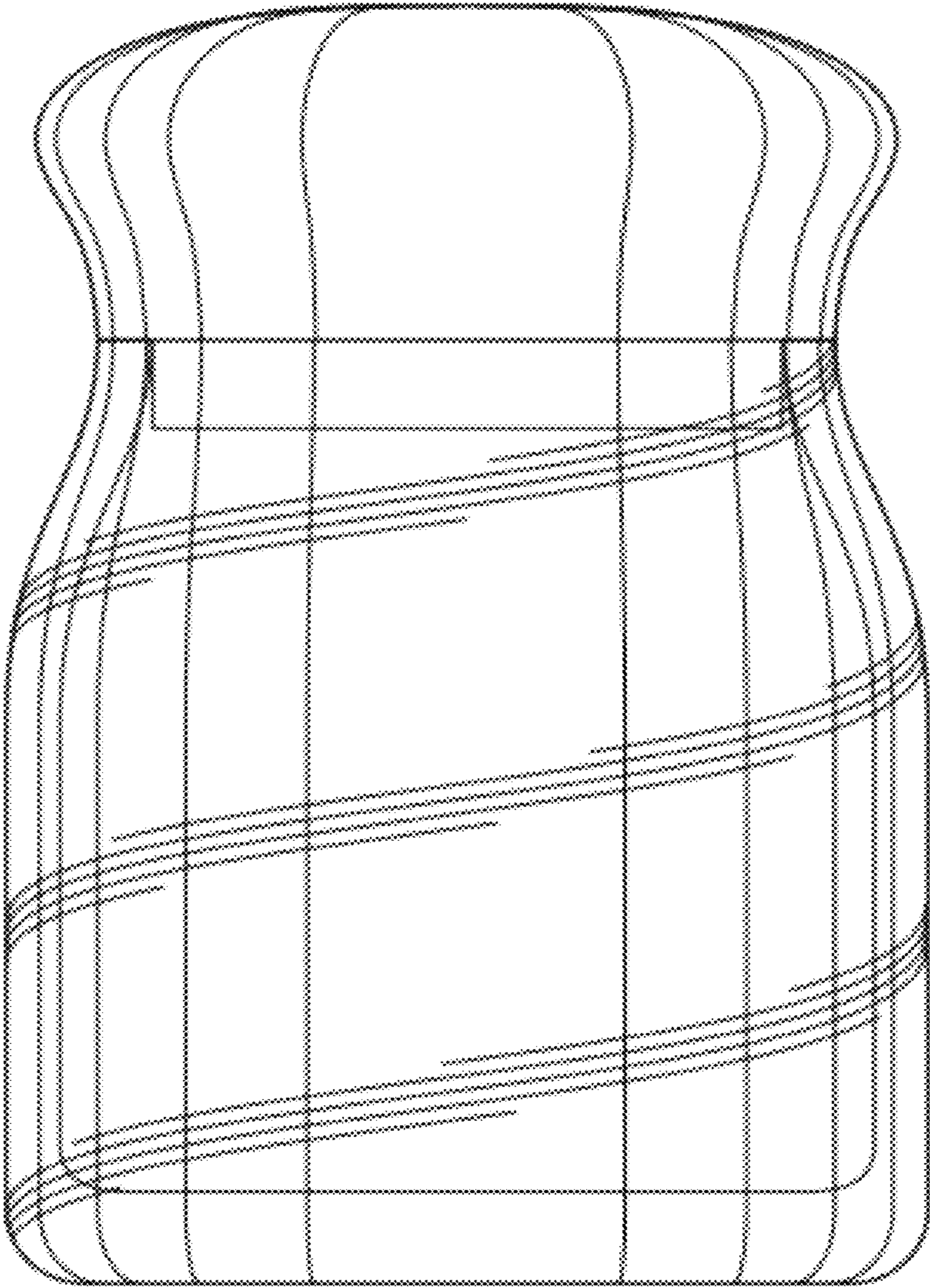

FIG. 6

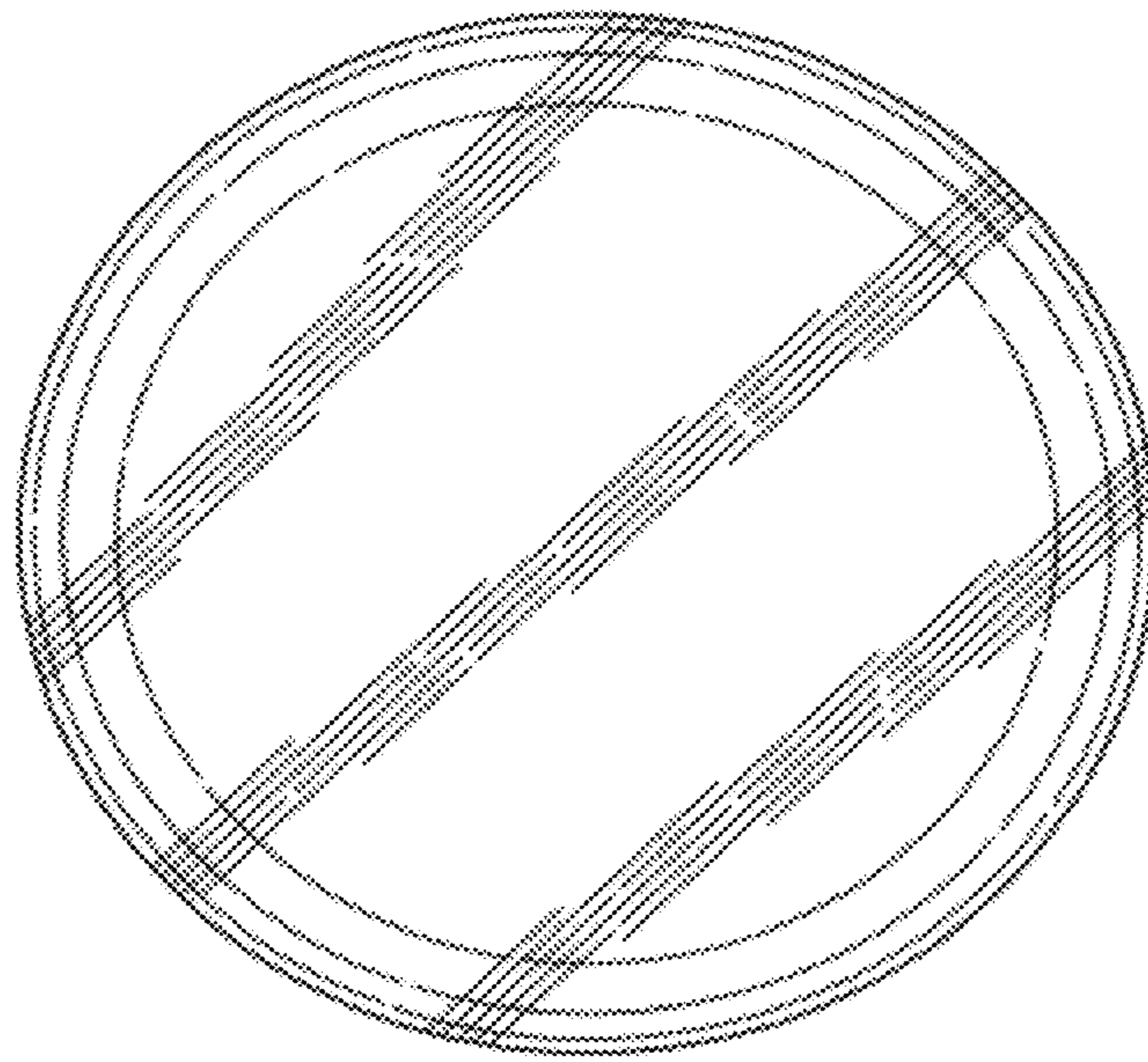

FIG. 7

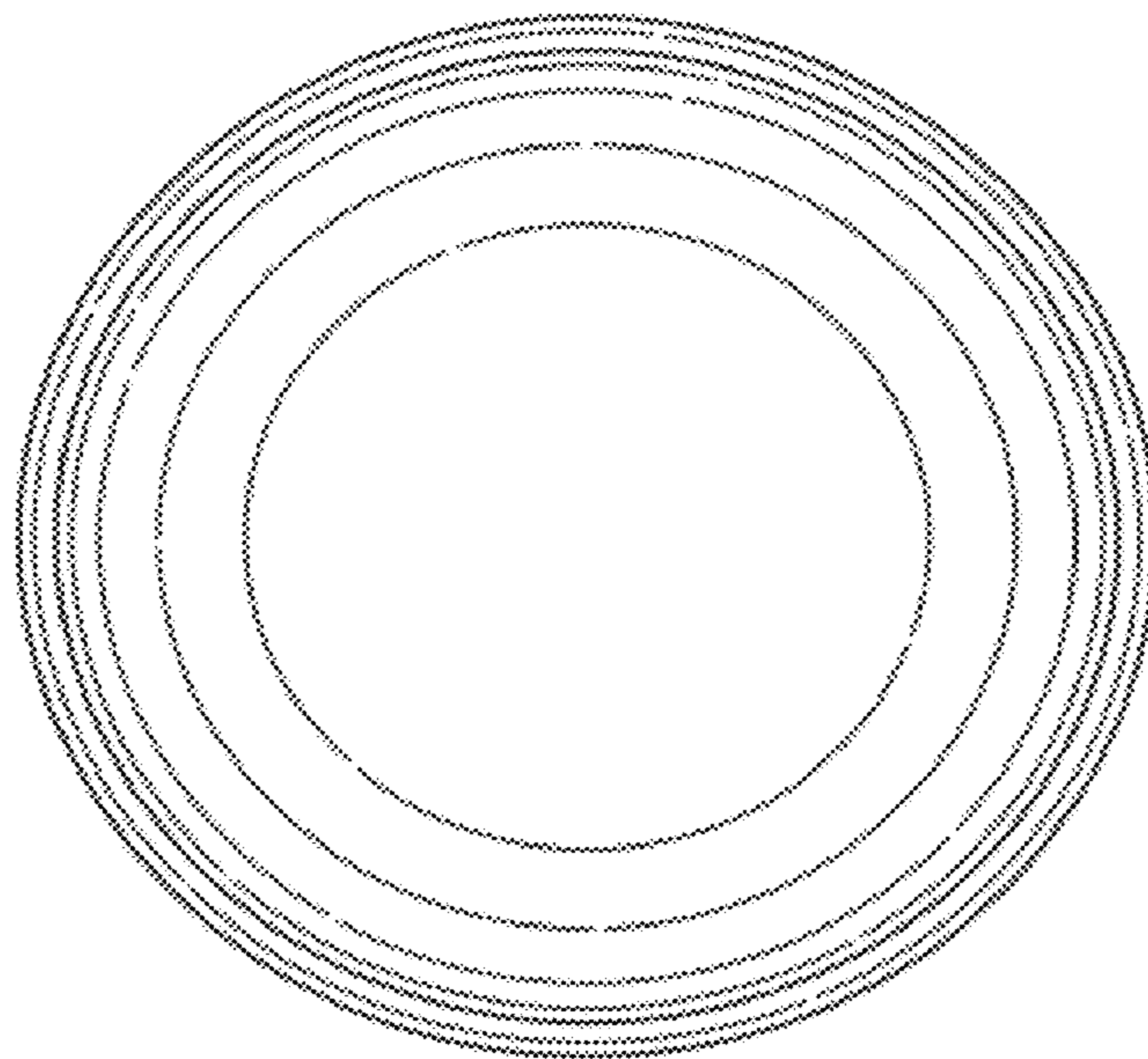

FIG. 8

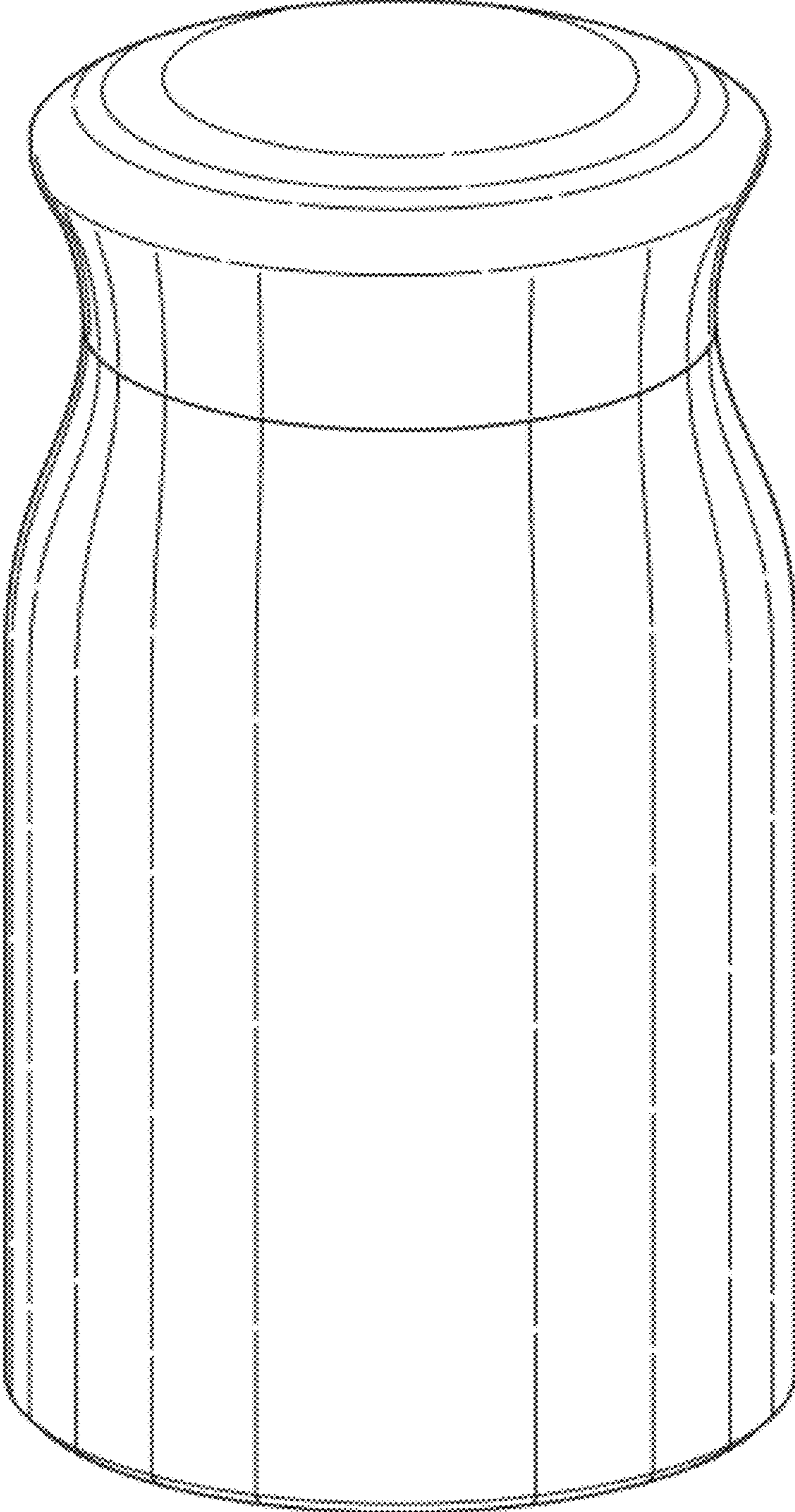

FIG. 9

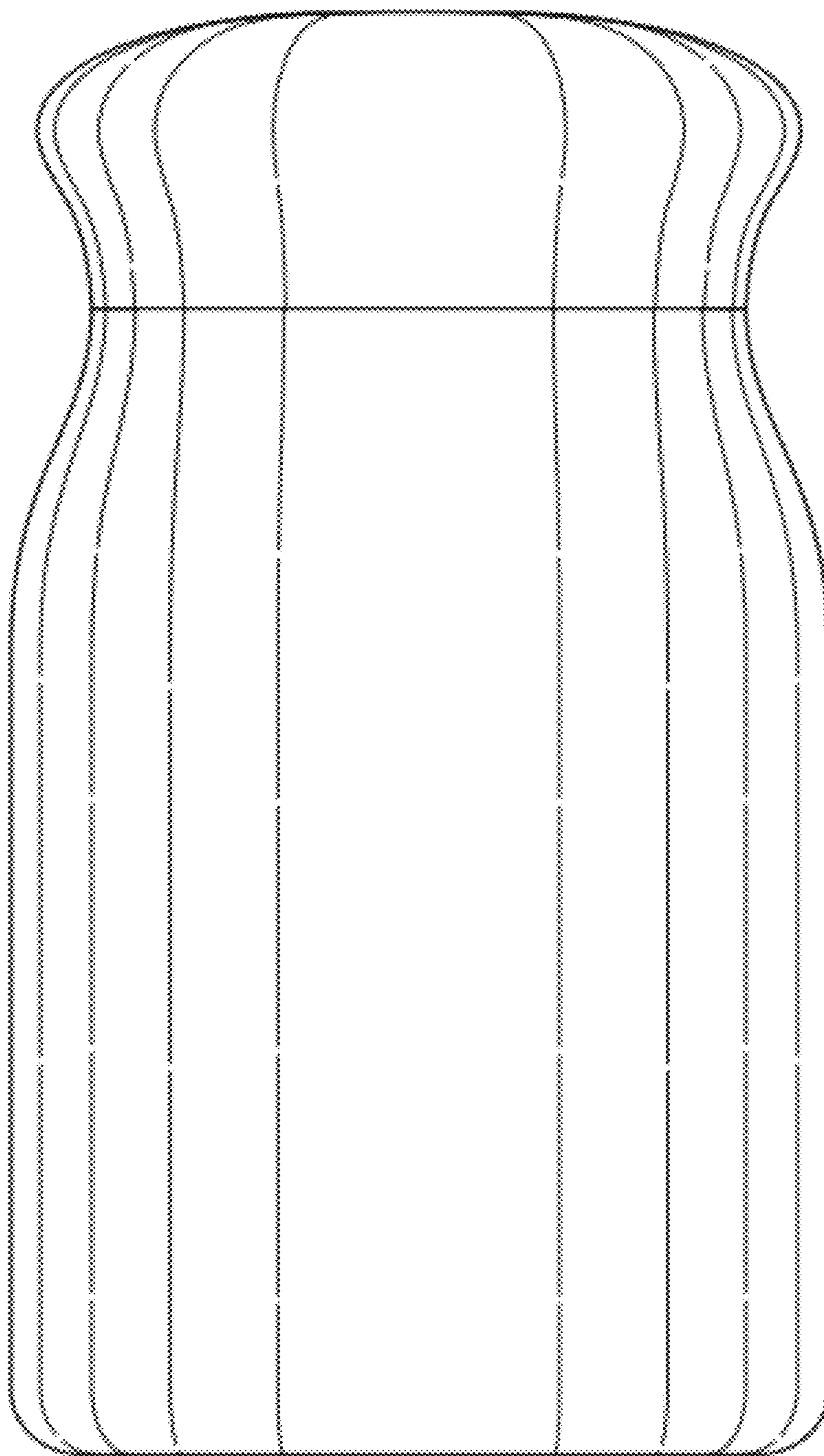

FIG. 10

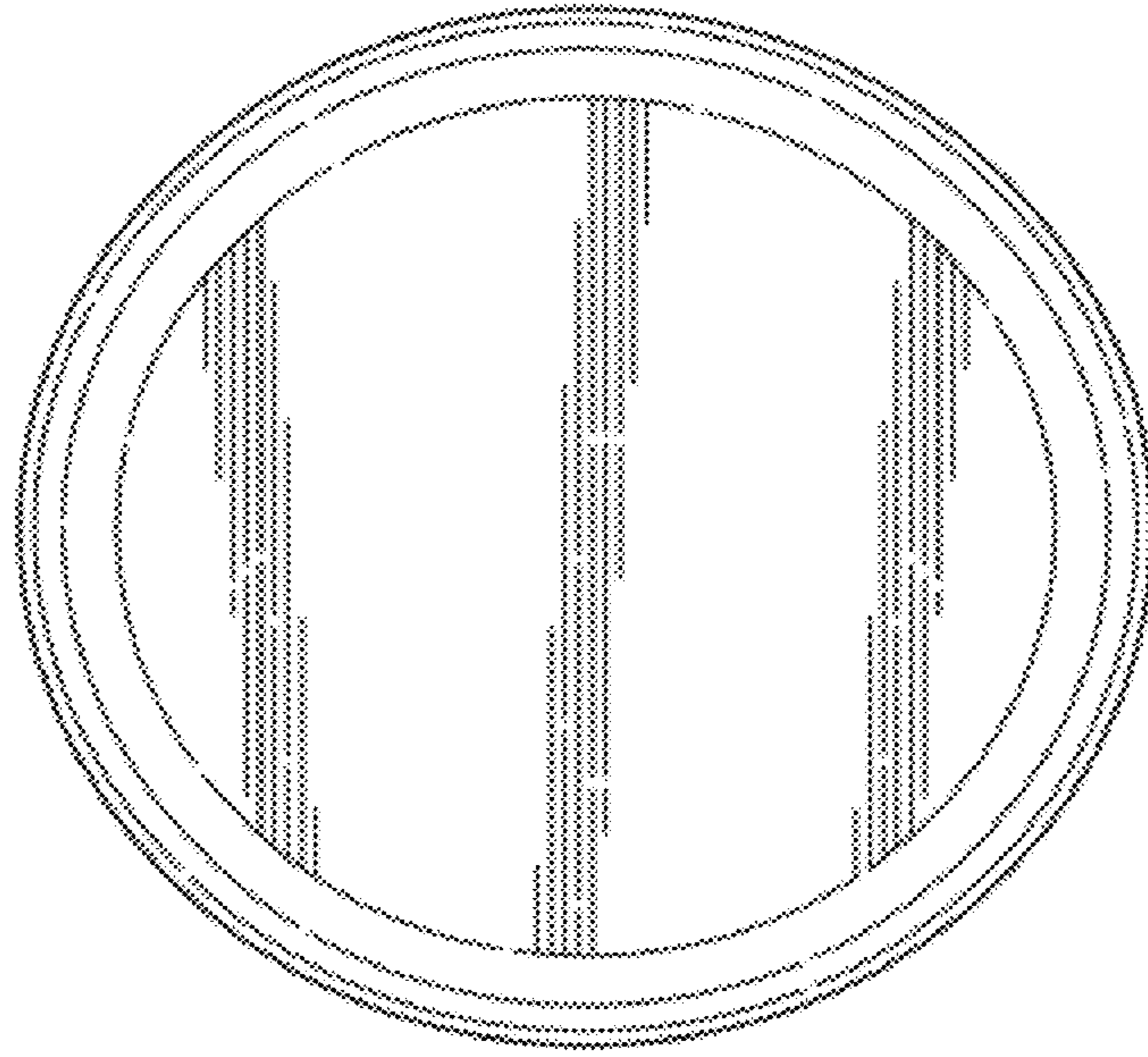

FIG. 11

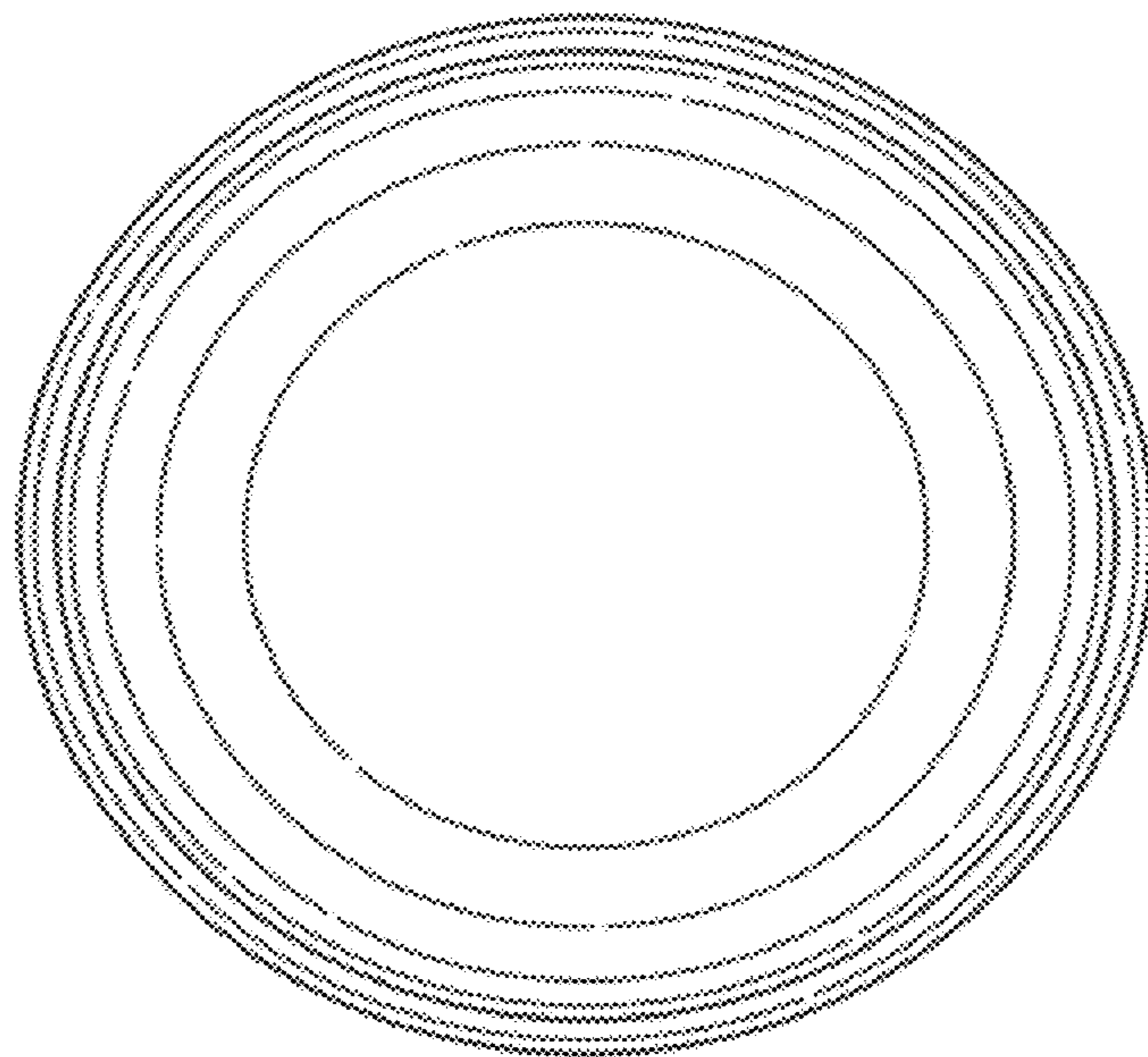

FIG. 12

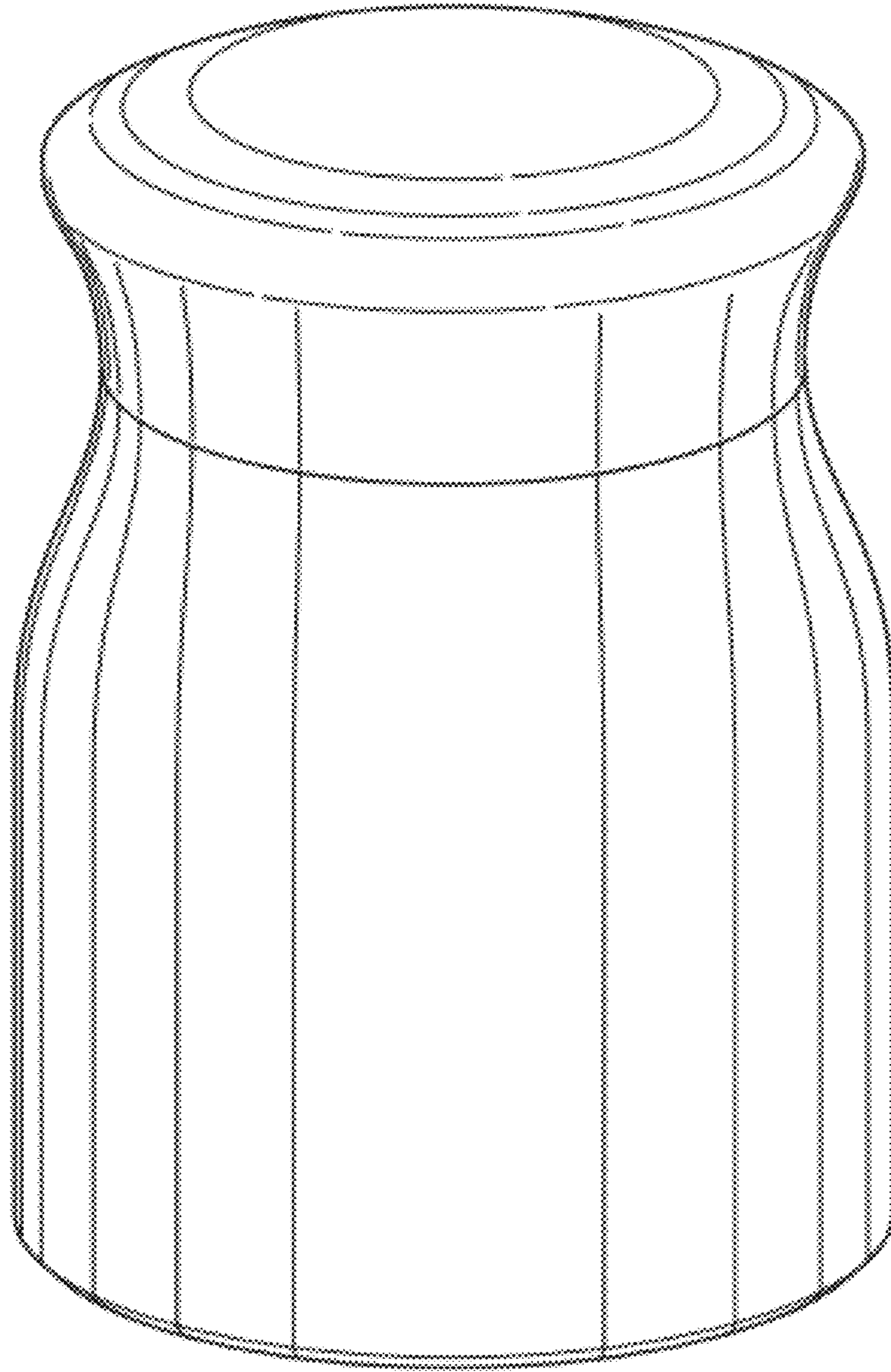

FIG. 13

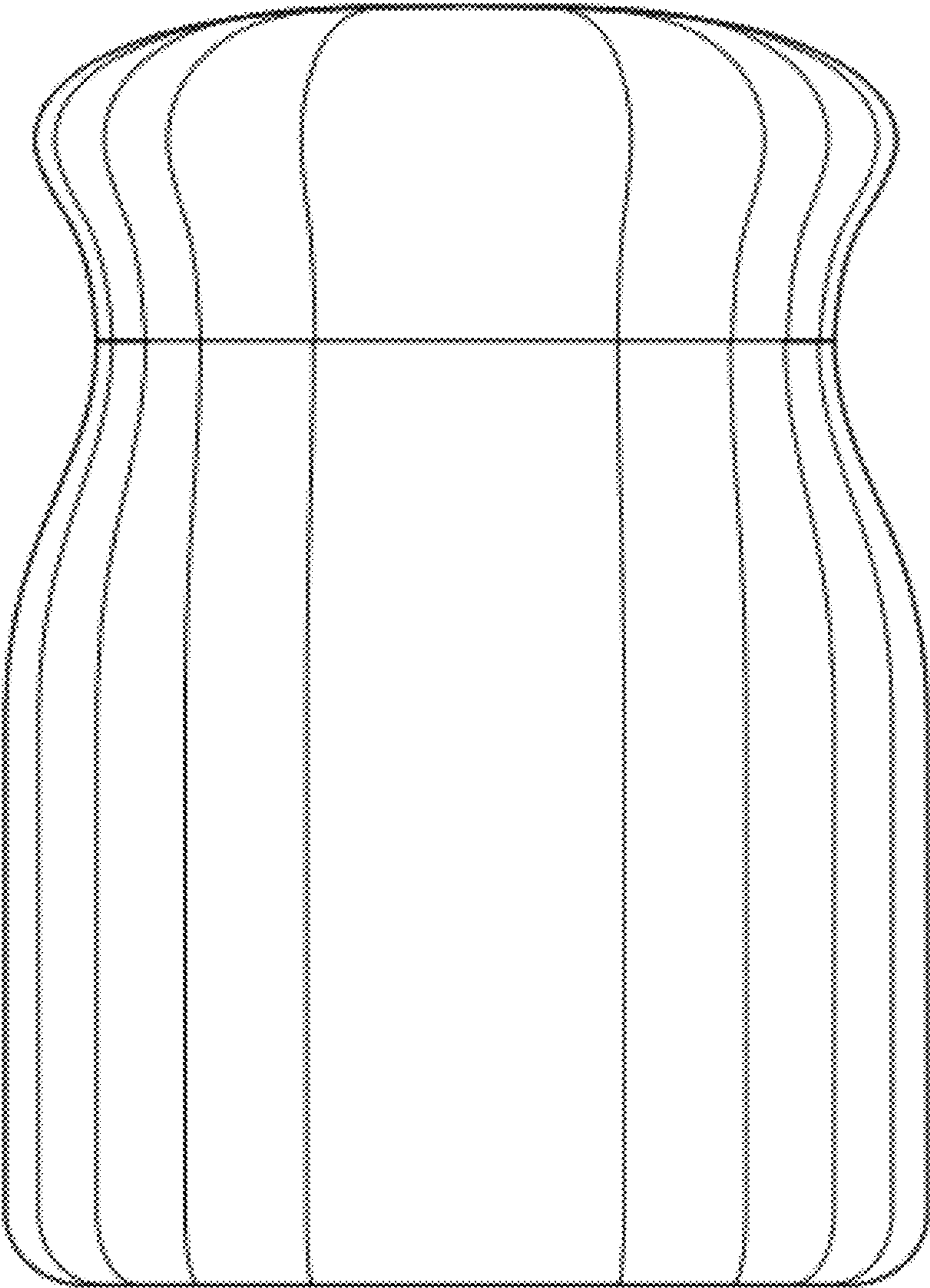

FIG. 14

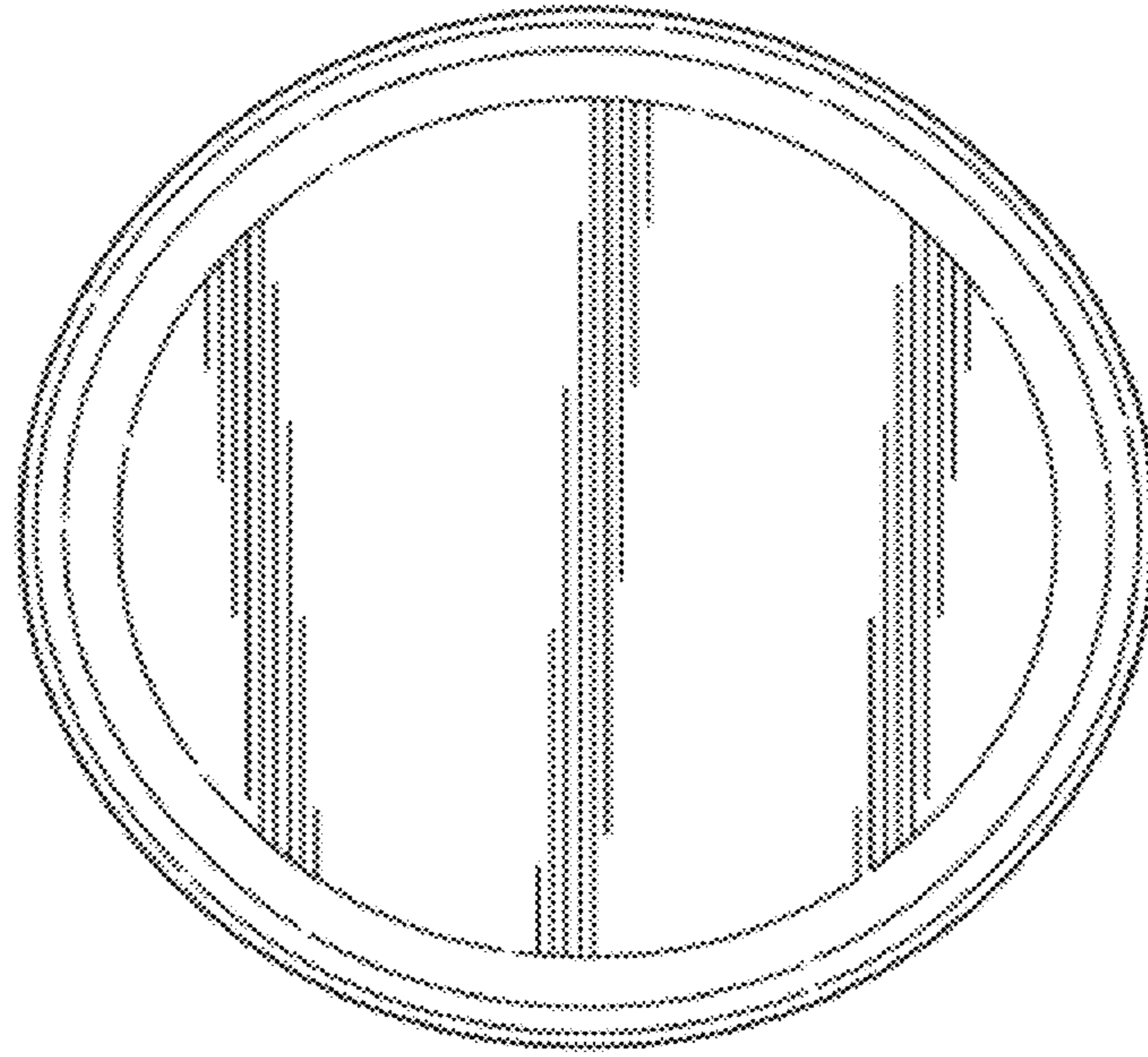

FIG. 15

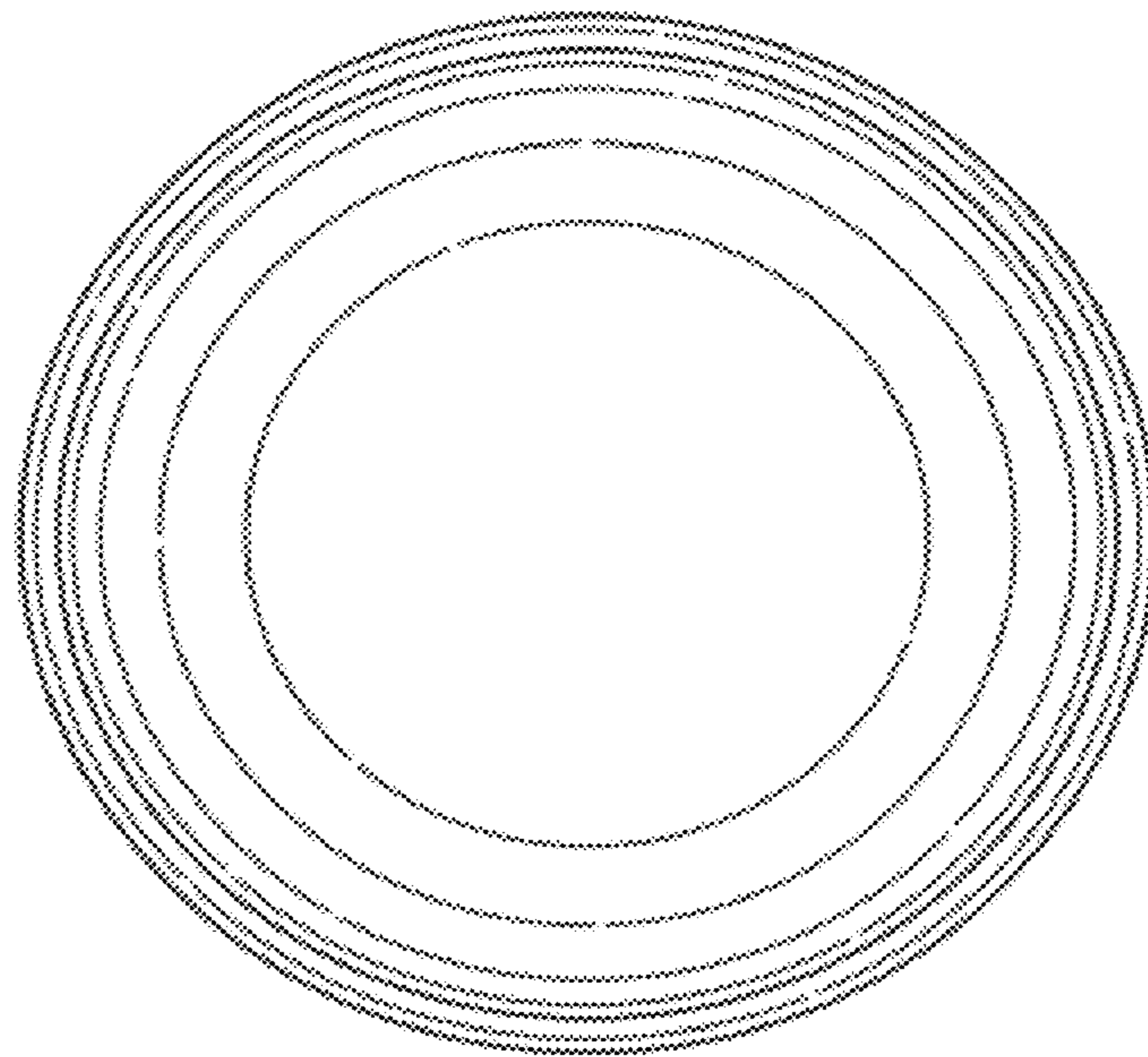

FIG. 16