

US00D659059S

(12) **United States Design Patent**  
**Elmitt**

(10) **Patent No.:** **US D659,059 S**  
(45) **Date of Patent:** **\*\* May 8, 2012**

(54) **DECORATIVE ELEMENT FOR A VEHICLE**

(75) Inventor: **Karl-Johann Elmitt**, Eching (DE)

(73) Assignee: **Bayerische Motoren Werke Aktiengesellschaft**, Munich (DE)

(\*\*) Term: **14 Years**

(21) Appl. No.: **29/396,239**

(22) Filed: **Jun. 28, 2011**

(51) **LOC (9) Cl.** ..... **23-08**

(52) **U.S. Cl.** ..... **D12/190**

(58) **Field of Classification Search** ..... D12/190,  
D12/400, 90, 91, 92, 199, 197, 86, 171, 169,  
D12/163, 110, 114; D11/211, 81, 157, 133,  
D11/172; D20/11, 23, 24, 25, 30, 31, 32;  
293/102, 115; 40/413, 591, 592; 428/31

See application file for complete search history.

(56) **References Cited**

**U.S. PATENT DOCUMENTS**

D379,170	S	*	5/1997	Moore et al.	.....	D12/190
D400,839	S	*	11/1998	Moore et al.	.....	D12/190
D403,998	S	*	1/1999	Hutzel et al.	.....	D12/190
D447,459	S	*	9/2001	Oh	.....	D12/196
D540,228	S	*	4/2007	Lai	.....	D12/190
D545,258	S	*	6/2007	Teng	.....	D12/190
D566,022	S	*	4/2008	Johnson	.....	D12/190
D608,262	S	*	1/2010	Truebsbach	.....	D12/190
D609,149	S	*	2/2010	Larson et al.	.....	D12/181
D630,143	S	*	1/2011	Stahel et al.	.....	D12/195
D631,806	S	*	2/2011	Schneider	.....	D12/190
D631,807	S	*	2/2011	Clottu	.....	D12/190
D636,712	S	*	4/2011	Shymkiw	.....	D12/190

**FOREIGN PATENT DOCUMENTS**

EM 001132864-0005 6/2009  
WO DM/068441 1/2007

\* cited by examiner

*Primary Examiner* — Caron D Veynar

*Assistant Examiner* — Katrina A Betton

(74) *Attorney, Agent, or Firm* — Crowell & Moring LLP

(57) **CLAIM**

The ornamental design for a decorative element for a vehicle, as shown and described.

**DESCRIPTION**

FIG. 1 is a left perspective view of a first embodiment of a decorative element for a vehicle according to my design; FIG. 2 is a right perspective view thereof; FIG. 3 is a front view thereof; FIG. 4 is a top view thereof; FIG. 5 is a bottom view thereof; FIG. 6 is a right side view thereof; and FIG. 7 is a left side view thereof. FIG. 8 is a right perspective view of a second embodiment of the decorative element for a vehicle according to my design; FIG. 9 is a left perspective view thereof; FIG. 10 is a front view thereof; FIG. 11 is a top view thereof; FIG. 12 is a bottom view thereof; FIG. 13 is a left side view thereof; and, FIG. 14 is a right side view thereof. The broken lines are for illustrative purposes only and form no part of the claimed design.

**1 Claim, 6 Drawing Sheets**

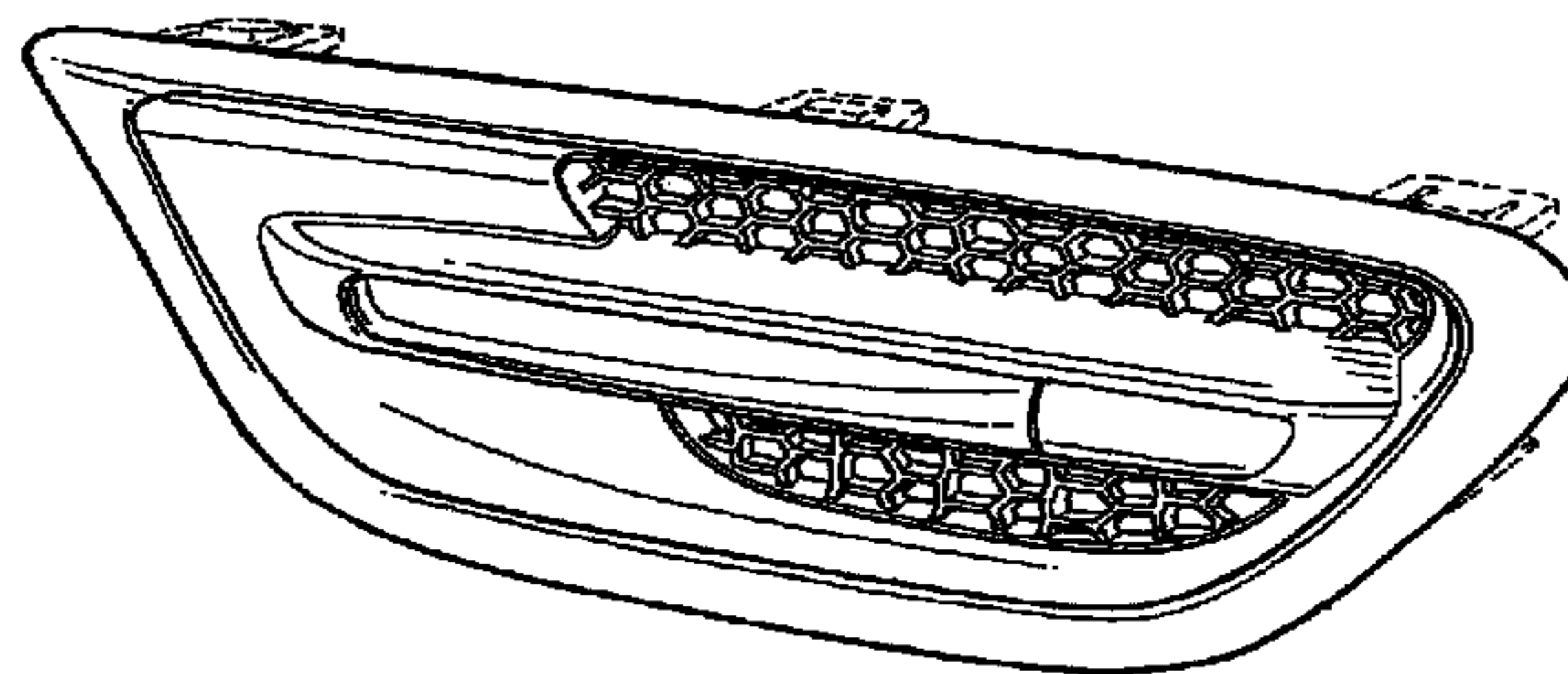
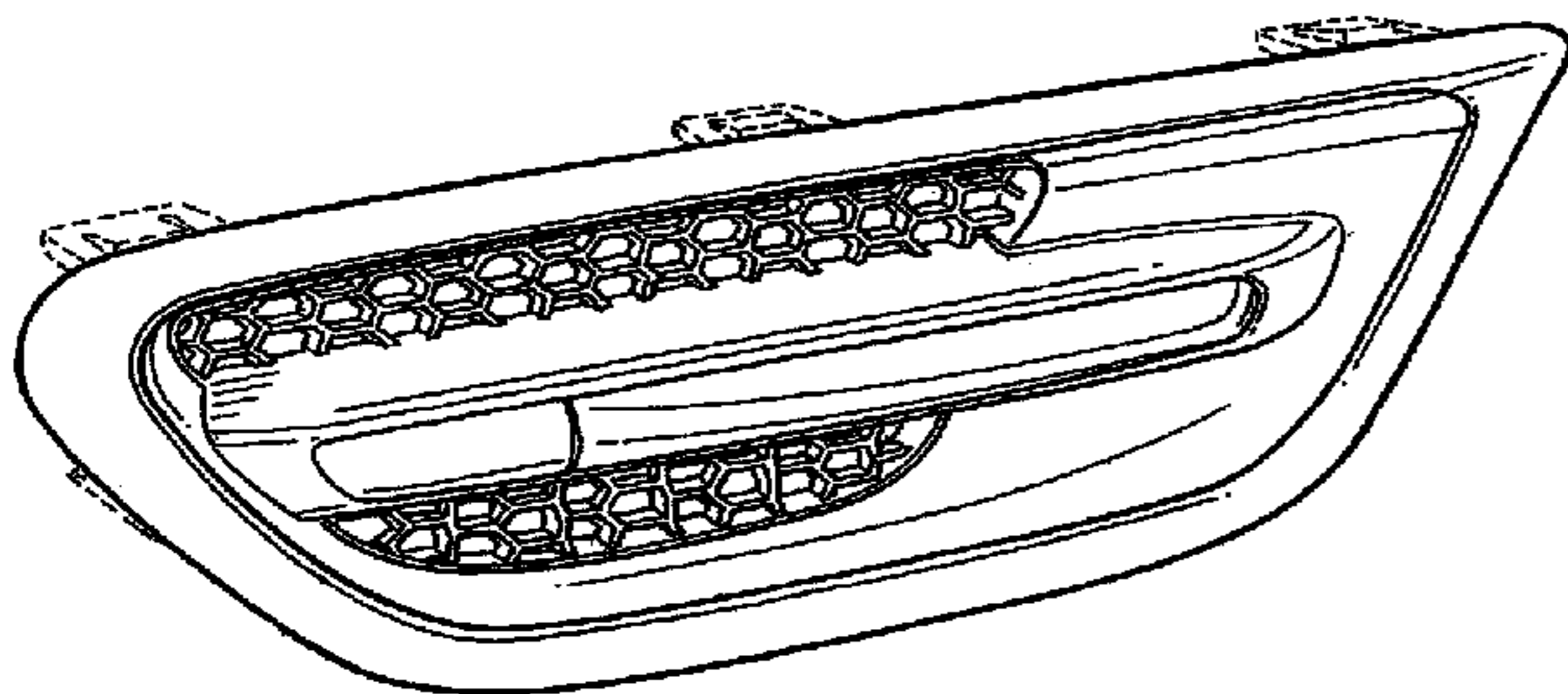

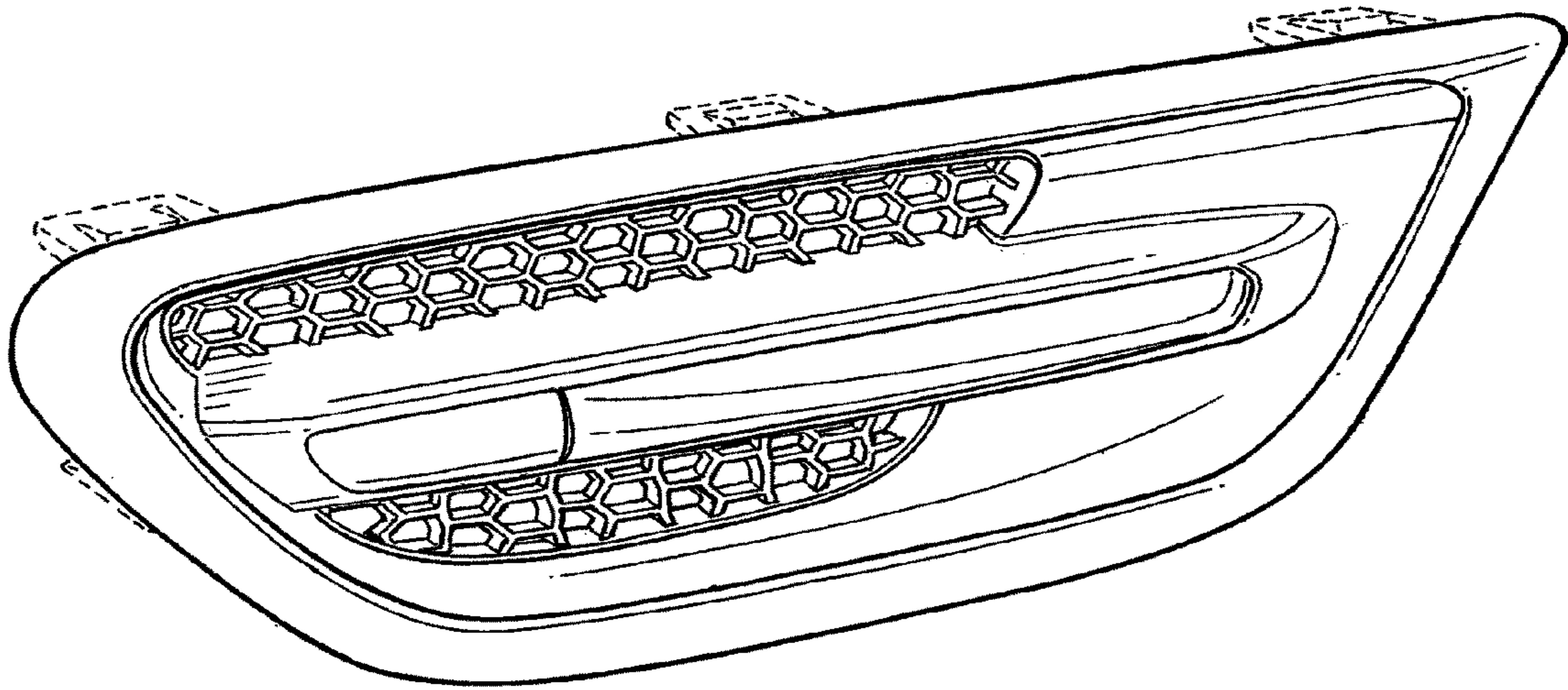

FIG. 1

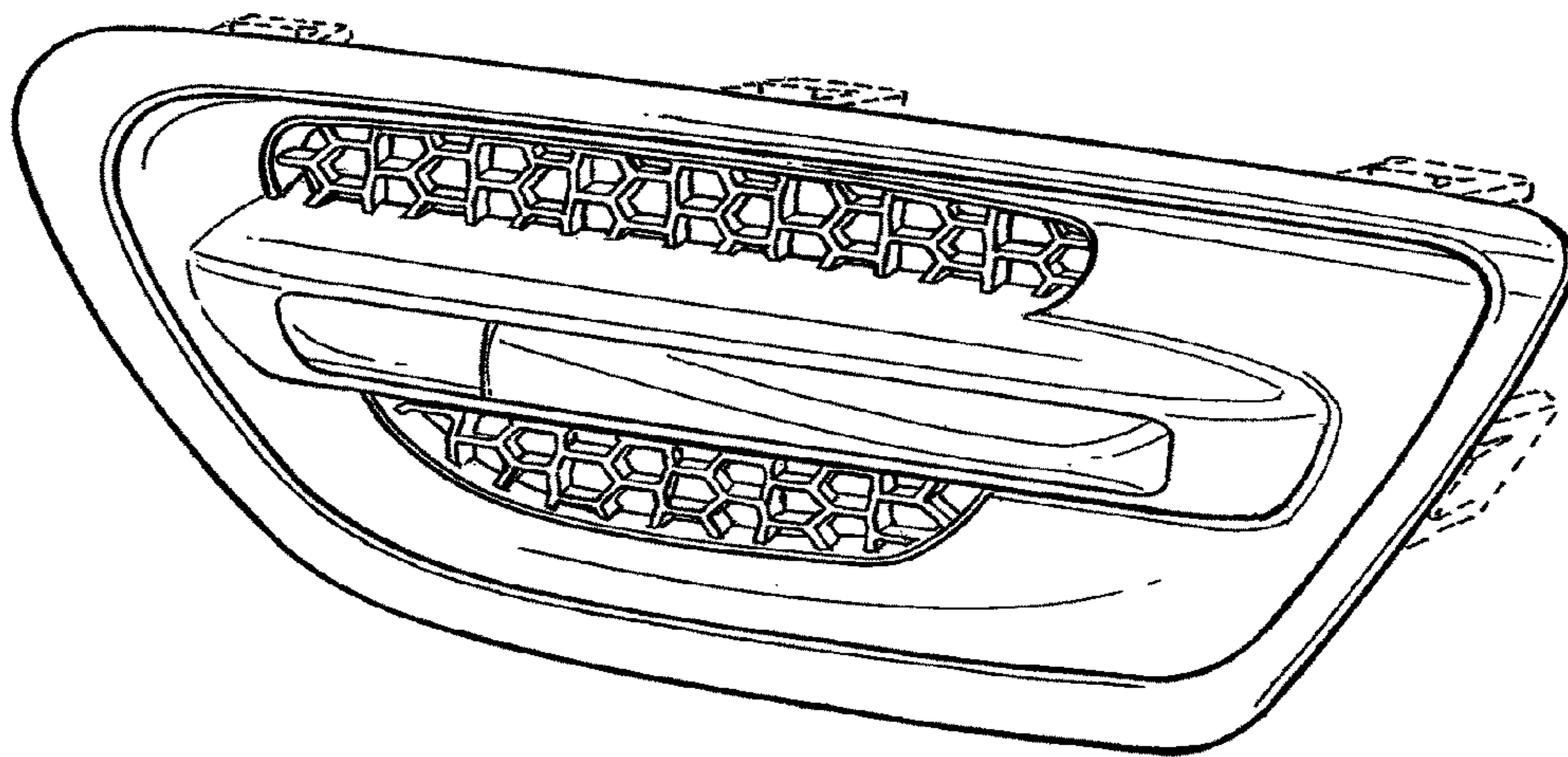

FIG. 2

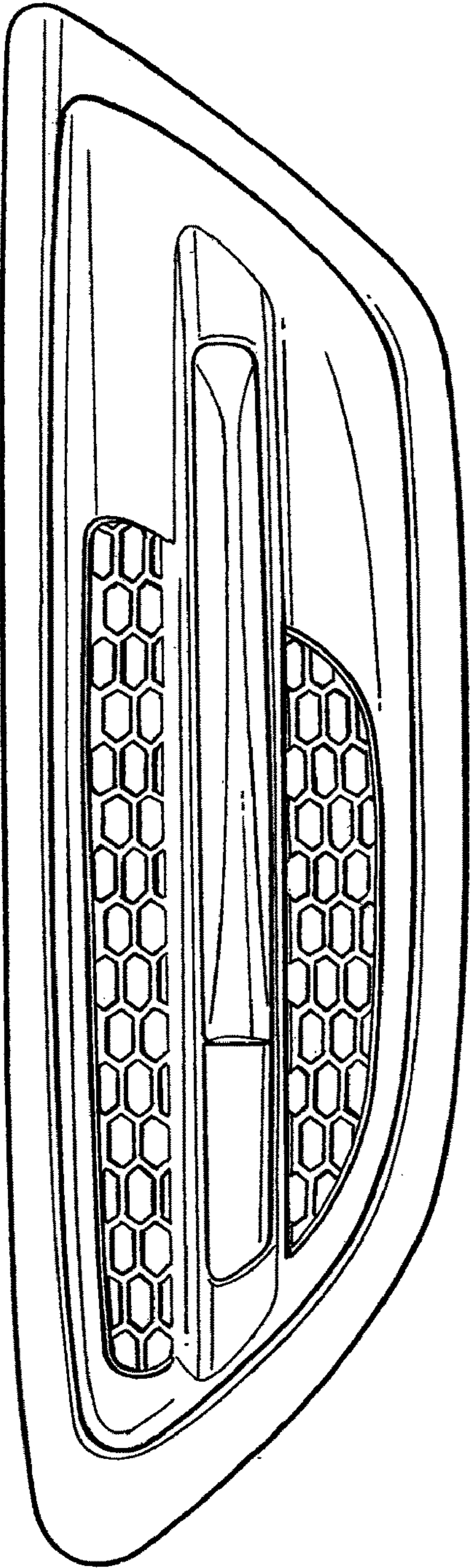

FIG. 3

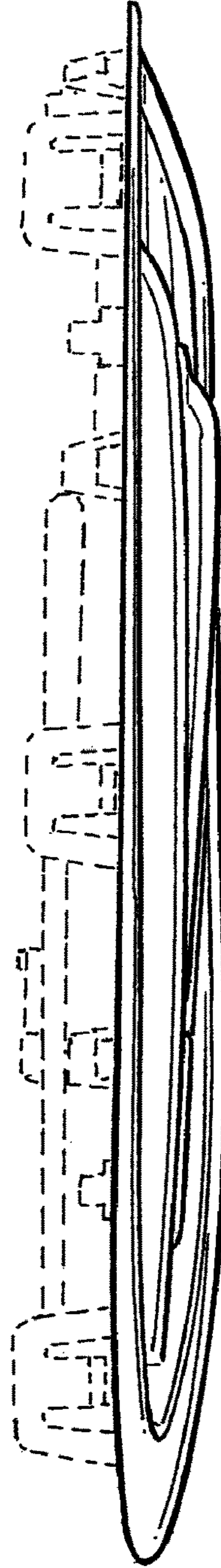

FIG. 4

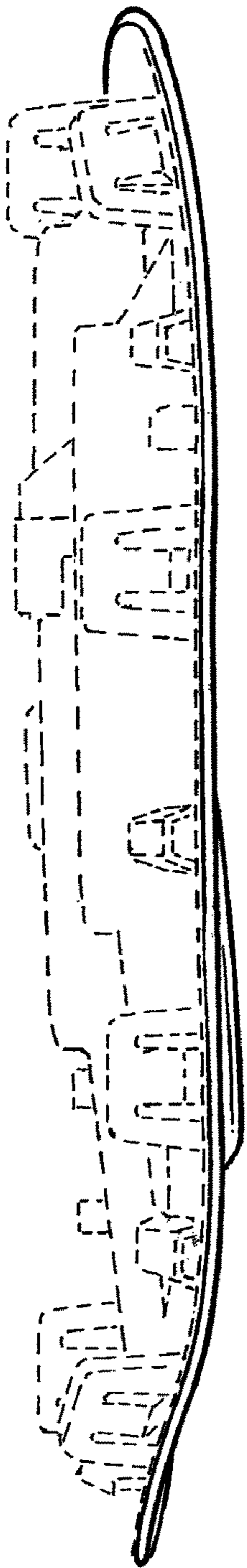

FIG. 5

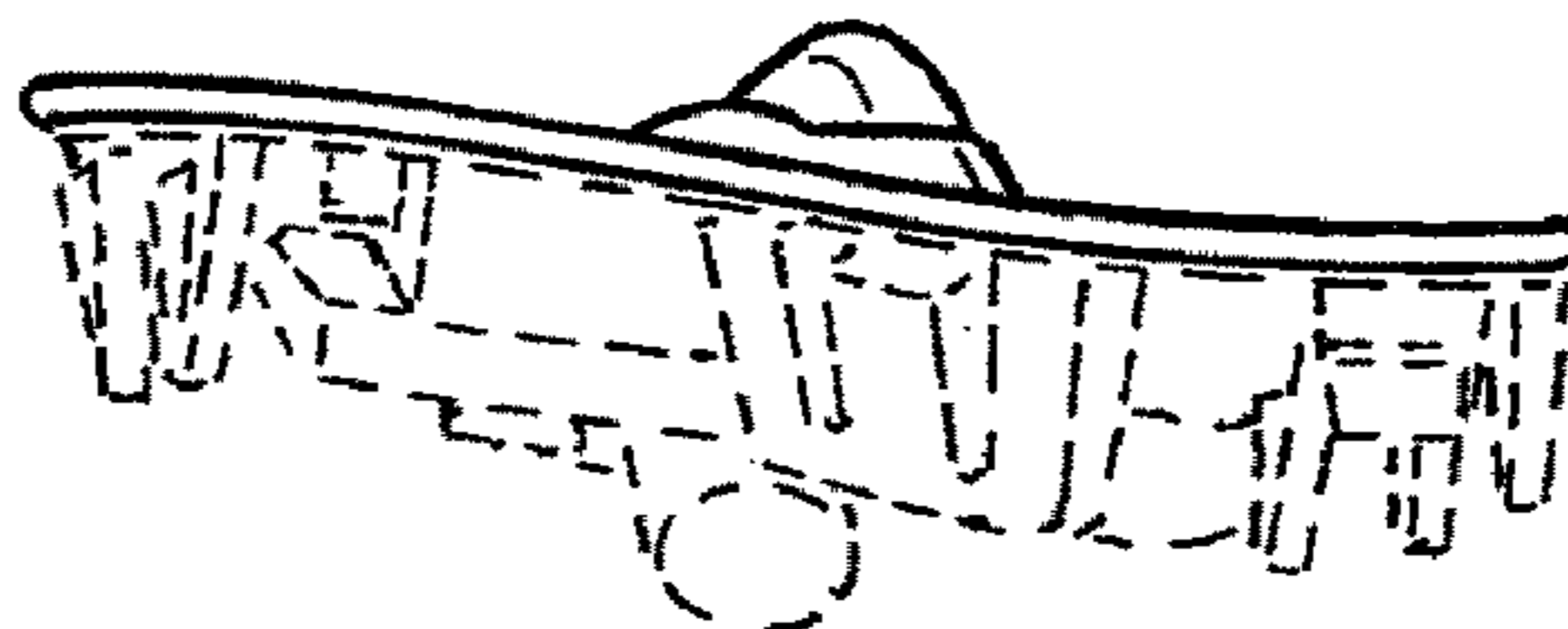

FIG. 7

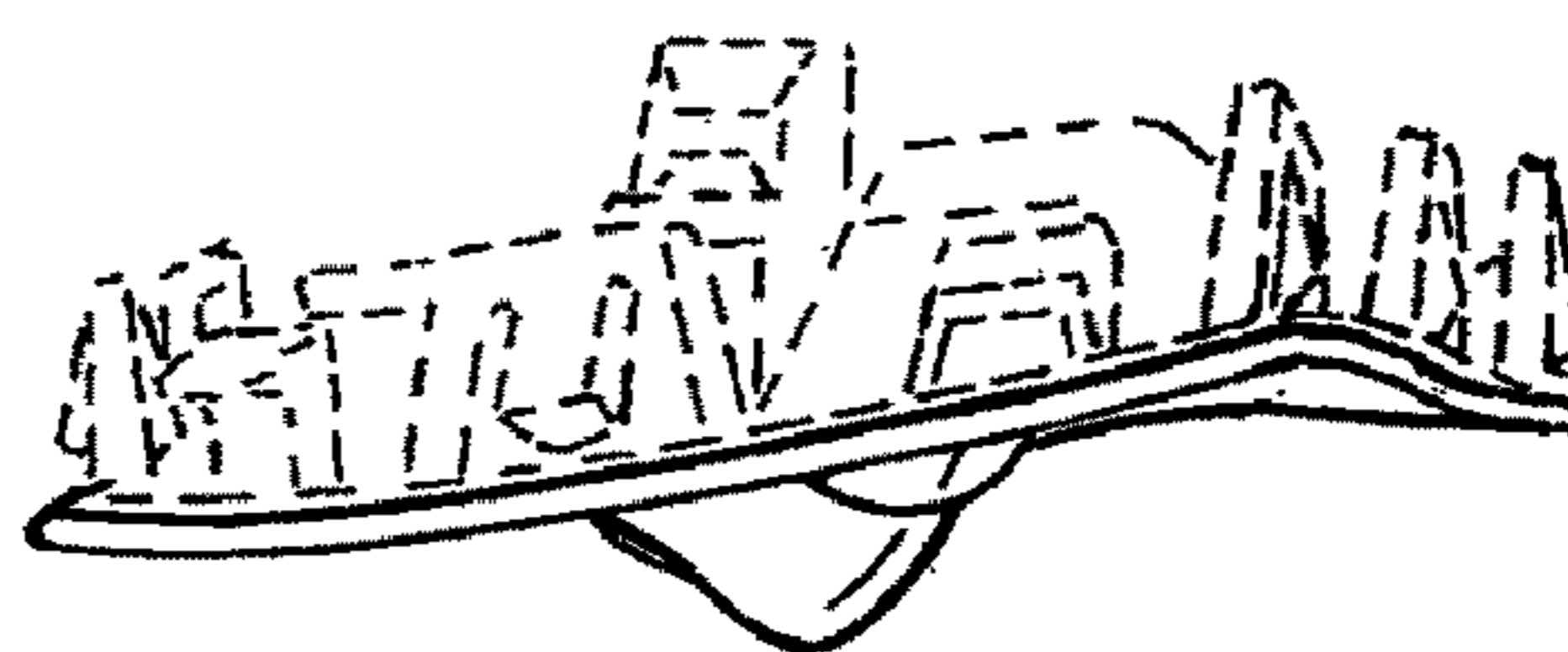

FIG. 6

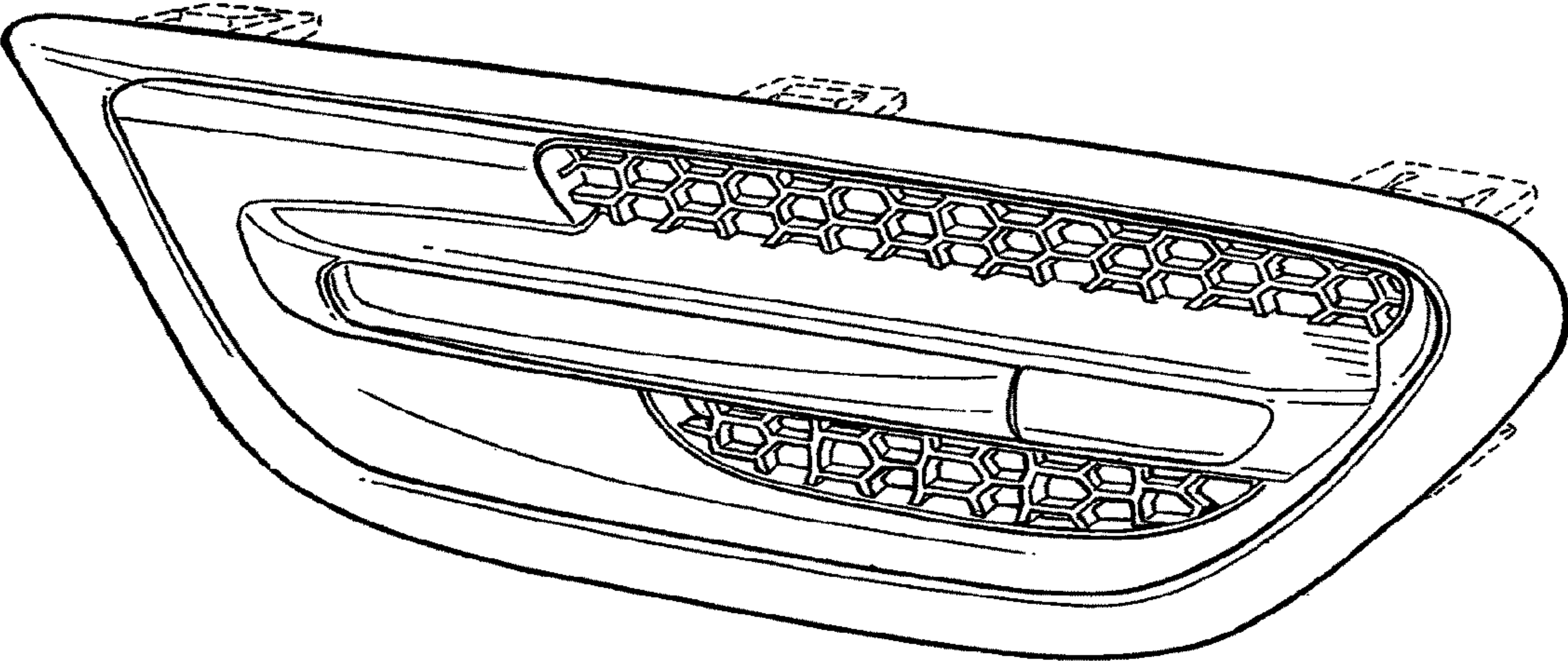

FIG. 8

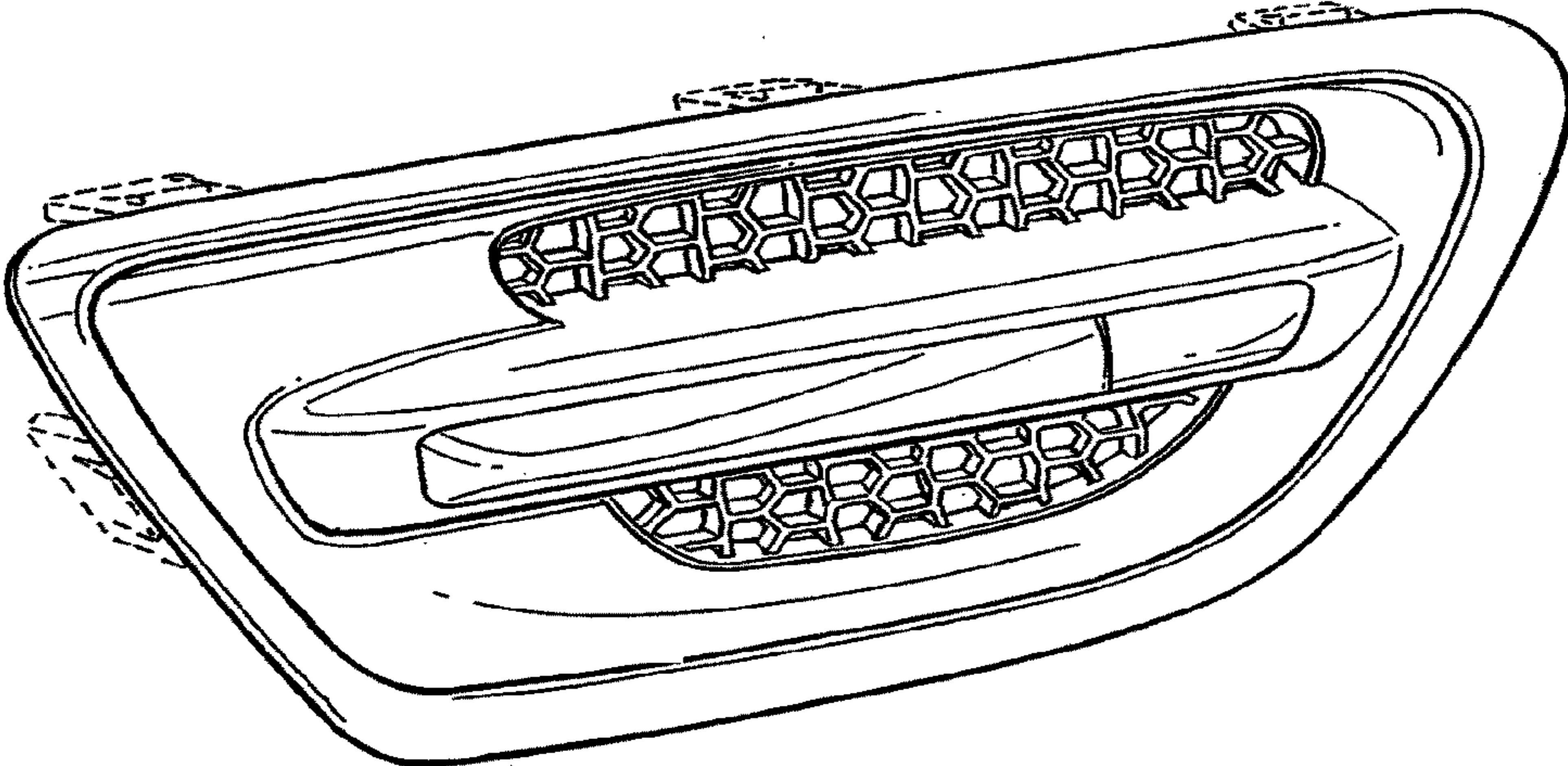

FIG. 9

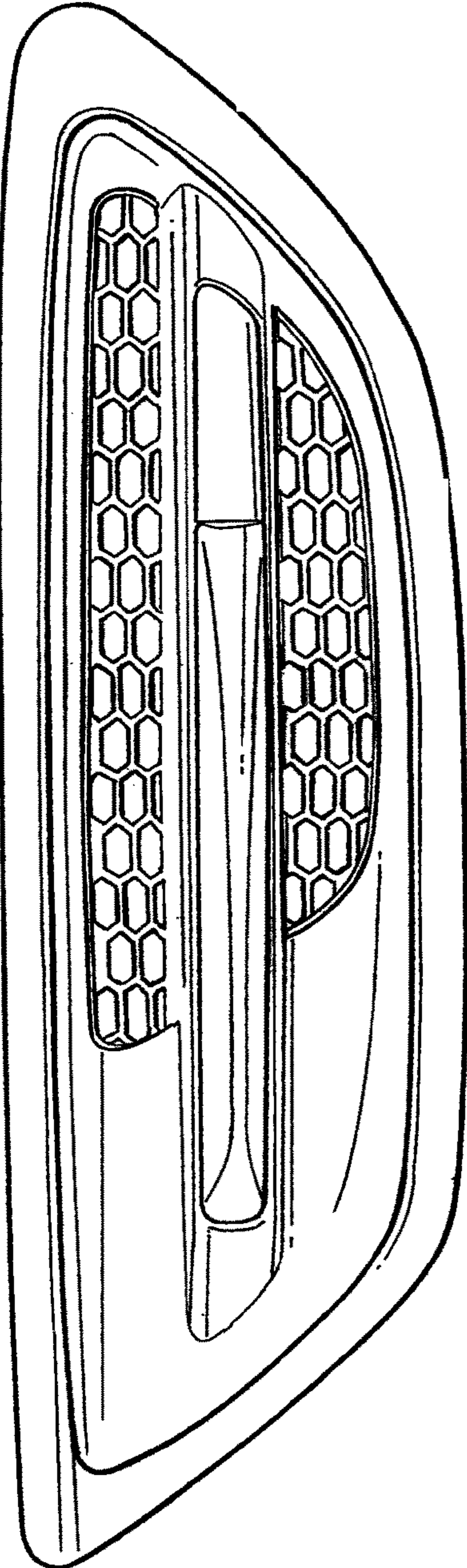

FIG. 10

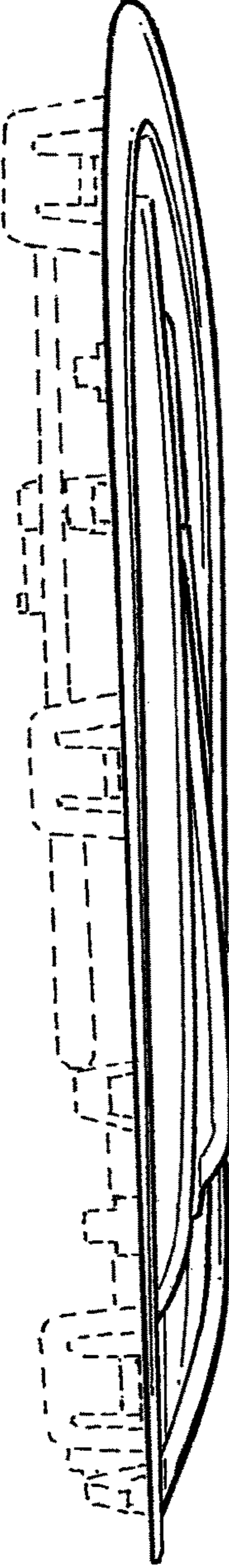

FIG. 11

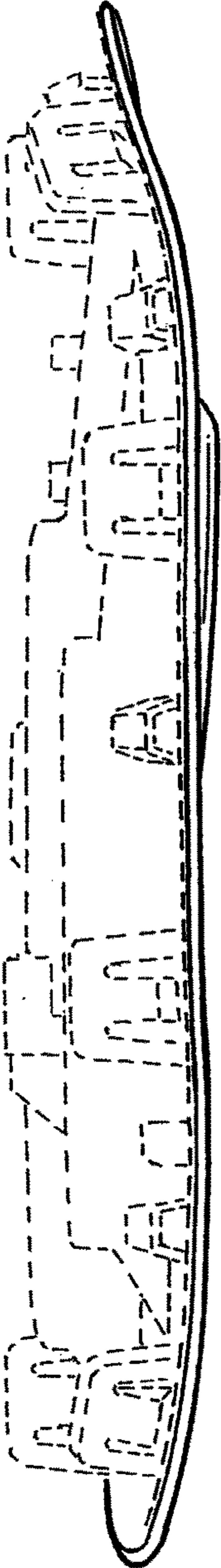

FIG. 12

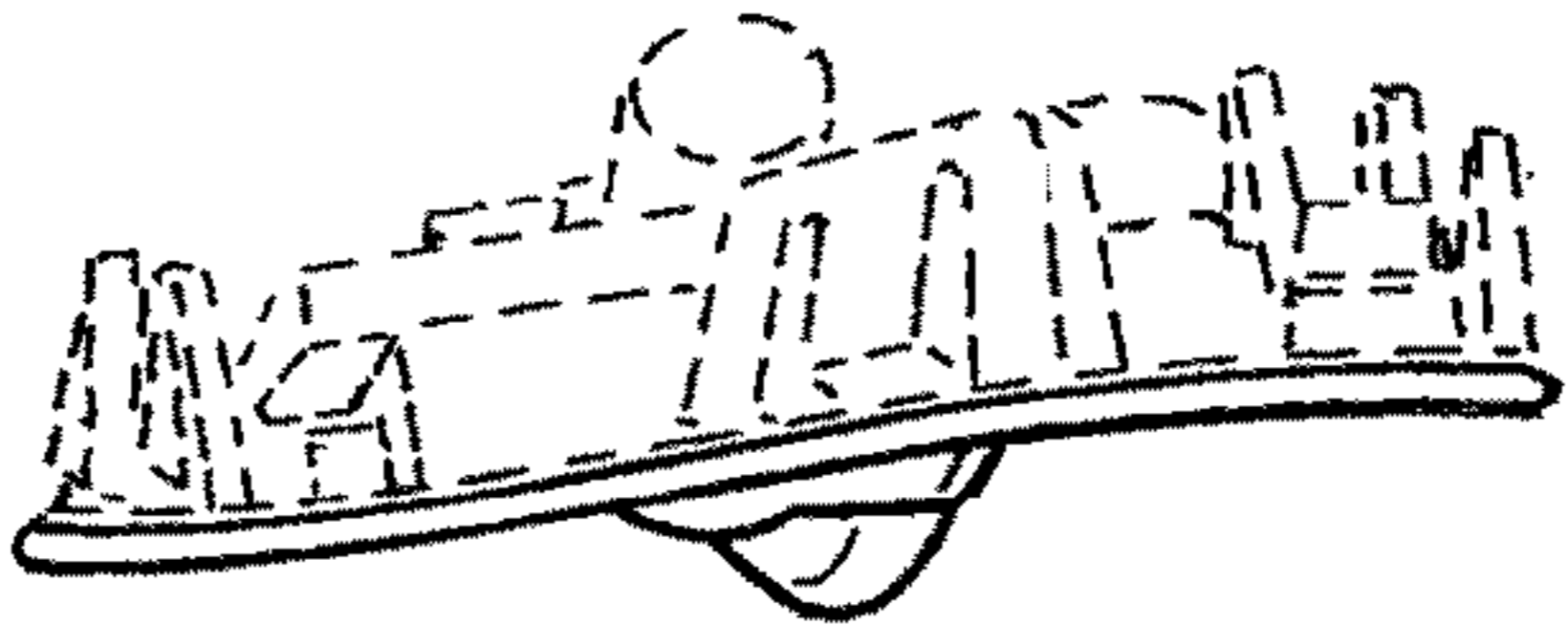

FIG. 14

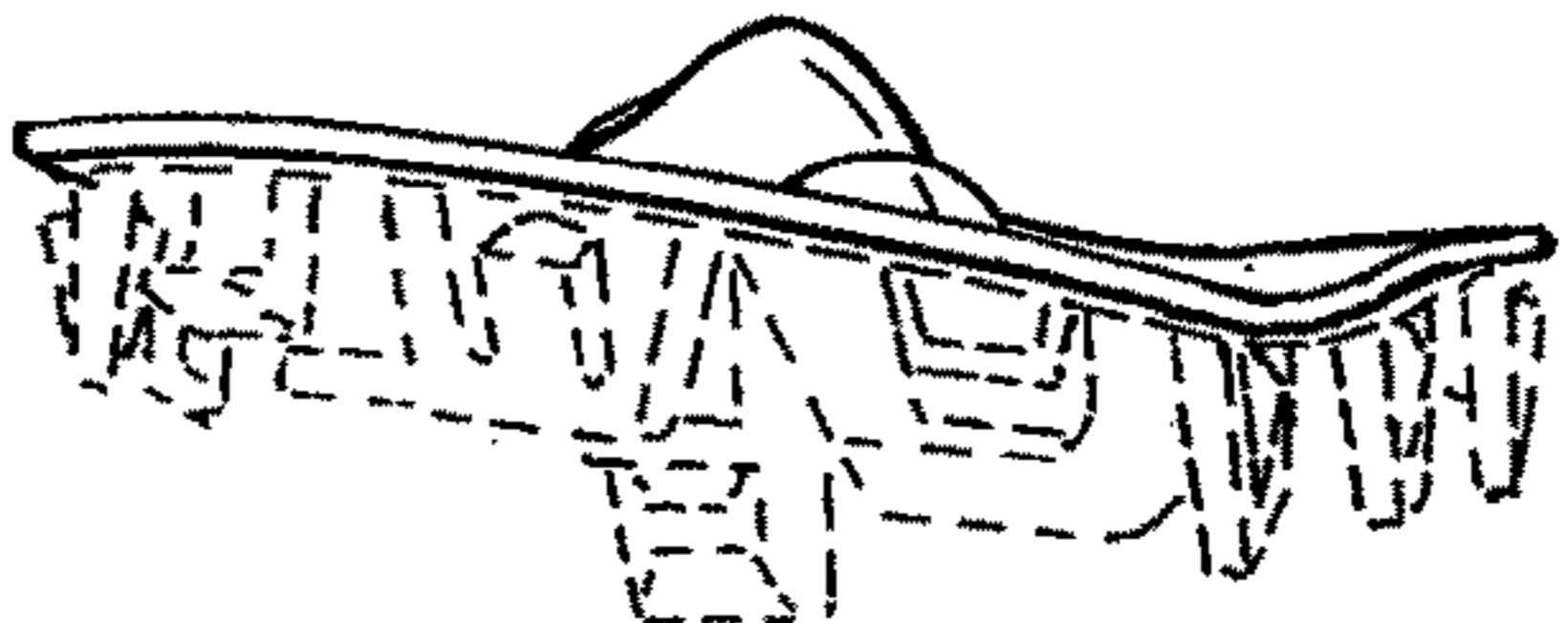

FIG. 13