



US00D659037S

(12) **United States Design Patent**
Madsen et al.

(10) **Patent No.:** **US D659,037 S**
(45) **Date of Patent:** **** May 8, 2012**

(54) **PERSONAL TRACKER**

(75) Inventors: **Christopher Jennings Madsen**, Waseca, MN (US); **Elliott D. Hoole**, Sammamish, WA (US)

(73) Assignee: **Recon Dynamics LLC**, Kirkland, WA (US)

(**) Term: **14 Years**

(21) Appl. No.: **29/381,868**

(22) Filed: **Dec. 23, 2010**

(51) **LOC (9) Cl.** **10-04**

(52) **U.S. Cl.** **D10/65; D10/70**

(58) **Field of Classification Search** D10/65, D10/70, 104.2, 106.6; D14/341, 344, 507, D14/138 R, 138 AA, 203.3, 203.4, 203.5, D14/203.7, 217, 137, 138 AB, 240–242, D14/356–358, 371, 140.1–140.6, 140, 155, D14/159, 149, 150, 170, 171, 125, 188, 336, D14/315, 337, 342, 343; 342/306, 351, 419, 342/457, 357.2–357.77; 343/702; 345/87, 345/104, 133, 156, 168, 173, 901–905; 348/180, 348/184, 315, 739; 364/444, 499; 701/206–209, 701/213, 214; 455/66.1, 404.2, 415, 456.1
See application file for complete search history.

(56) **References Cited**

U.S. PATENT DOCUMENTS

D557,624 S * 12/2007 Coster et al. D10/70
D611,847 S * 3/2010 Fraser et al. D10/70

D614,979 S * 5/2010 McNames et al. D10/70
D638,320 S * 5/2011 Thing D10/70
D648,232 S * 11/2011 Reigneau D10/65

* cited by examiner

Primary Examiner — Antoine D Davis

(74) *Attorney, Agent, or Firm* — Michael J. Donohue; Davis Wright Tremaine LLP

(57) **CLAIM**

The ornamental design for an personal tracker, as shown and described.

DESCRIPTION

FIG. 1 is an isometric view of the asset tracker
FIG. 2 is a front elevation view
FIG. 3 is a back elevation view
FIG. 4 is a left-side elevation view
FIG. 5 is a right-side elevation view
FIG. 6 is a top view
FIG. 7 is a bottom view
FIG. 8 is an isometric view of an alternative embodiment of the personal tracker
FIG. 9 is a front elevation view of an alternative embodiment
FIG. 10 is a back elevation view of an alternative embodiment
FIG. 11 is a left-side elevation view of an alternative embodiment
FIG. 12 is a right-side elevation view of an alternative embodiment
FIG. 13 is a top view of an alternative embodiment; and, FIG. 14 is a bottom view of an alternative embodiment.
The broken line showing of structural features is included for the purpose of illustrating non-claimed subject matter and forms no part of the claimed design.

1 Claim, 10 Drawing Sheets

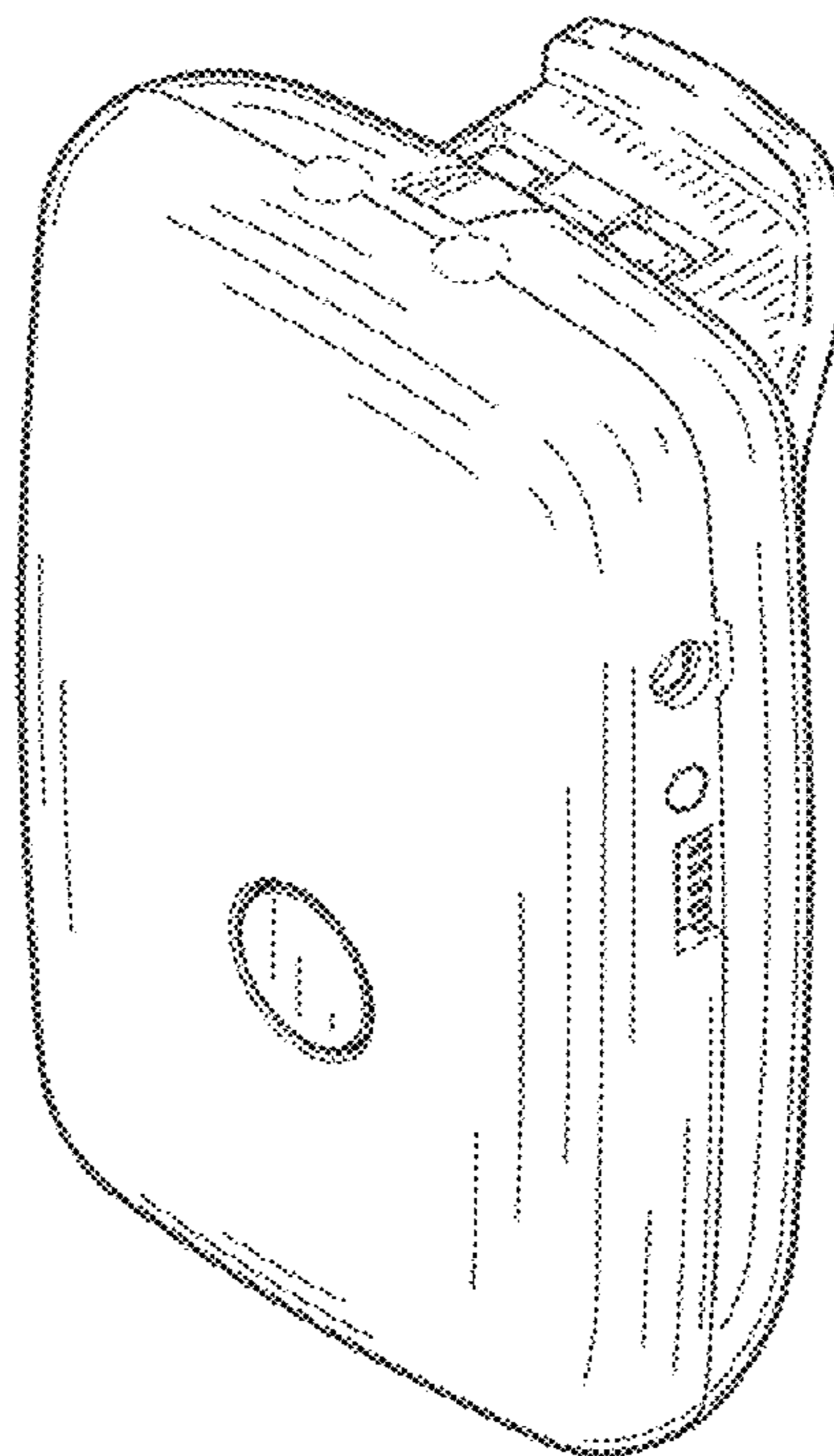

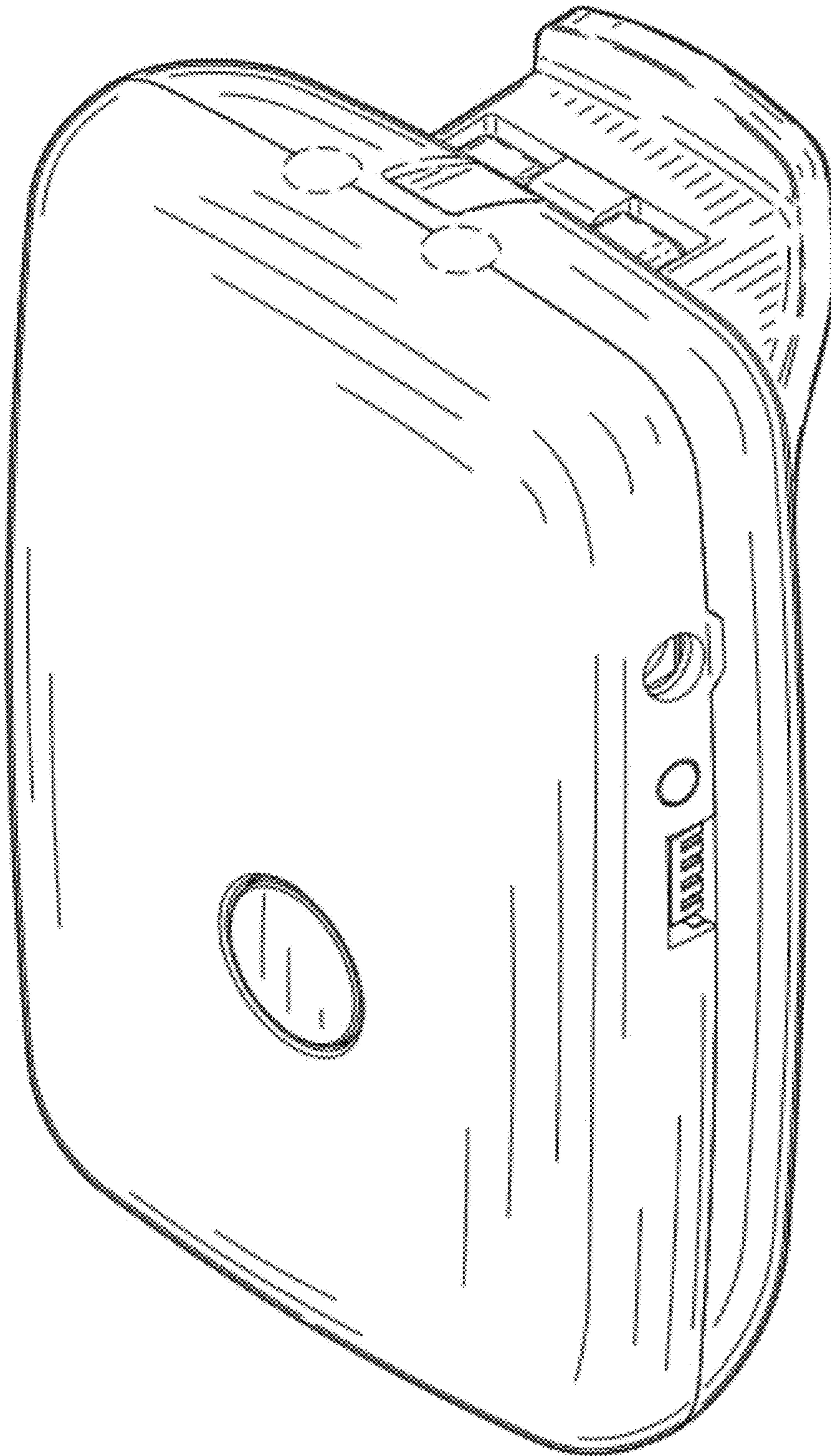

FIG. 1

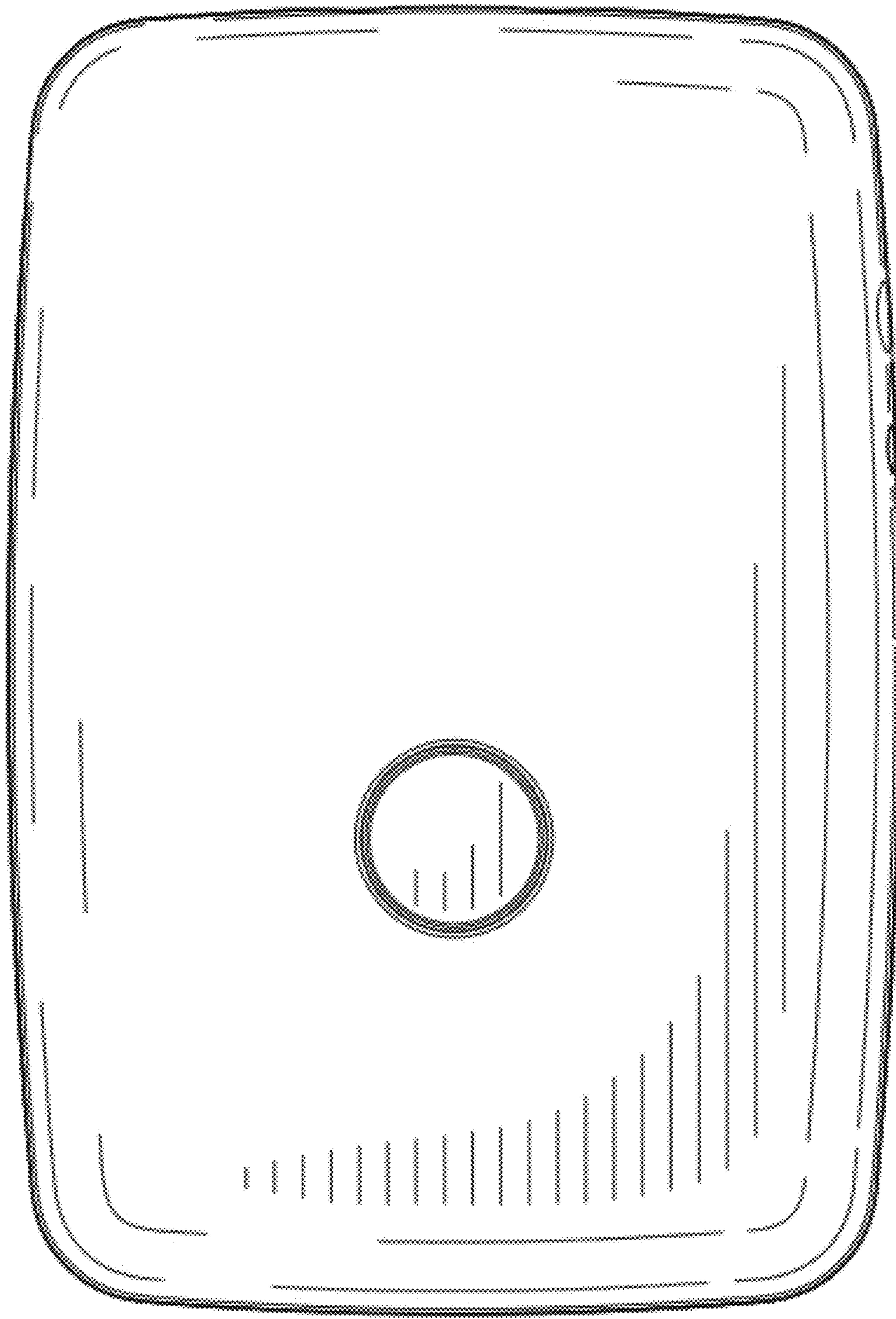

FIG. 2

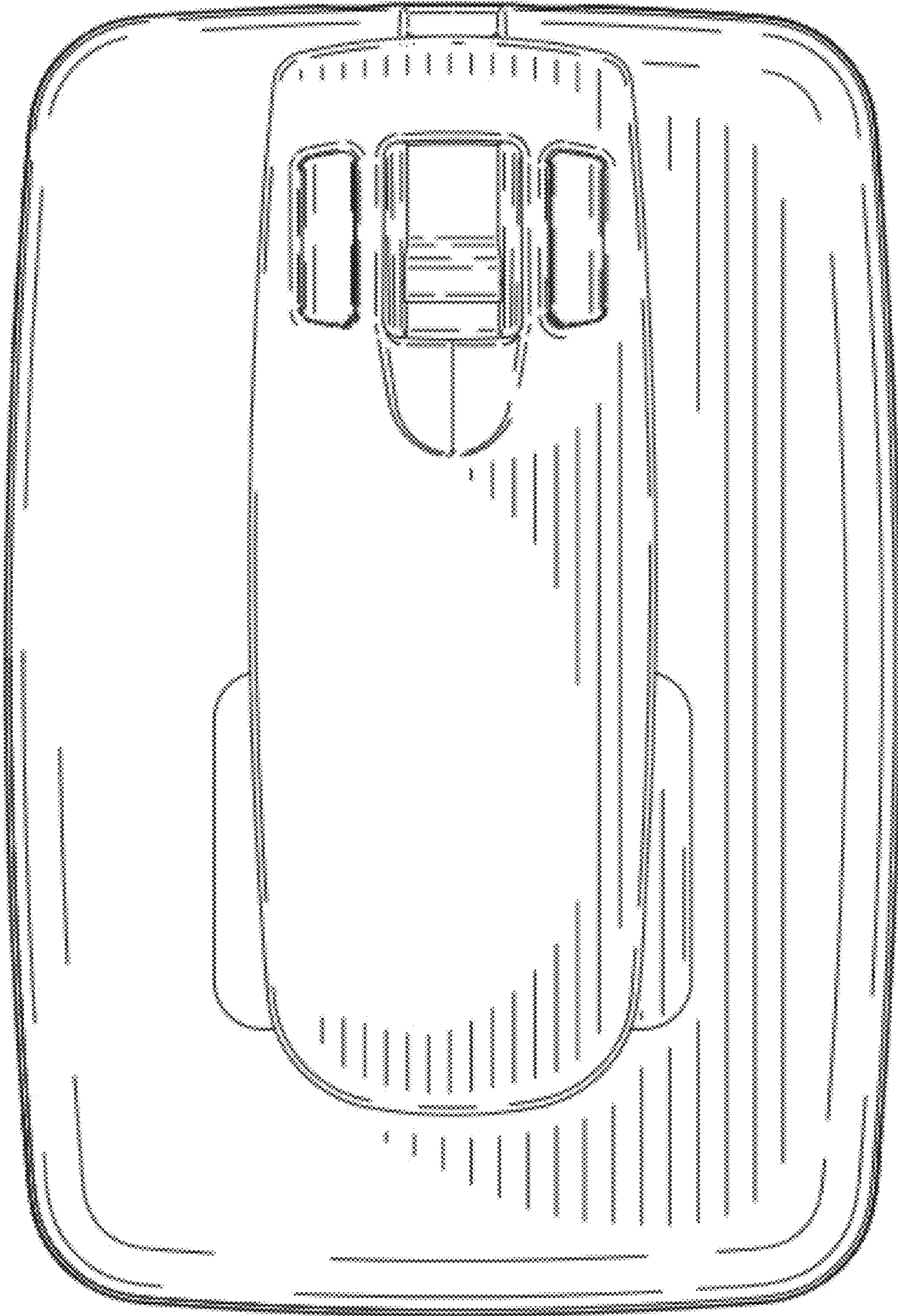

FIG. 3

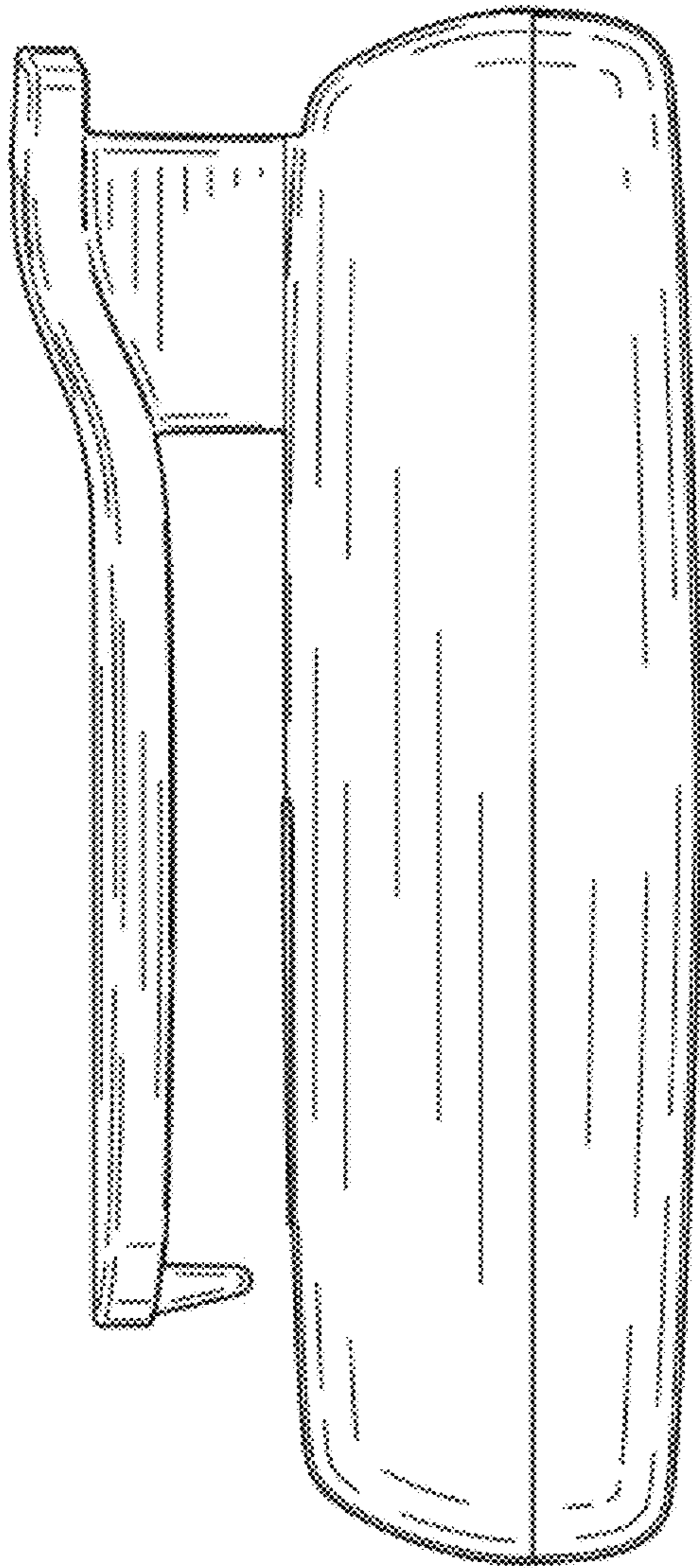

FIG. 4

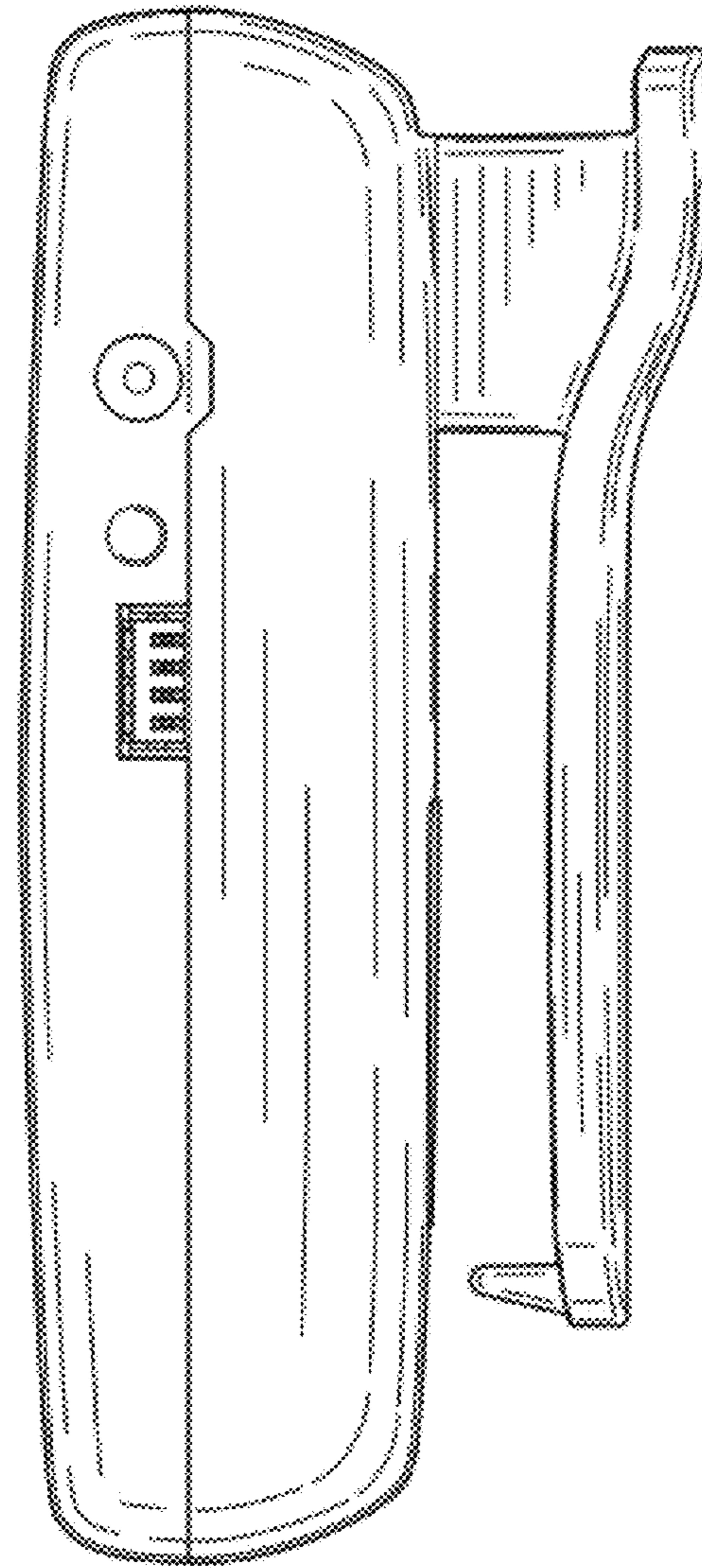

FIG. 5

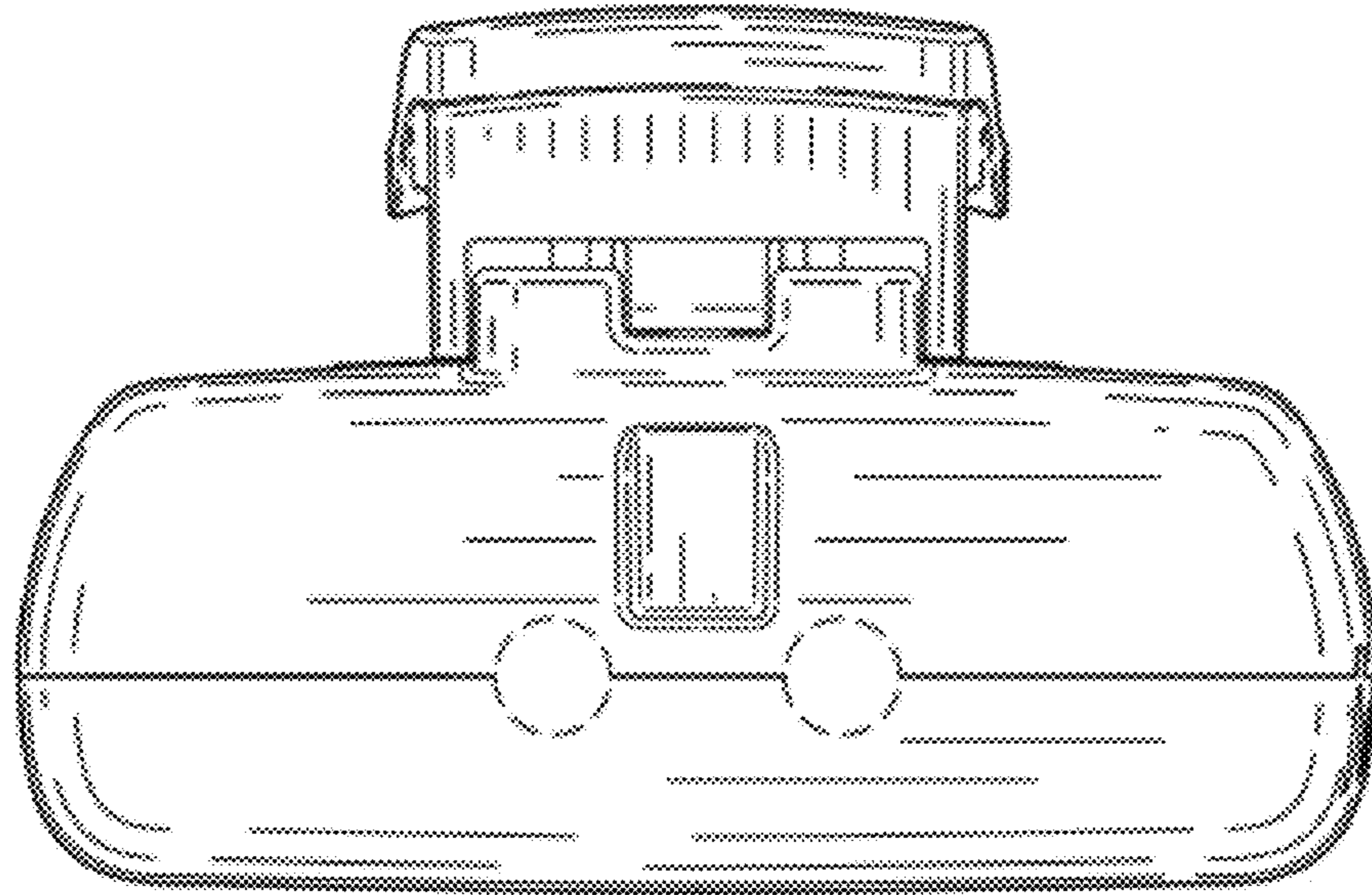

FIG. 6

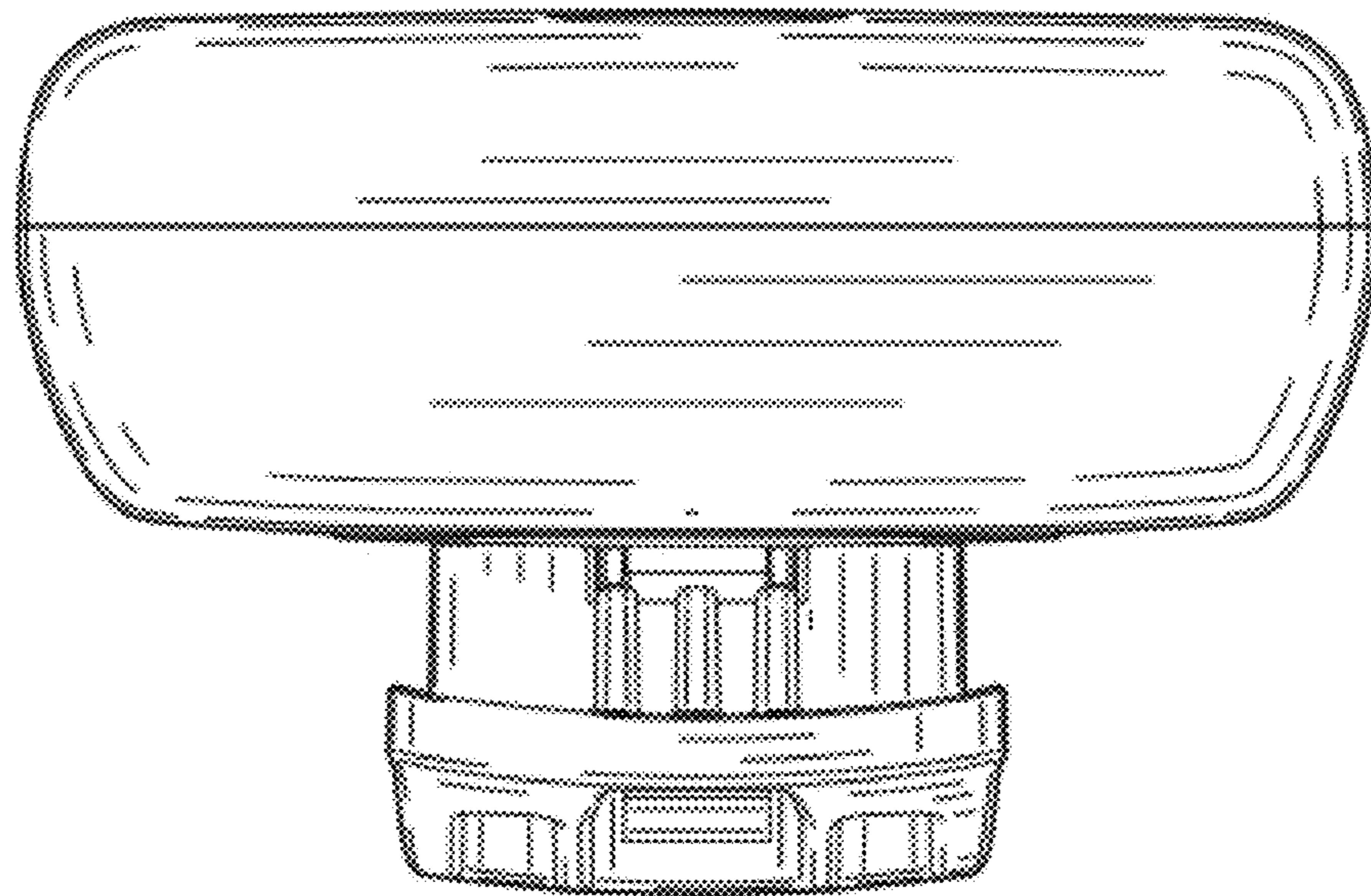

FIG. 7

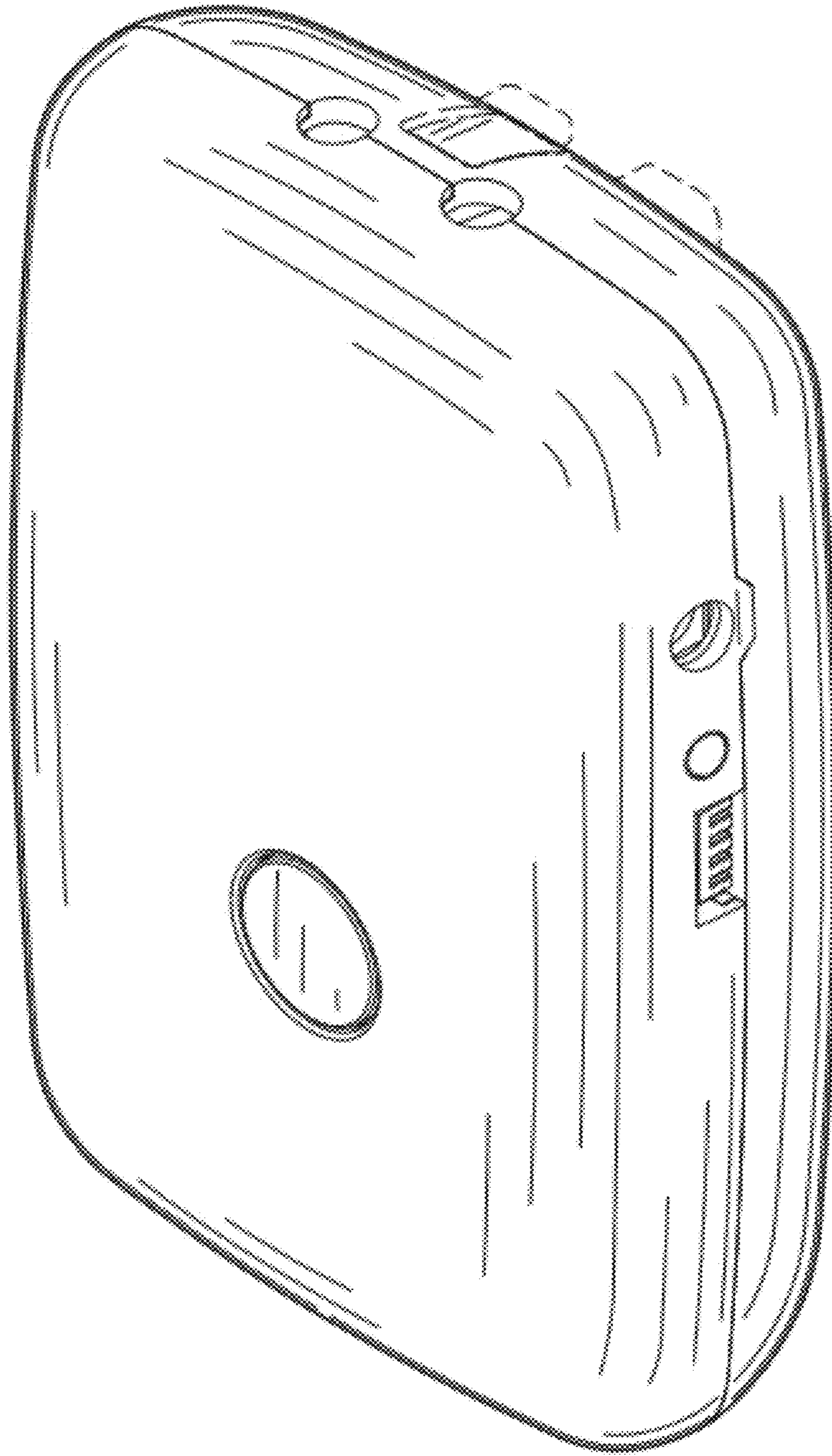

FIG. 8

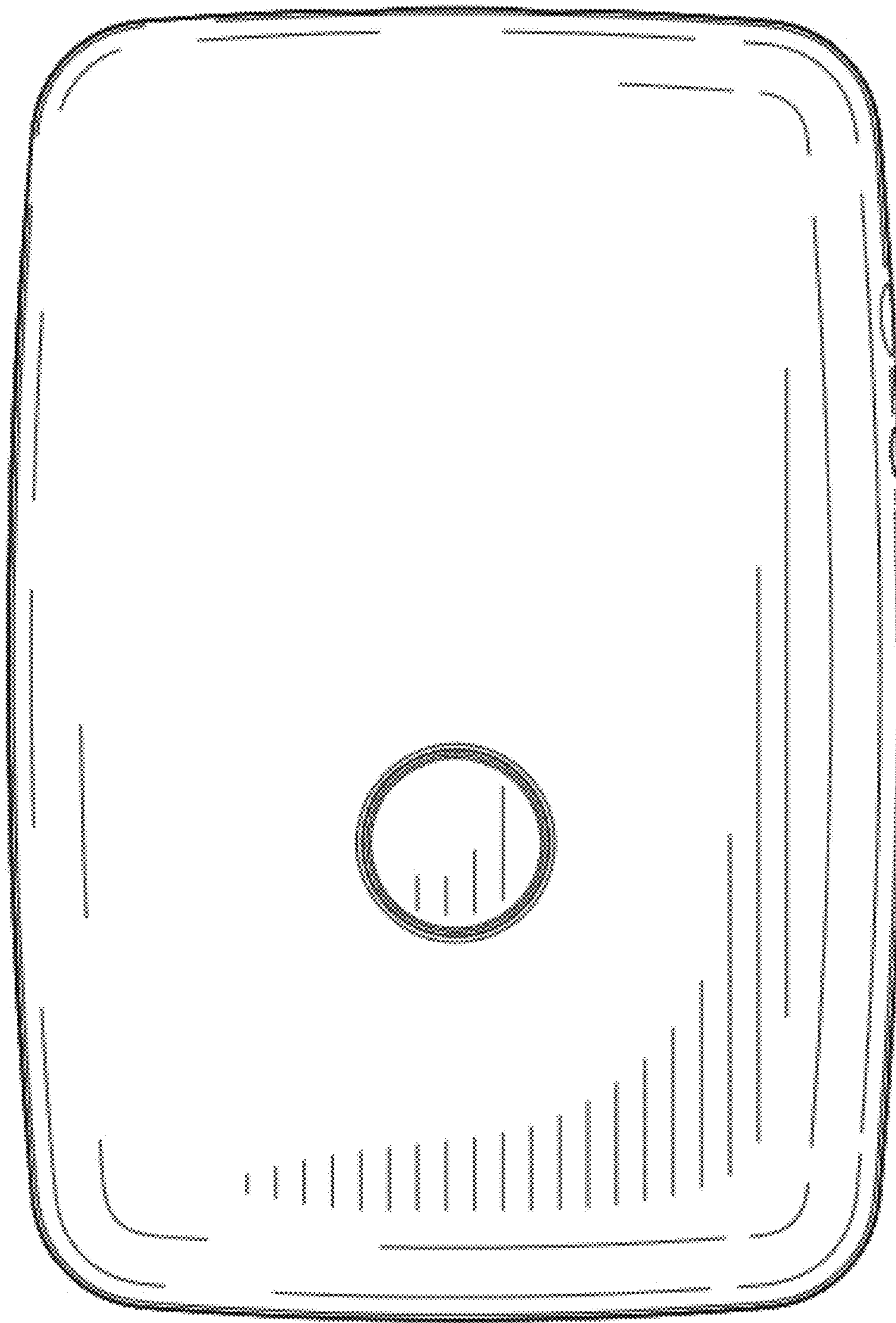

FIG. 9

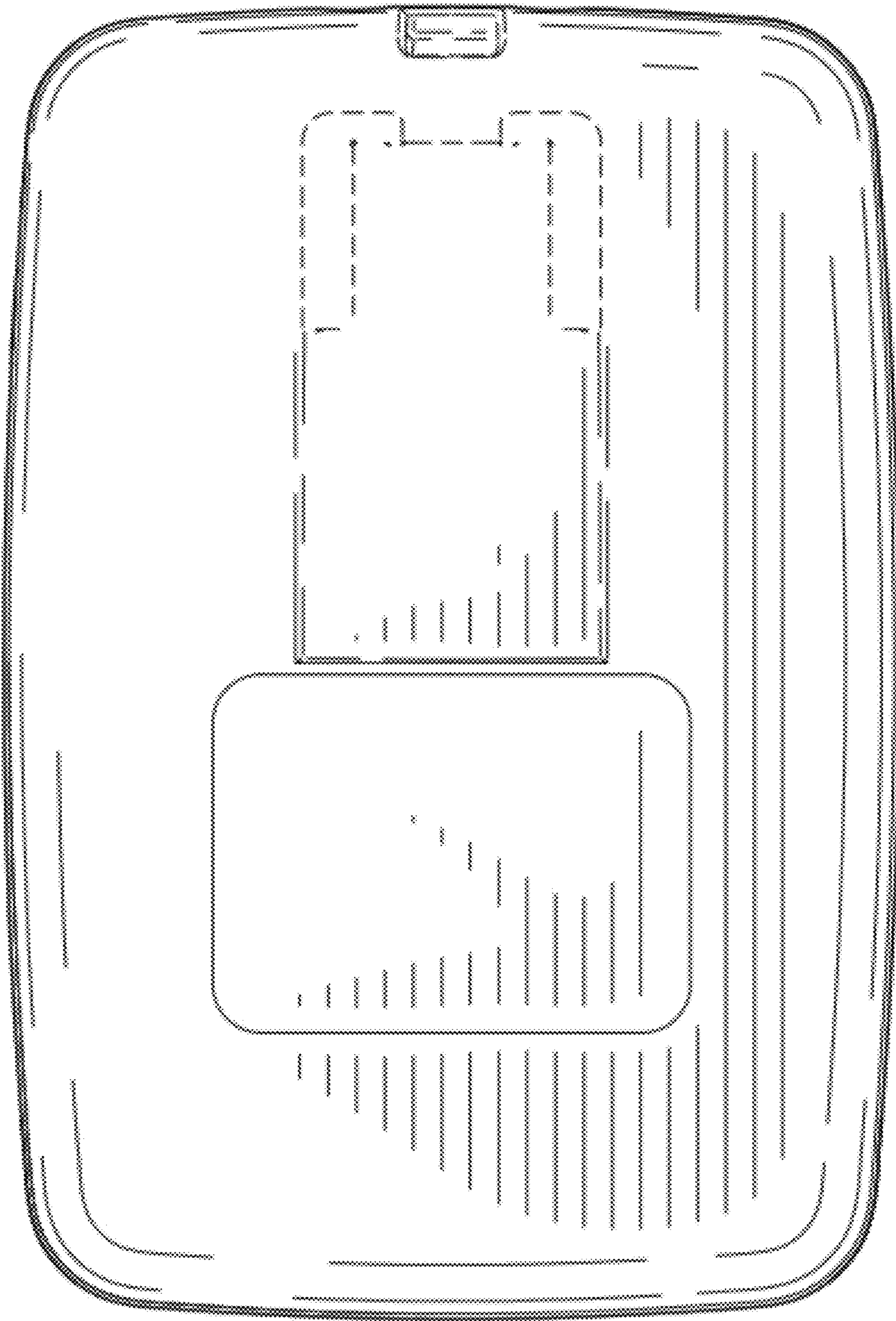

FIG. 10

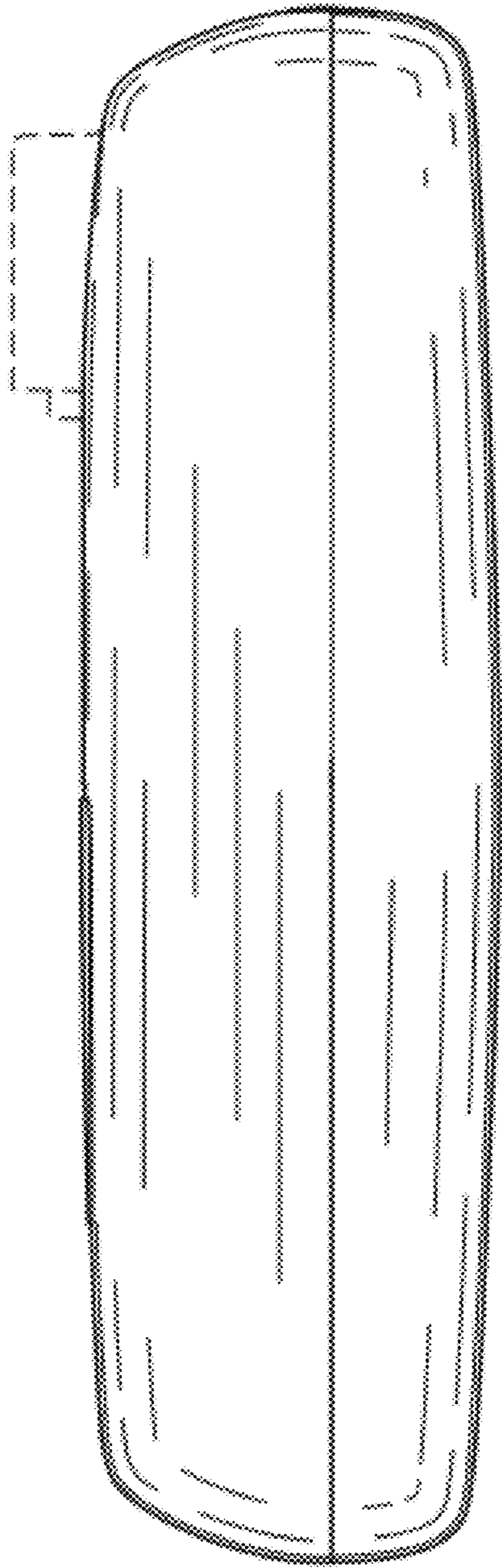

FIG. 11

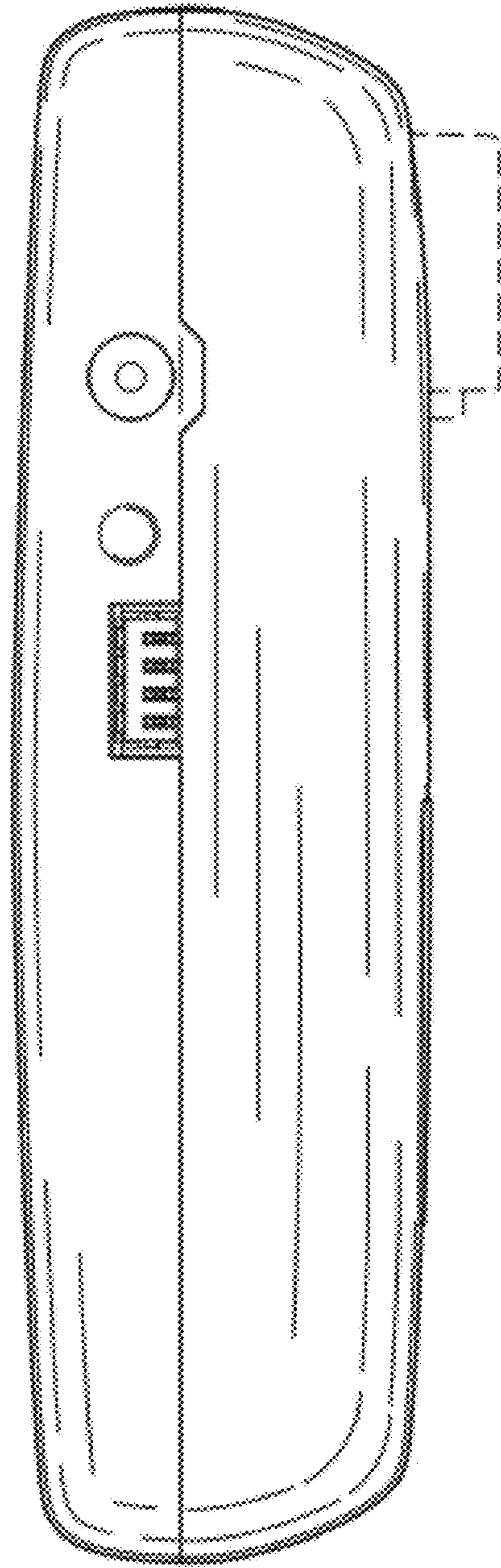

FIG. 12

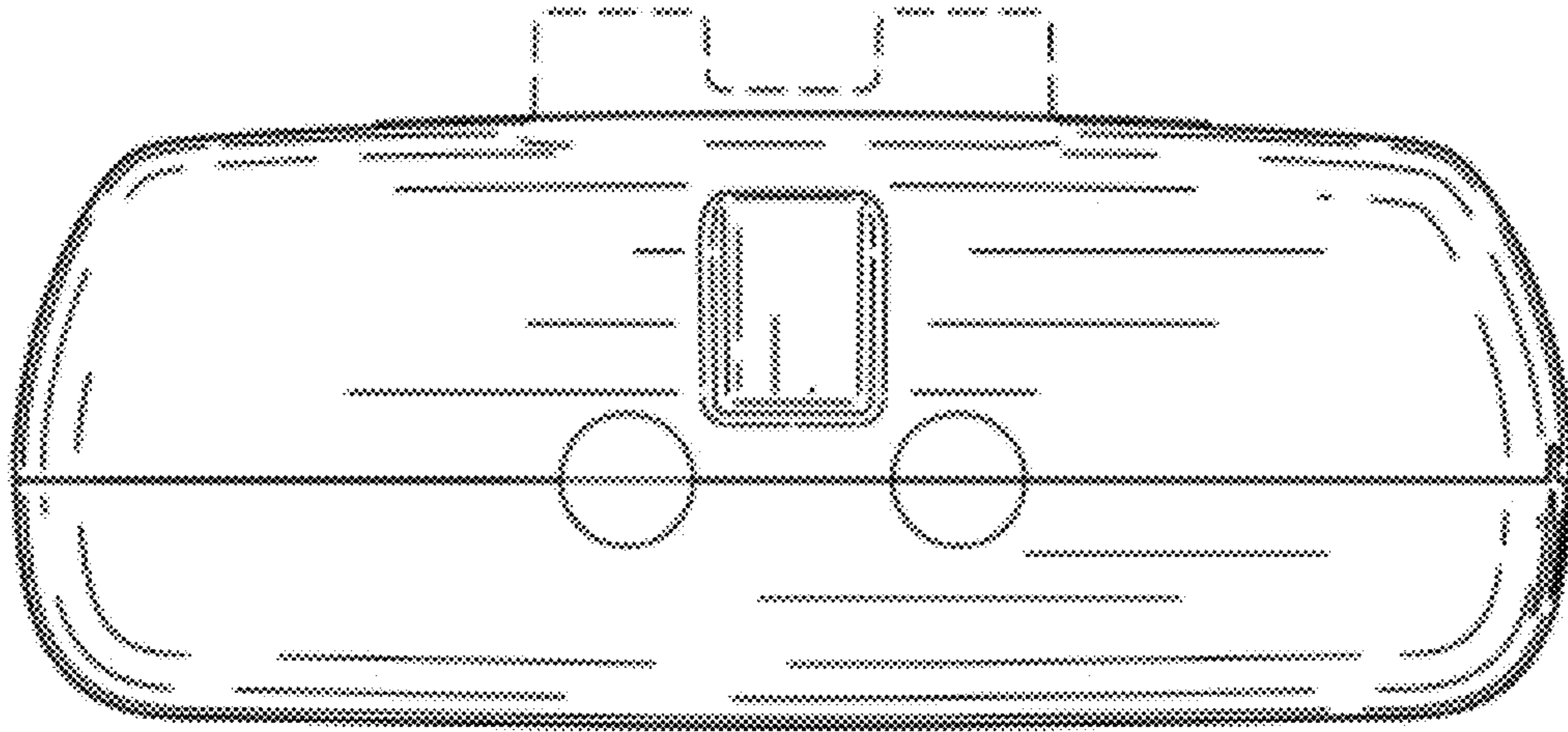

FIG.13

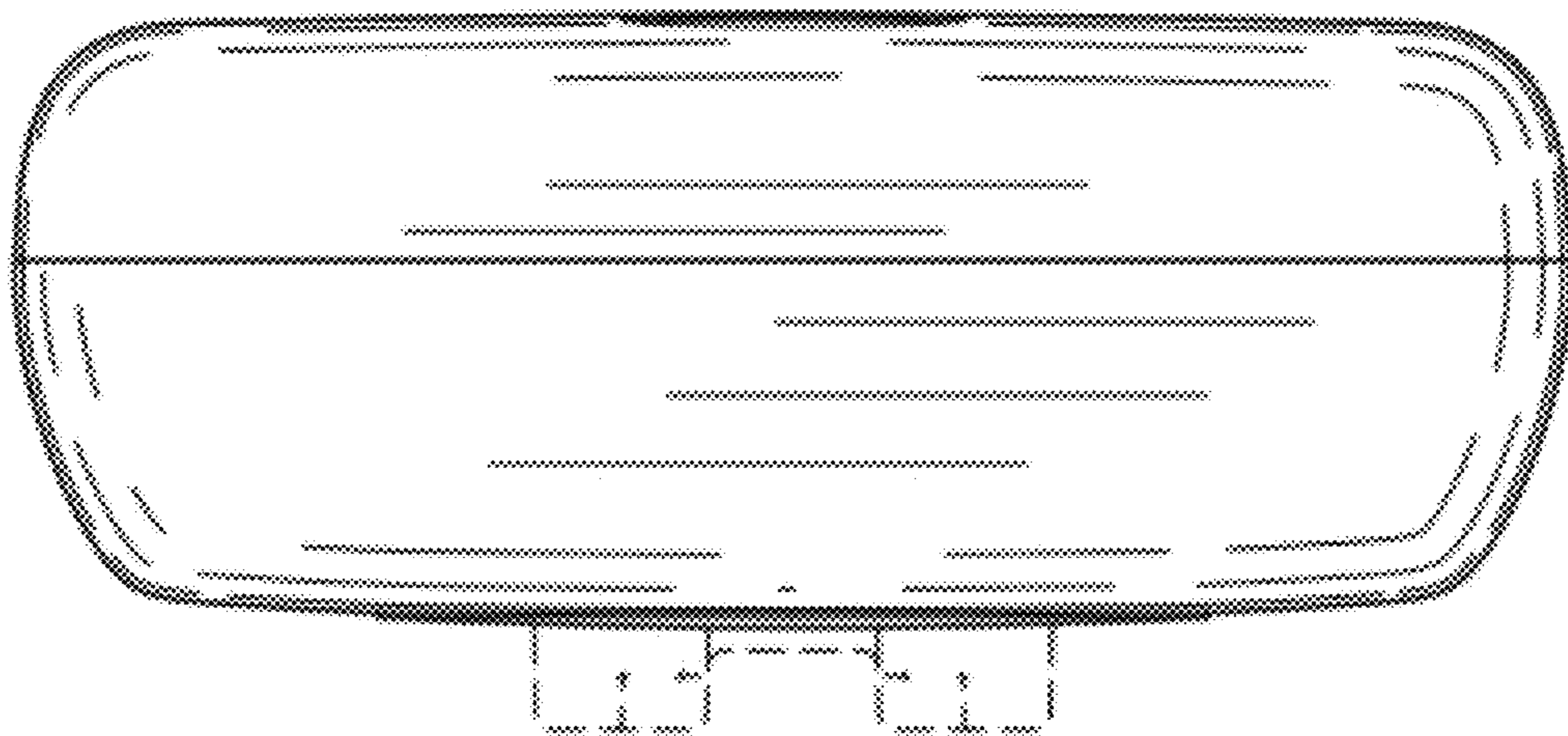

FIG.14