



US00D658904S

(12) **United States Design Patent**
Chen

(10) **Patent No.:** **US D658,904 S**
(45) **Date of Patent:** **** May 8, 2012**

(54) **CHAIR**

(75) Inventor: **Te-Sheng Chen**, Yilan County (TW)

(73) Assignee: **Xcellent Products International Ltd.**,
New Taipei (TW)

(**) Term: **14 Years**

(21) Appl. No.: **29/380,229**

(22) Filed: **Dec. 2, 2010**

(30) **Foreign Application Priority Data**

Aug. 23, 2010 (CN) 2010 3 0285113

(51) **LOC (9) Cl.** **06-01**

(52) **U.S. Cl.** **D6/366**

(58) **Field of Classification Search** D6/334-336,
D6/364, 365, 366, 367, 369, 374, 379, 380,
D6/498, 500-502; 297/284.4, 391, 396,
297/411.27, 452.13, 452.21, 452.29, 452.3,
297/452.46, 452.56

See application file for complete search history.

(56) **References Cited**

U.S. PATENT DOCUMENTS

D436,456 S * 1/2001 Neil D6/366
D481,879 S * 11/2003 Su D6/366

D486,656 S * 2/2004 Su D6/366
D487,359 S * 3/2004 Giugiaro D6/366
D507,124 S * 7/2005 Yang D6/366
D512,232 S * 12/2005 Wu D6/366
D549,976 S * 9/2007 Lin D6/366
D552,857 S * 10/2007 Wang D6/366
D557,028 S * 12/2007 Su D6/366
D572,493 S * 7/2008 Zhang D6/366
7,434,888 B2 * 10/2008 Lin 297/452.56
D585,205 S * 1/2009 Wen D6/366
7,731,295 B2 * 6/2010 Lin 297/452.13
D638,635 S * 5/2011 Sander et al. D6/366

* cited by examiner

Primary Examiner — Mimoso De

(74) *Attorney, Agent, or Firm* — CKC & Partners Co., Ltd.

(57) **CLAIM**

The ornamental design for a chair, as shown.

DESCRIPTION

FIG. 1 is a perspective view of a chair showing my new design;

FIG. 2 is a front view thereof;

FIG. 3 is a rear view thereof;

FIG. 4 is a left side view thereof;

FIG. 5 is a right side view thereof;

FIG. 6 is a top view thereof; and,

FIG. 7 is a bottom view thereof.

1 Claim, 6 Drawing Sheets

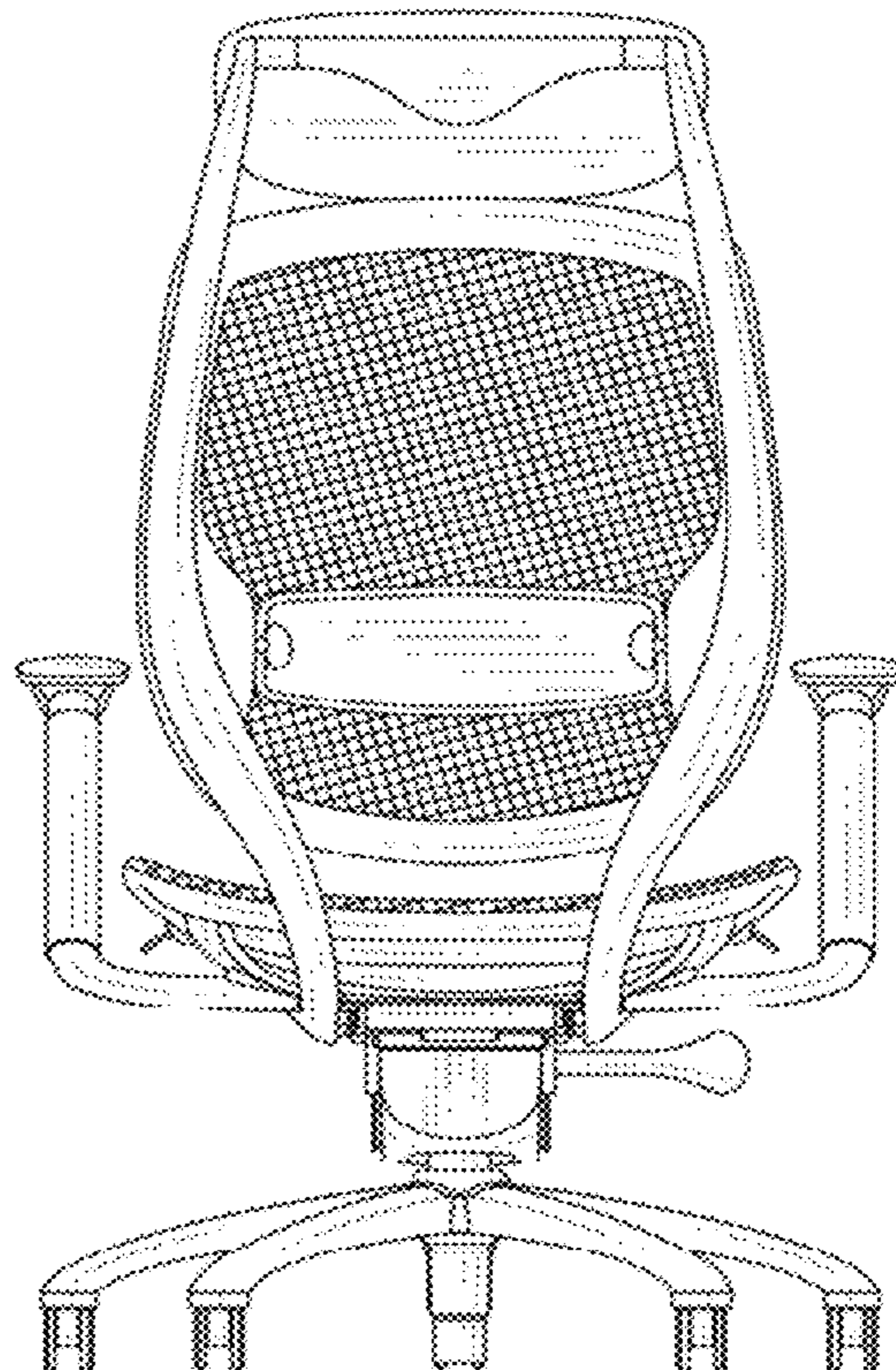
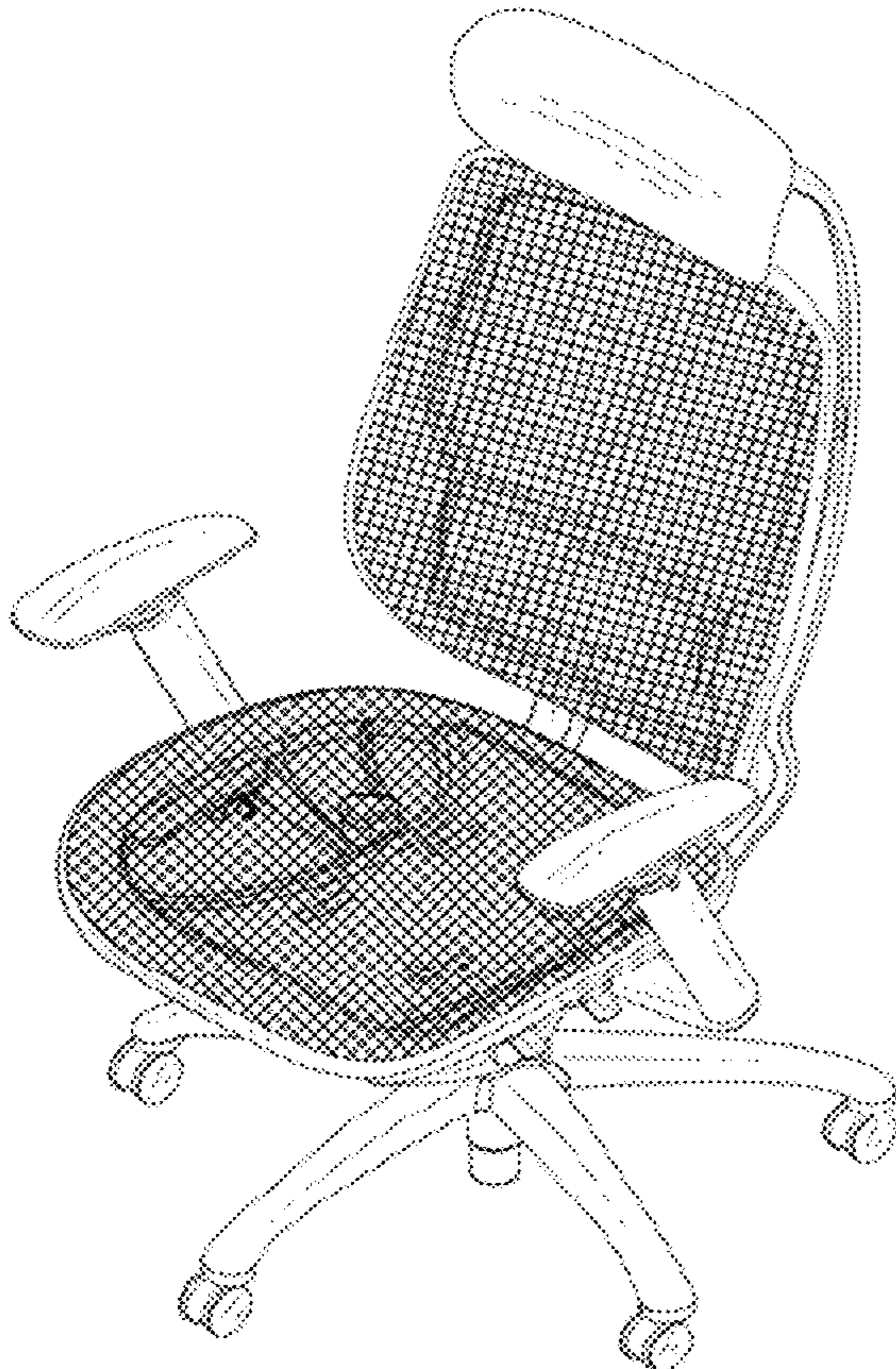



FIG. 1

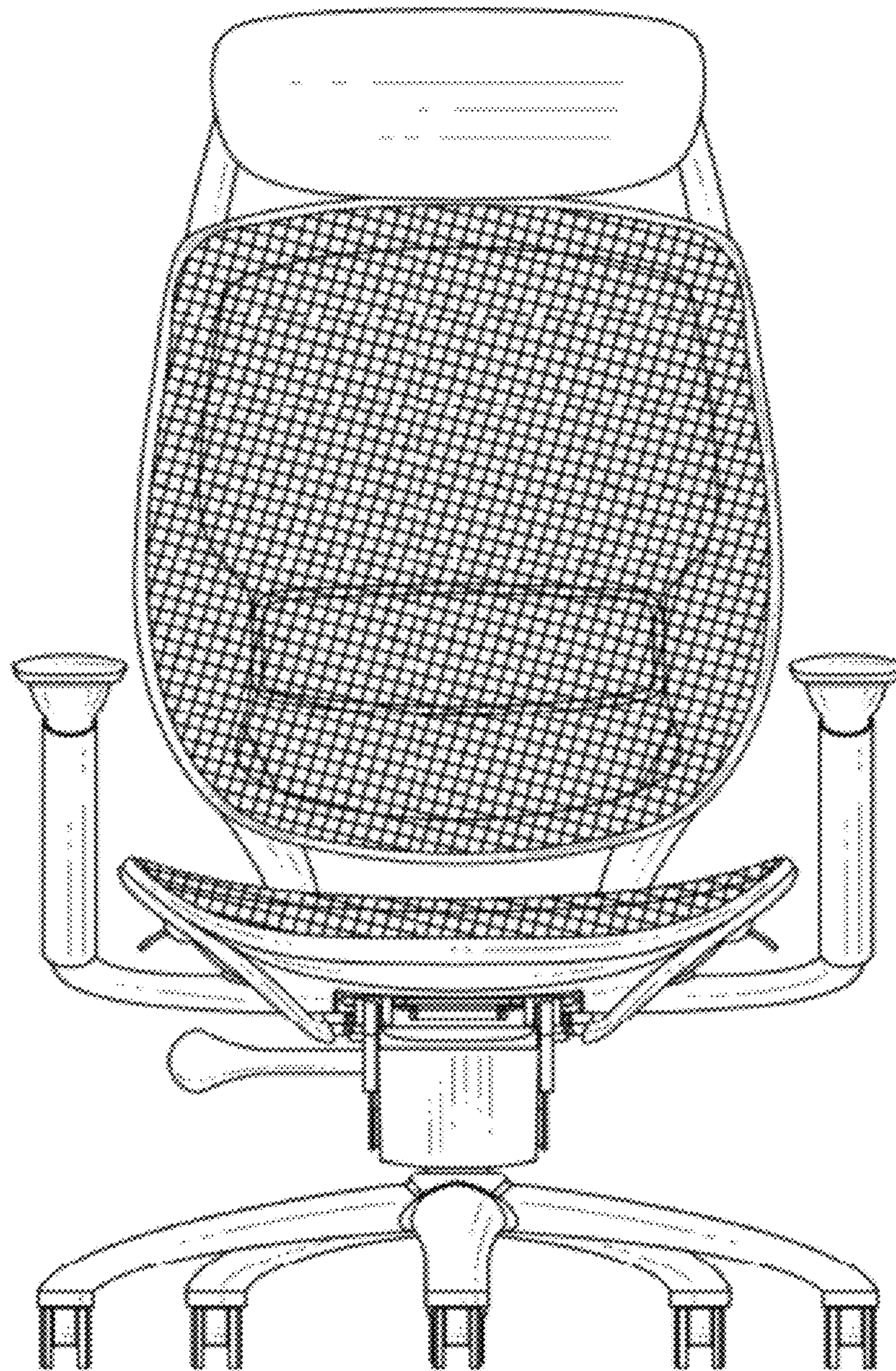

FIG. 2

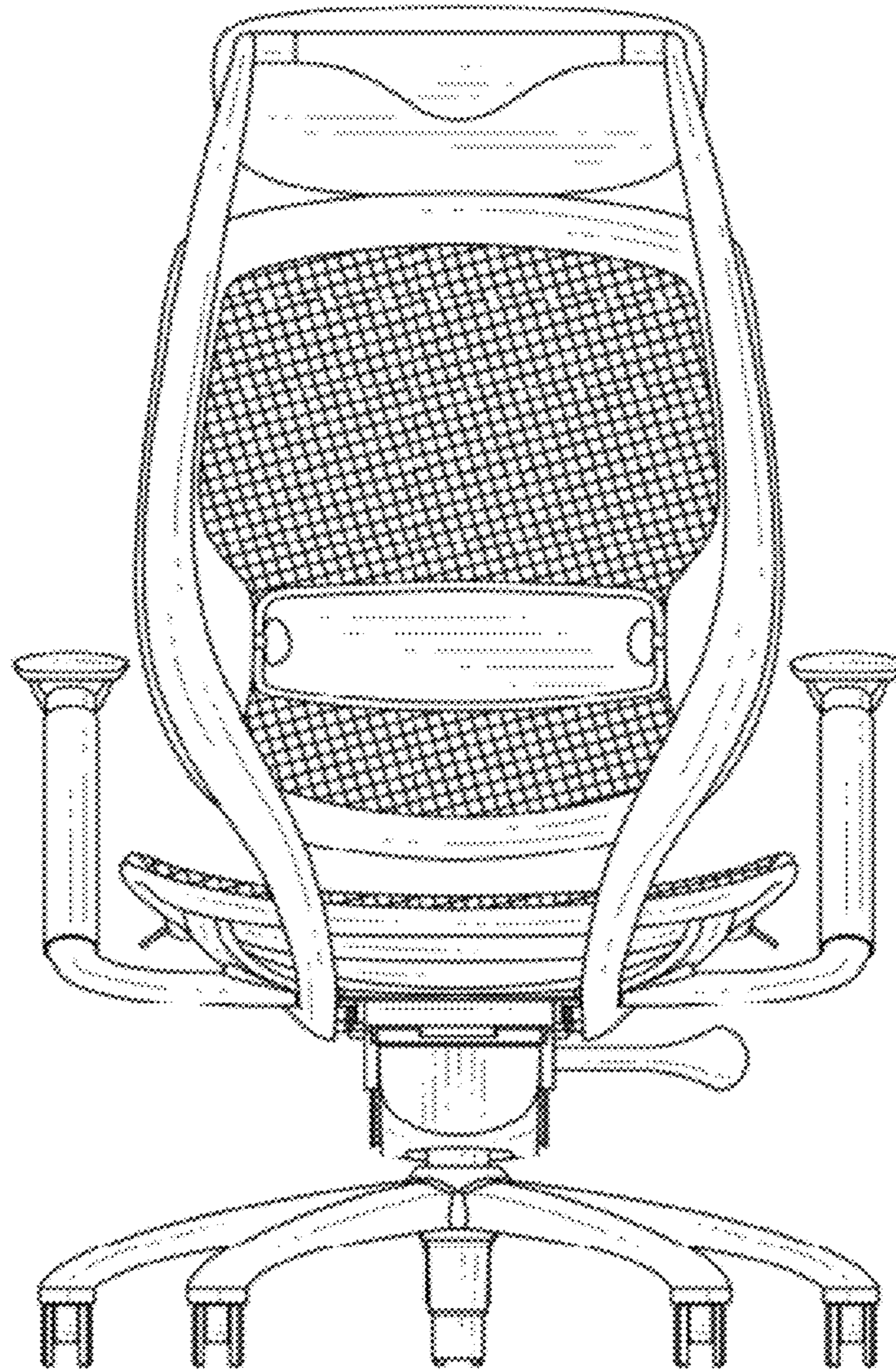

FIG. 3

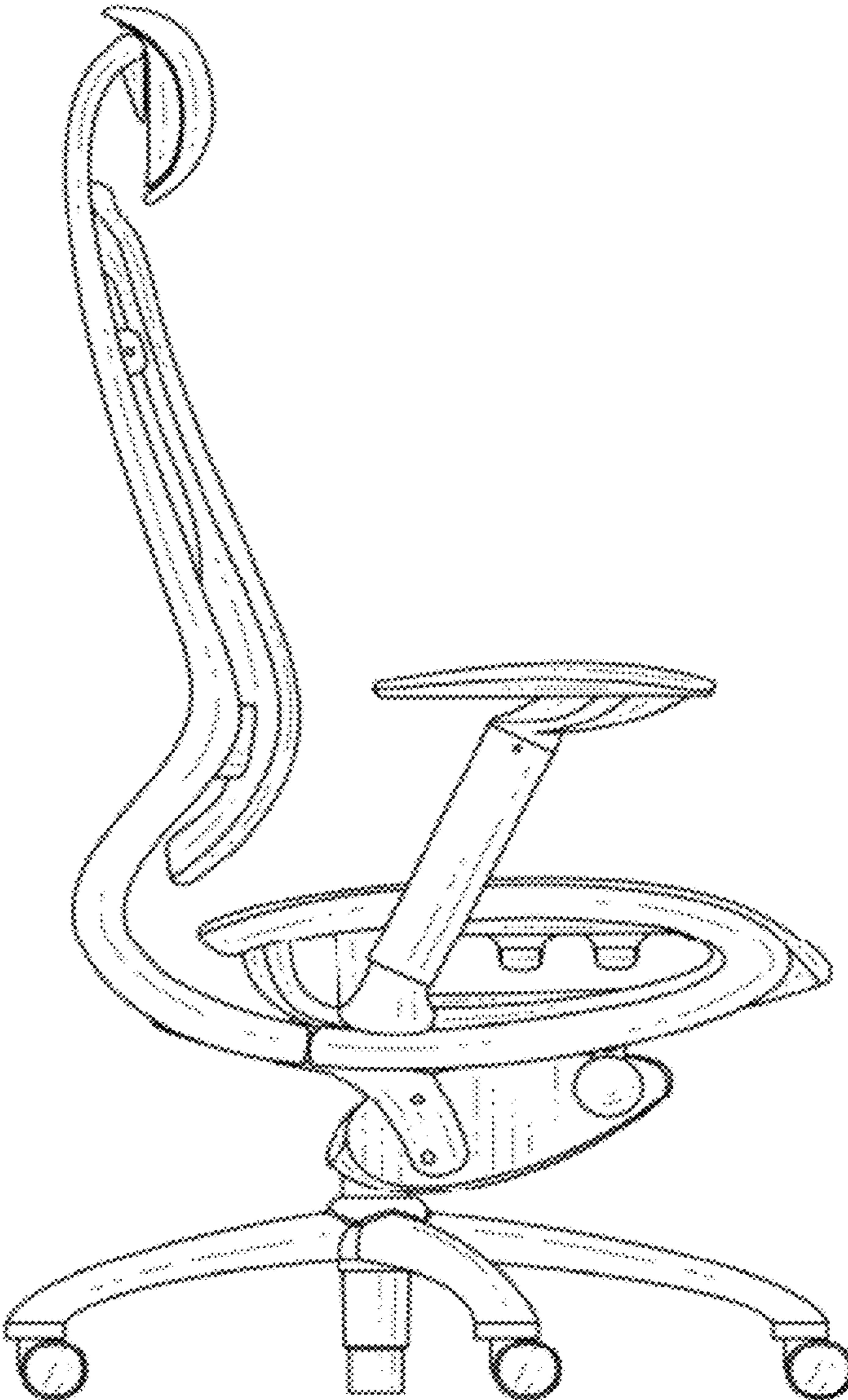

FIG. 4

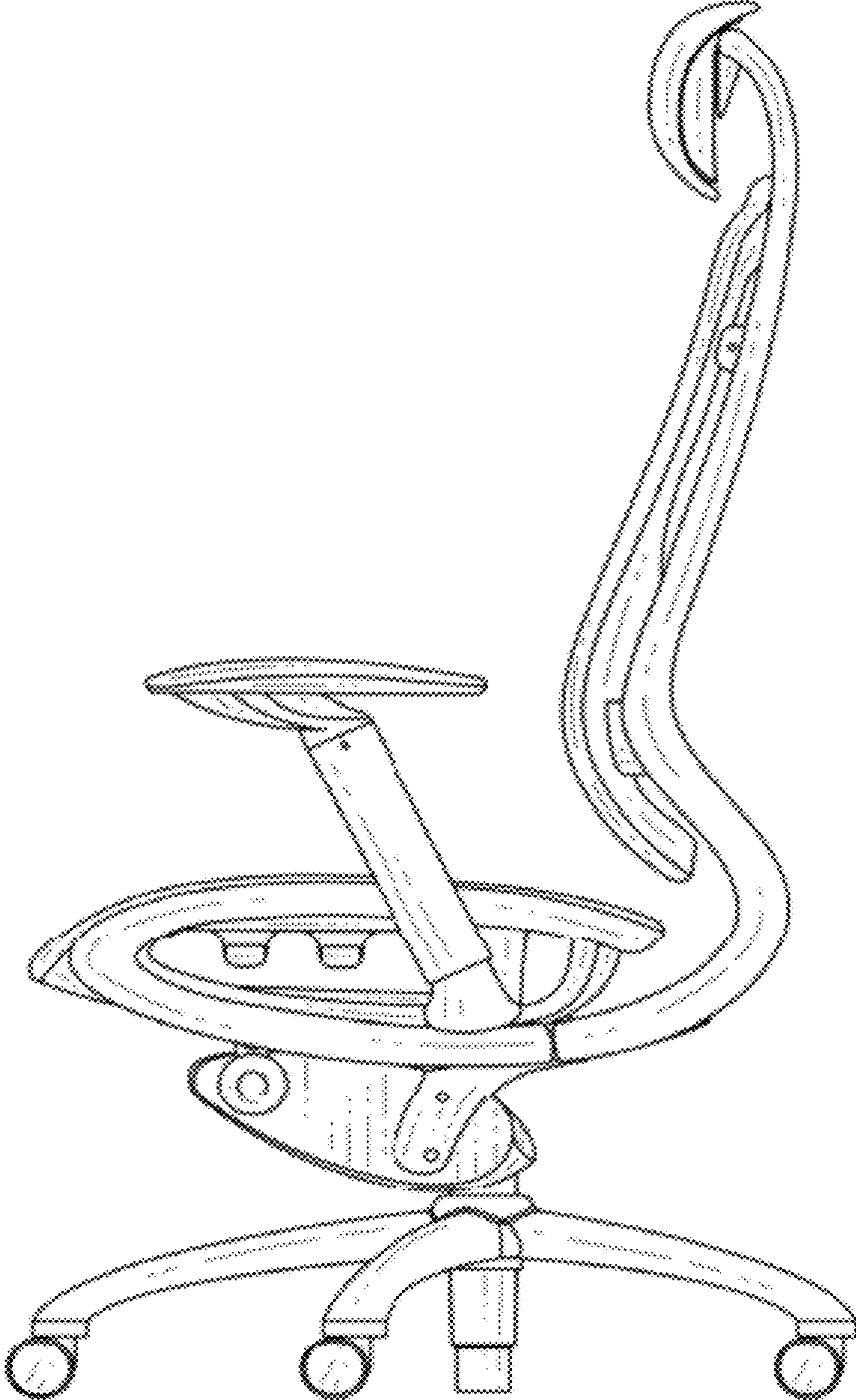

FIG. 5

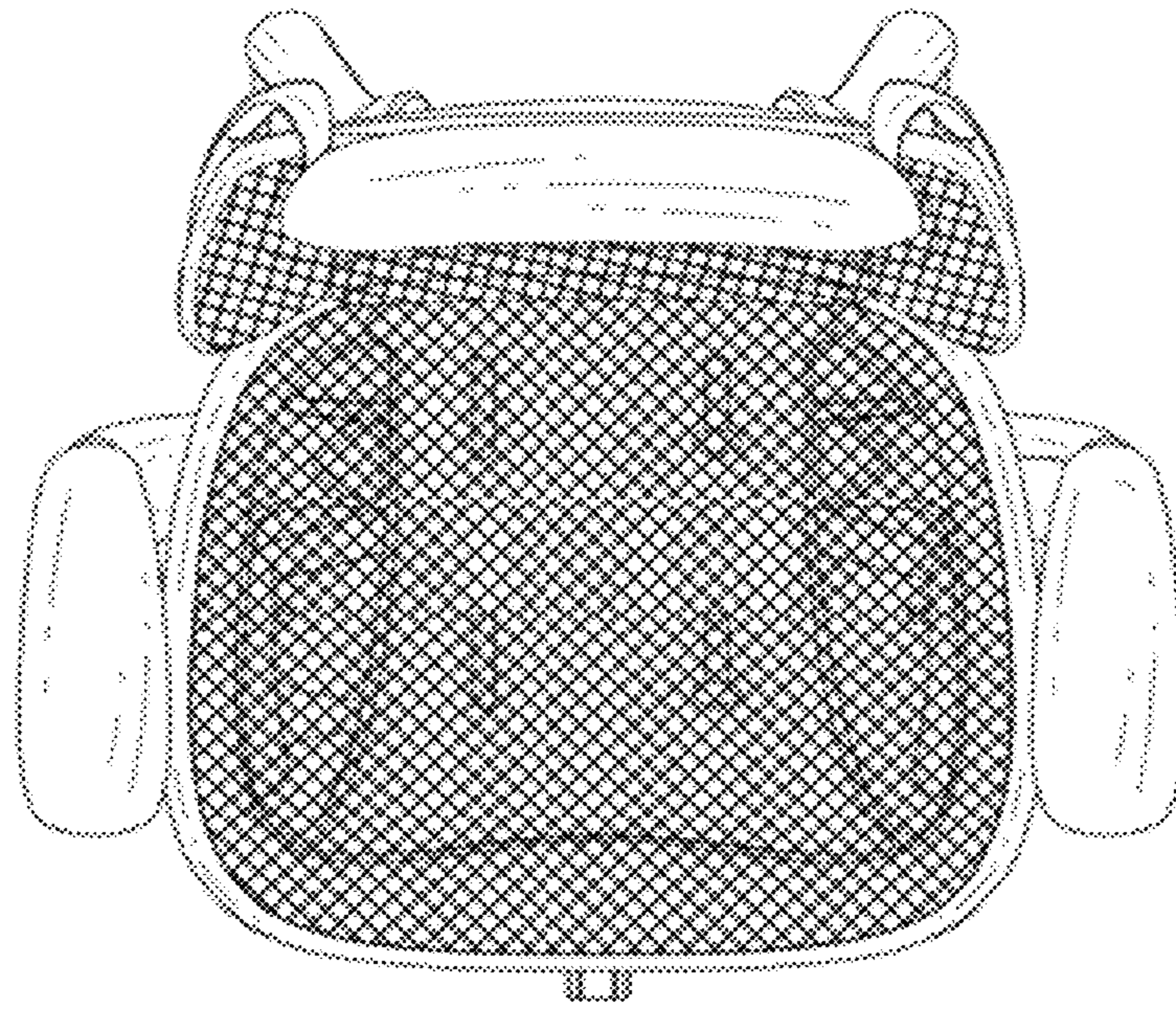

FIG. 6

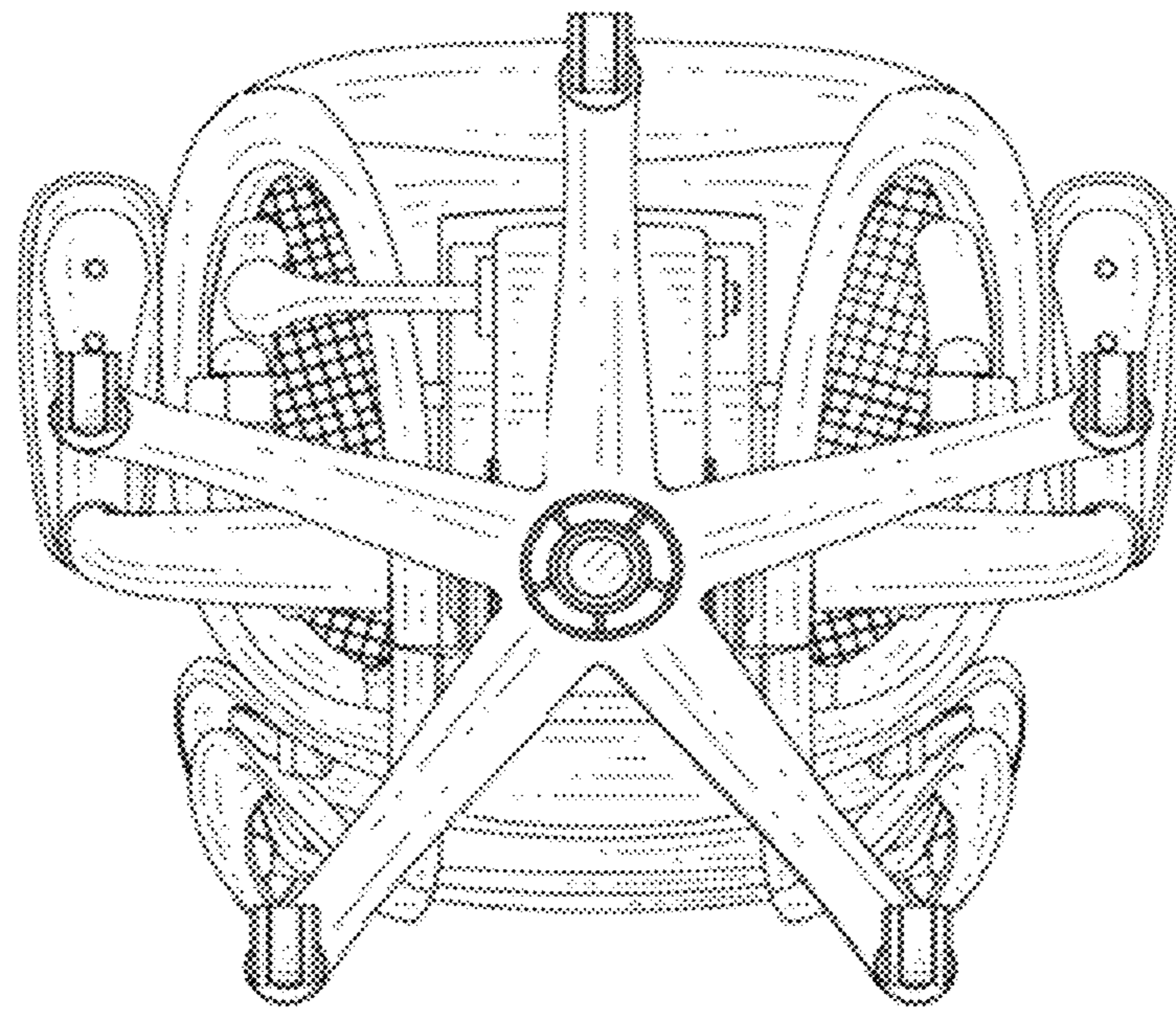

FIG. 7