



US00D658857S

(12) **United States Design Patent**
Lonigan

(10) **Patent No.:** **US D658,857 S**

(45) **Date of Patent:** **** May 8, 2012**

(54) **FOOTWEAR**

(75) **Inventor:** **William Travis Lonigan**, Portland, OR (US)

(73) **Assignee:** **Columbia Sportswear North America, Inc.**, Portland, OR (US)

(**) **Term:** **14 Years**

(21) **Appl. No.:** **29/404,580**

(22) **Filed:** **Oct. 21, 2011**

(51) **LOC (9) Cl.** **02-99**

(52) **U.S. Cl.** **D2/970; D2/911**

(58) **Field of Classification Search** D2/896,
D2/900, 909-911, 920, 943, 946, 969, 970,
D2/974; 36/83, 1.5, 2 R, 109, 3 A, 7.1 R,
36/45, 52, 112, 100

See application file for complete search history.

(56) **References Cited**

U.S. PATENT DOCUMENTS

D354,163 S *	1/1995	Hatfield	D2/970
D364,729 S *	12/1995	Teague	D2/970
D371,898 S *	7/1996	Hatfield	D2/970
D438,698 S *	3/2001	Matis et al.	D2/970

D554,342 S *	11/2007	St. Louis et al.	D2/970
D575,496 S *	8/2008	Roy et al.	D2/970
D575,497 S *	8/2008	Roy et al.	D2/970
D578,296 S *	10/2008	Roy et al.	D2/970

* cited by examiner

Primary Examiner — Robert M Spear

Assistant Examiner — Rashida C McCoy

(74) *Attorney, Agent, or Firm* — Schwabe, Williamson & Wyatt, P.C.

(57) **CLAIM**

I claim the ornamental design for footwear, as shown and described.

DESCRIPTION

FIG. 1 is a perspective view of footwear, showing my new design;

FIG. 2 is a front view thereof;

FIG. 3 is a back view thereof;

FIG. 4 is a left side view thereof;

FIG. 5 is a right side view thereof;

FIG. 6 is a top view thereof; and,

FIG. 7 is a bottom view thereof.

The dashed lines are included for illustrating environmental structure and form no part of the claimed design.

1 Claim, 6 Drawing Sheets



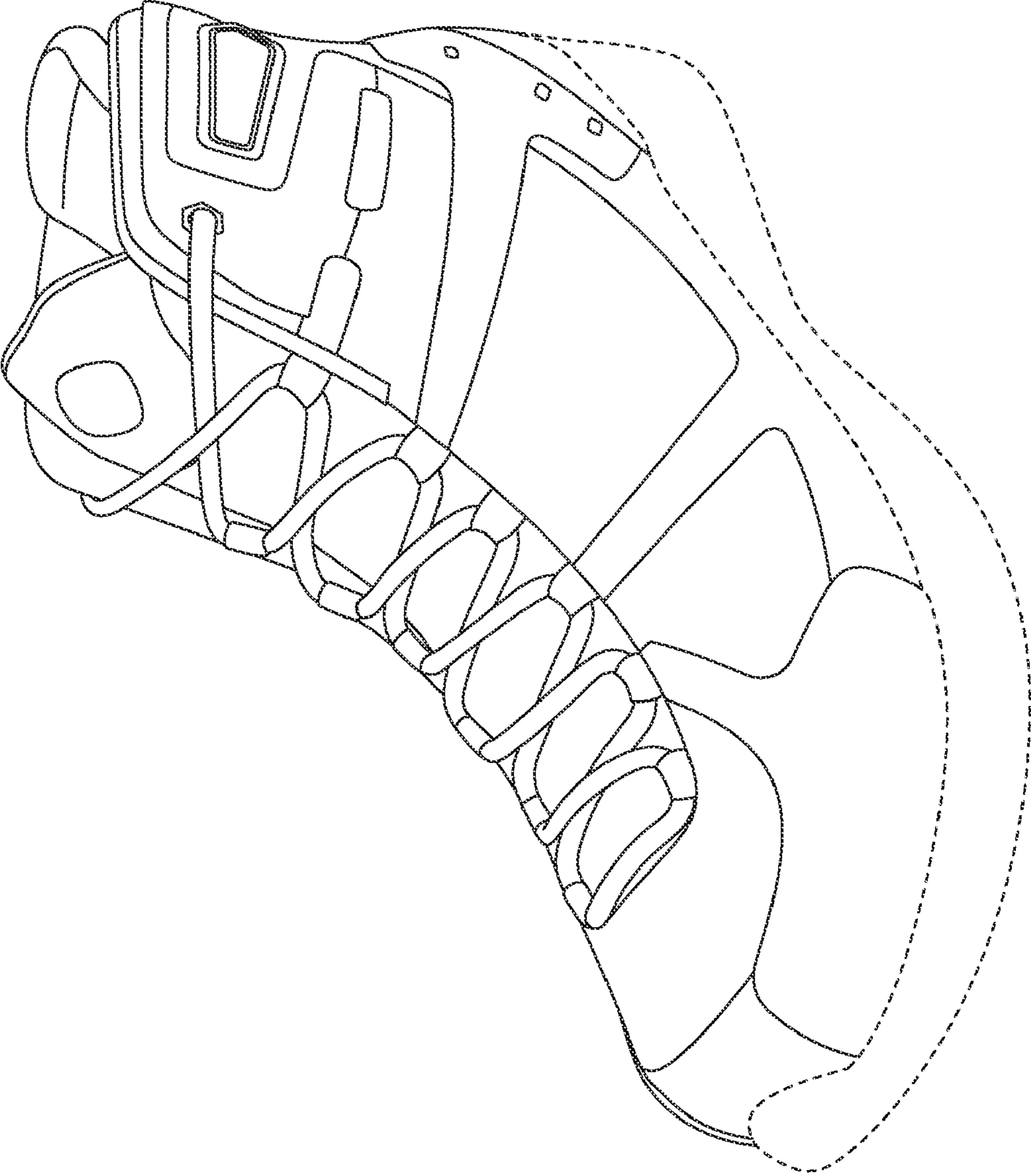

FIG. 1

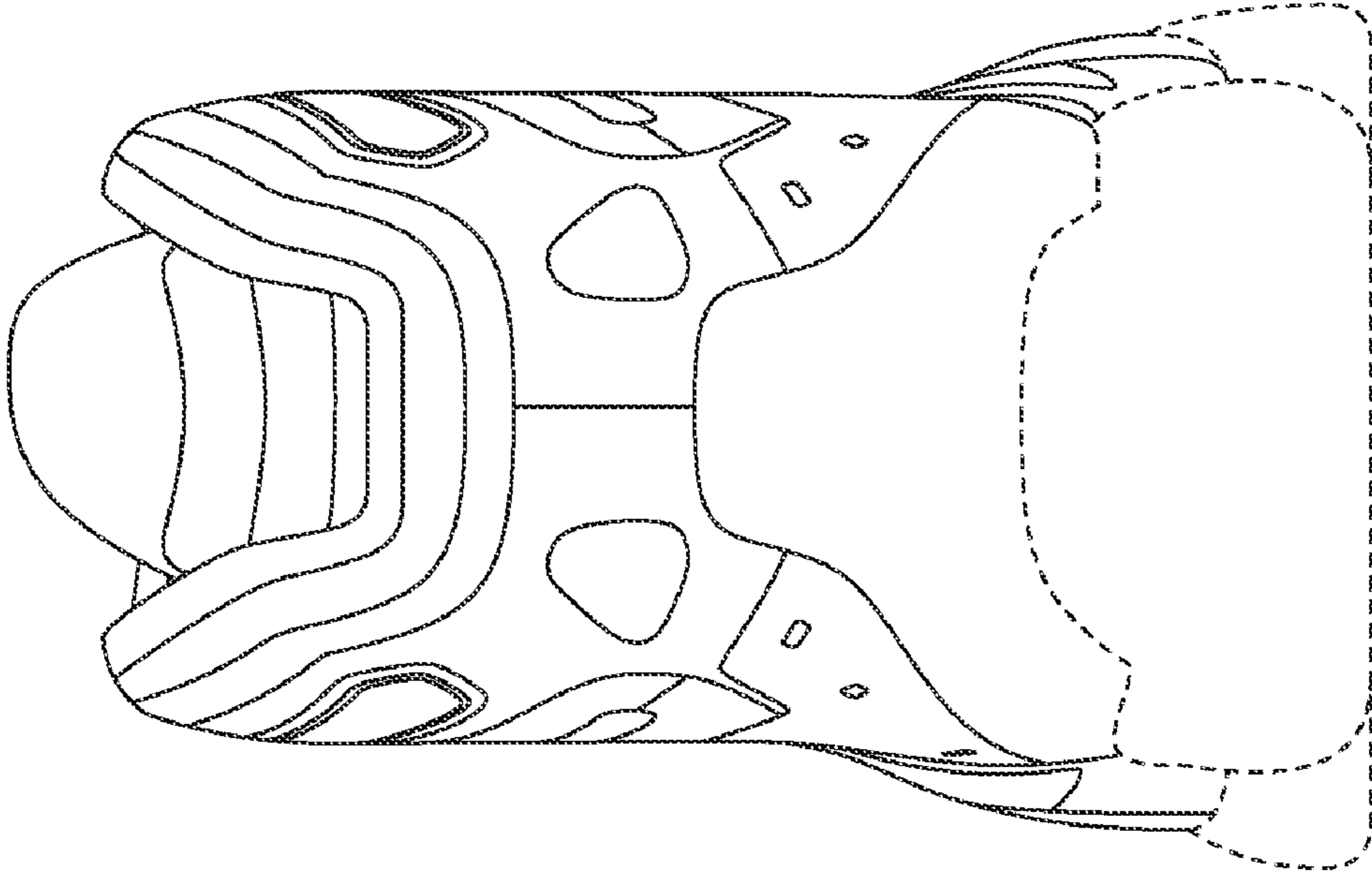

FIG. 3

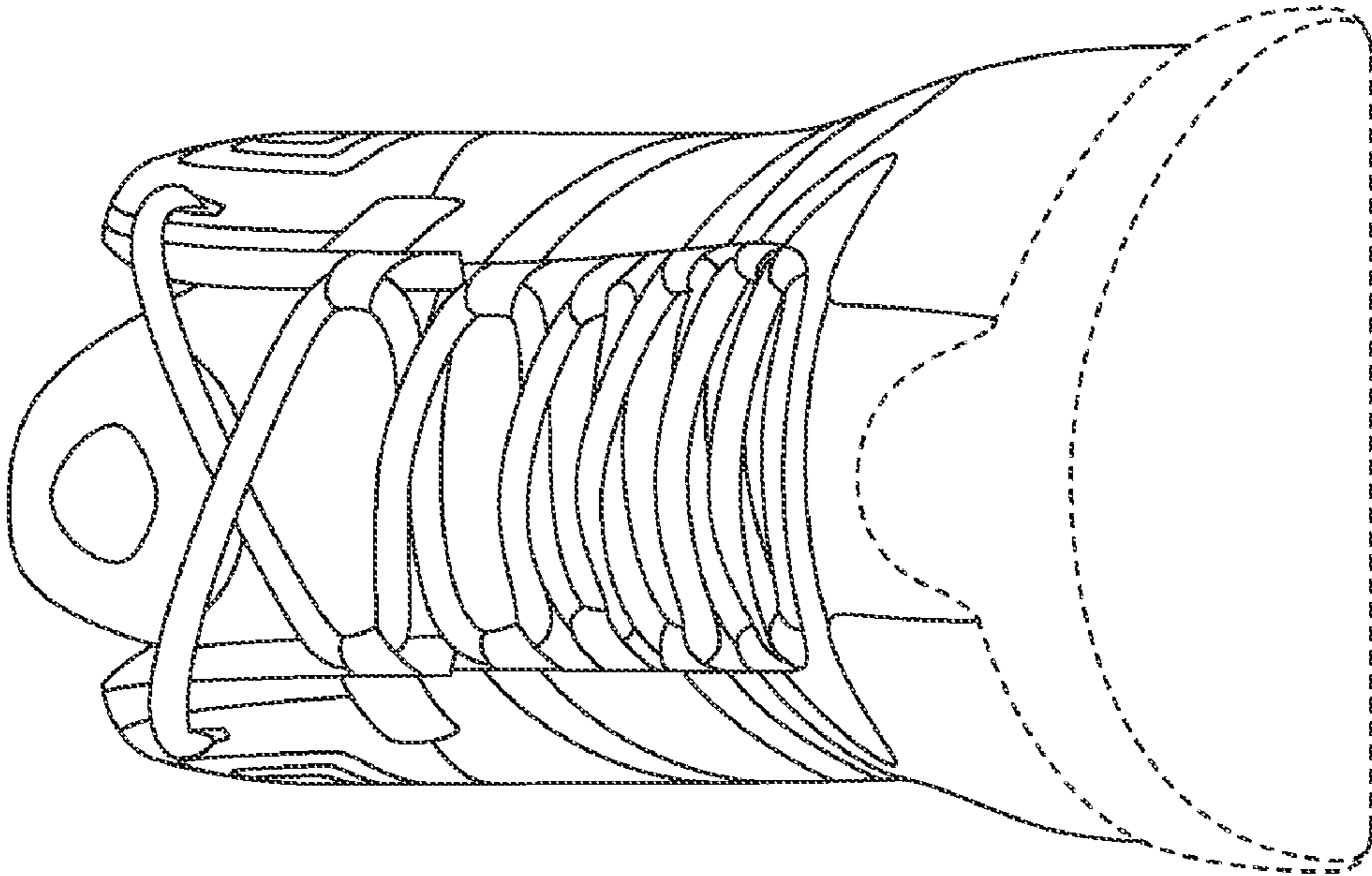

FIG. 2

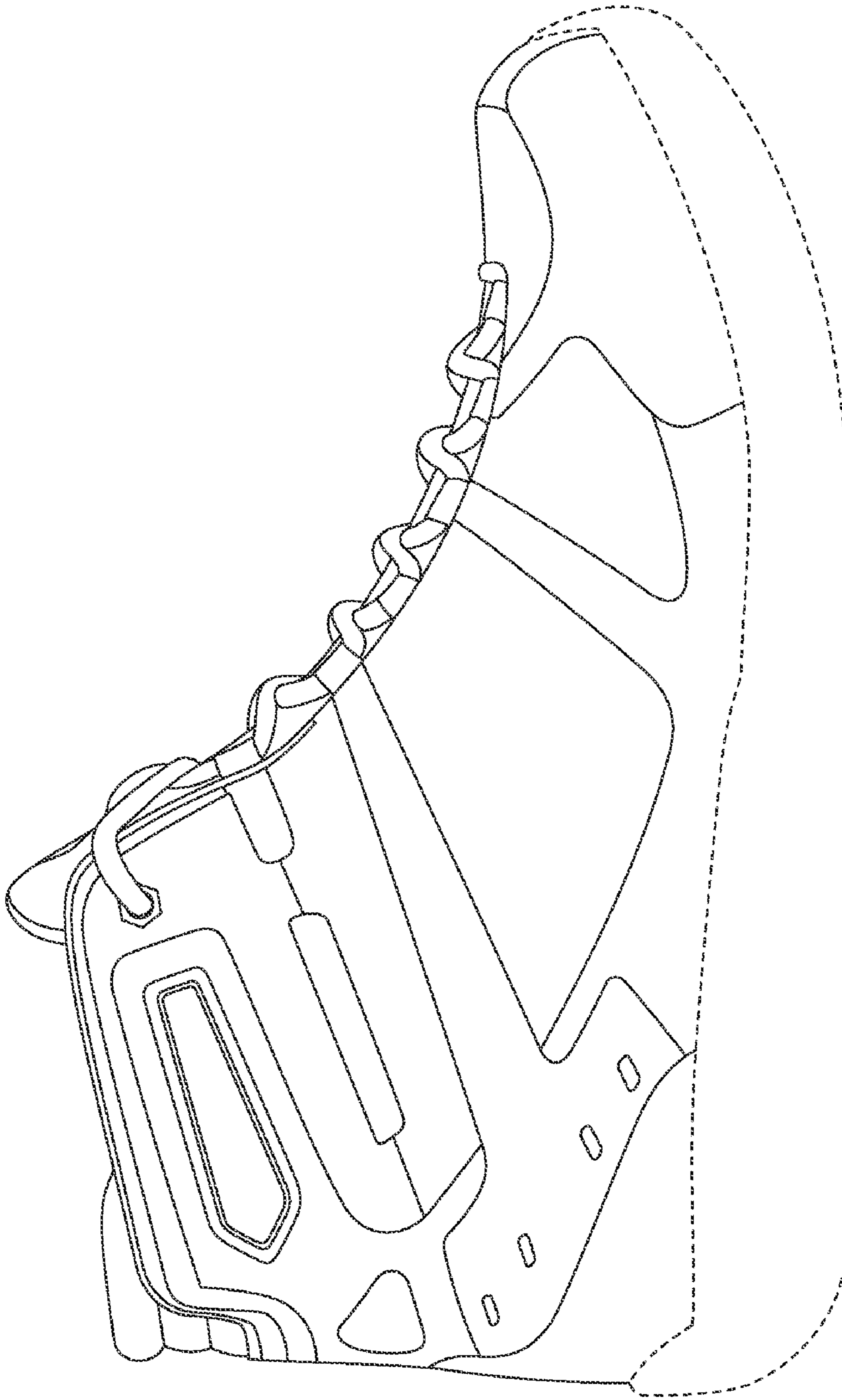

FIG. 4

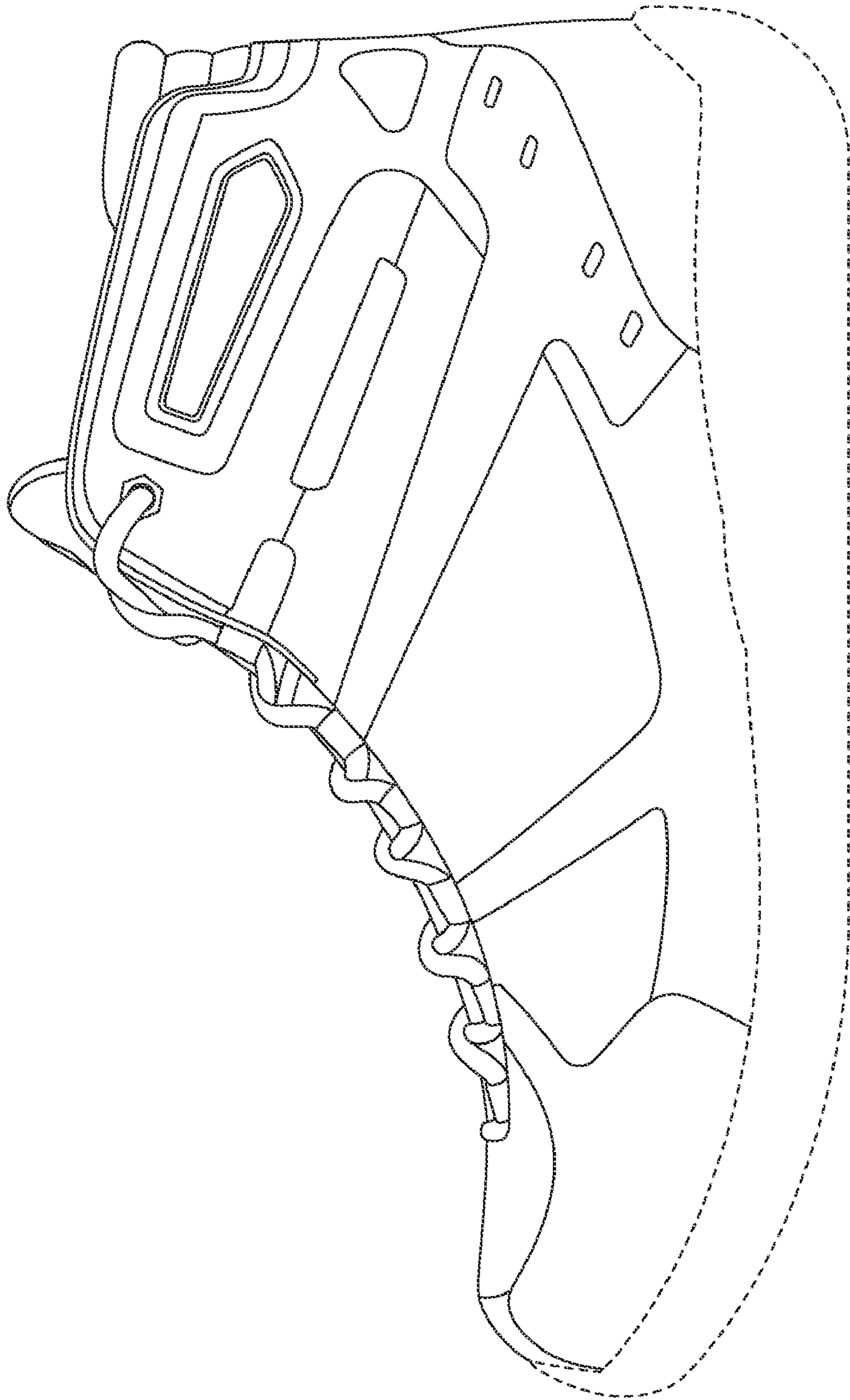

FIG. 5

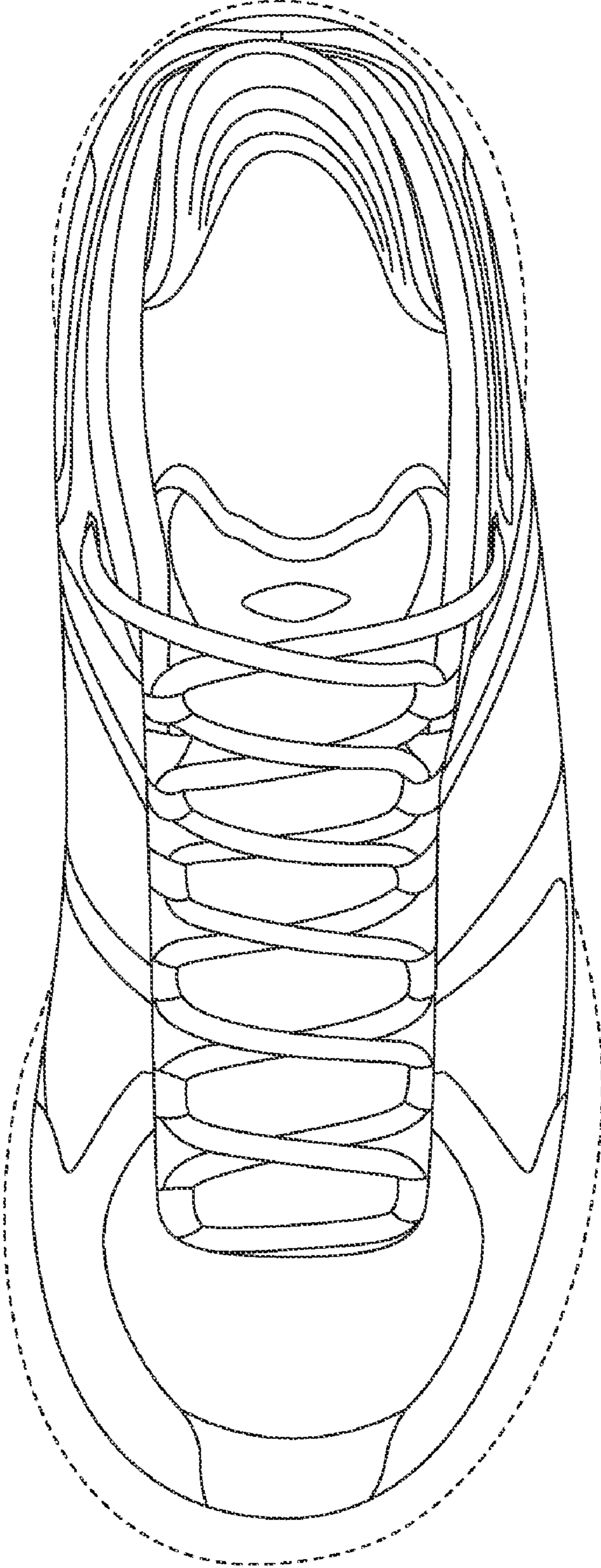

FIG. 6

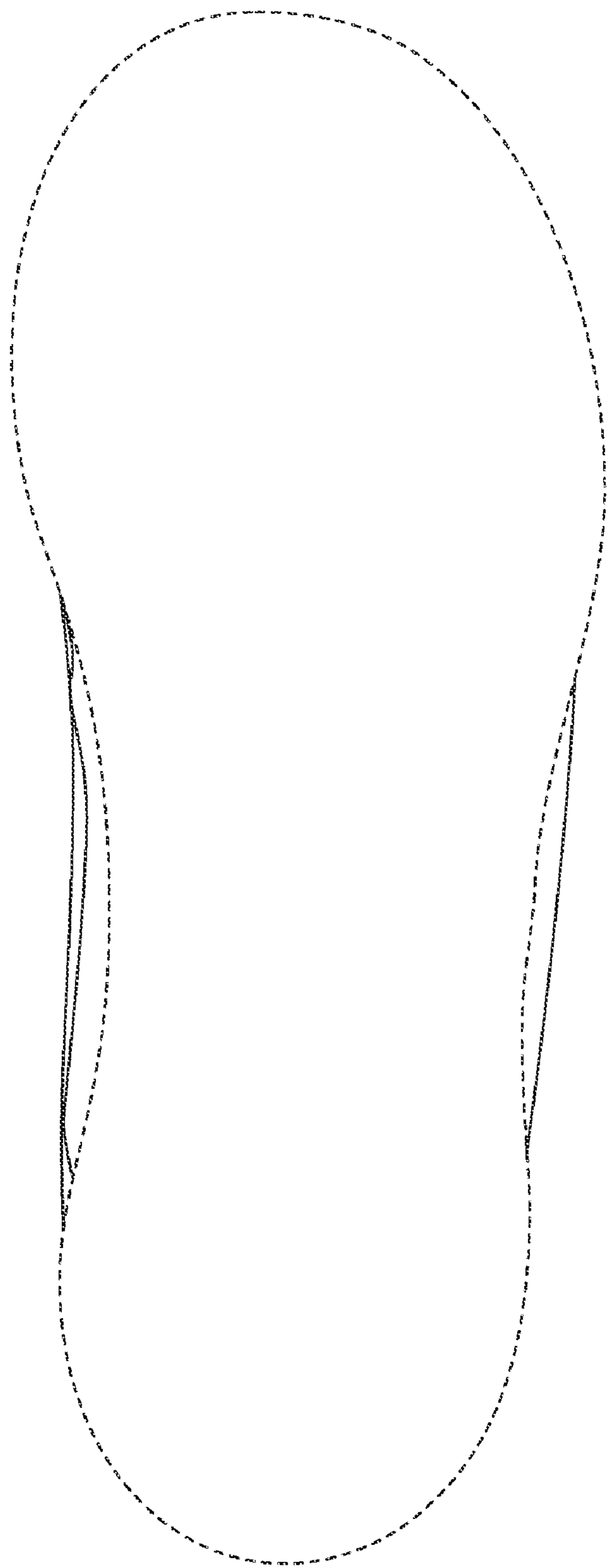

FIG. 7