



US00D658728S

(12) **United States Design Patent**
Warren

(10) **Patent No.:** **US D658,728 S**

(45) **Date of Patent:** **** May 1, 2012**

(54) **DOLL COMPARTMENT**

(76) Inventor: **Qupid Warren**, Oklahoma City, OK
(US)

(**) Term: **14 Years**

(21) Appl. No.: **29/403,716**

(22) Filed: **Oct. 10, 2011**

(51) **LOC (9) Cl.** **21-01**

(52) **U.S. Cl.** **D21/621; D21/630; D21/659**

(58) **Field of Classification Search** D21/621,
D21/623, 624, 625, 628, 630, 631, 633, 640,
D21/643-649, 659; 446/268, 360, 361, 376,
446/379, 382-384; D19/62; D20/23-25

See application file for complete search history.

(56) **References Cited**

U.S. PATENT DOCUMENTS

D415,200 S	*	10/1999	Carpenter et al.	D19/62
D417,702 S	*	12/1999	Carpenter et al.	D19/62
D424,617 S	*	5/2000	Watarai	D19/62
D429,500 S	*	8/2000	Brault et al.	D19/62
D481,770 S	*	11/2003	Choy	D21/659
D508,966 S	*	8/2005	Zehrun	D21/577
D516,463 S	*	3/2006	Thorsteinsson	D11/158
D551,086 S	*	9/2007	Lepoitevin	D9/601
D567,305 S	*	4/2008	Hui	D21/625
D567,306 S	*	4/2008	Hui	D21/625
D590,027 S	*	4/2009	Chia	D21/572
D652,090 S	*	1/2012	Krupp	D21/621

* cited by examiner

Primary Examiner — Zenia Bennett

(74) *Attorney, Agent, or Firm* — James A. Italia; Italia IP

(57) **CLAIM**

The ornamental design for a doll compartment, as shown and described.

DESCRIPTION

FIG. 1 is a perspective view of a valve, showing my new design;
 FIG. 2 is a front elevational view of the doll compartment shown in FIG. 1;
 FIG. 3 is a rear elevational view of the doll compartment shown in FIG. 1;
 FIG. 4 is a left-side elevational view of the doll compartment shown in FIG. 1;
 FIG. 5 is a right-side elevational view of the doll compartment shown in FIG. 1;
 FIG. 6 is a top plan view of the doll compartment shown in FIG. 1;
 FIG. 7 is a bottom plan view of the doll compartment shown in FIG. 1; and,
 FIG. 8 is a perspective view of the doll compartment, shown in its environment.
 The broken lines in the drawing are for illustrative purposes only and form no part of the claimed design.

1 Claim, 5 Drawing Sheets

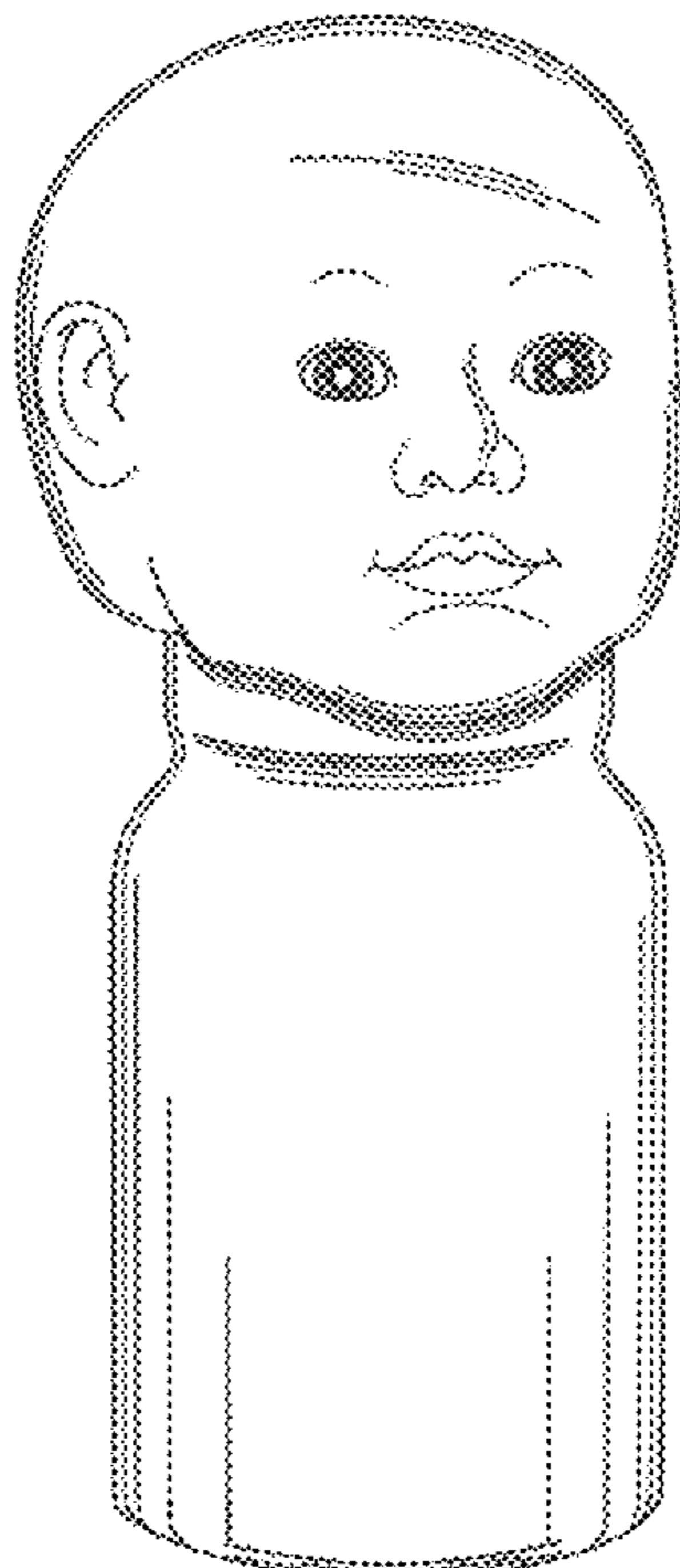

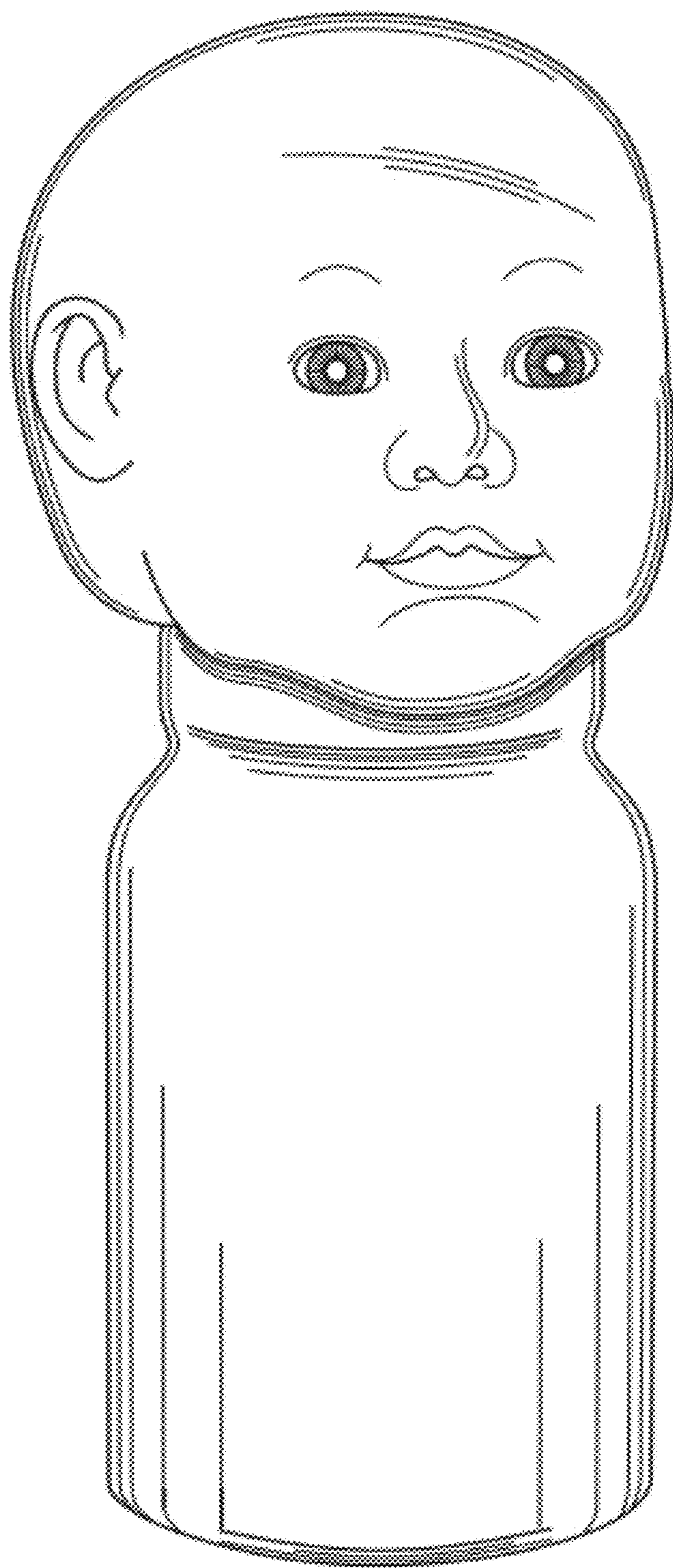

FIG. 1

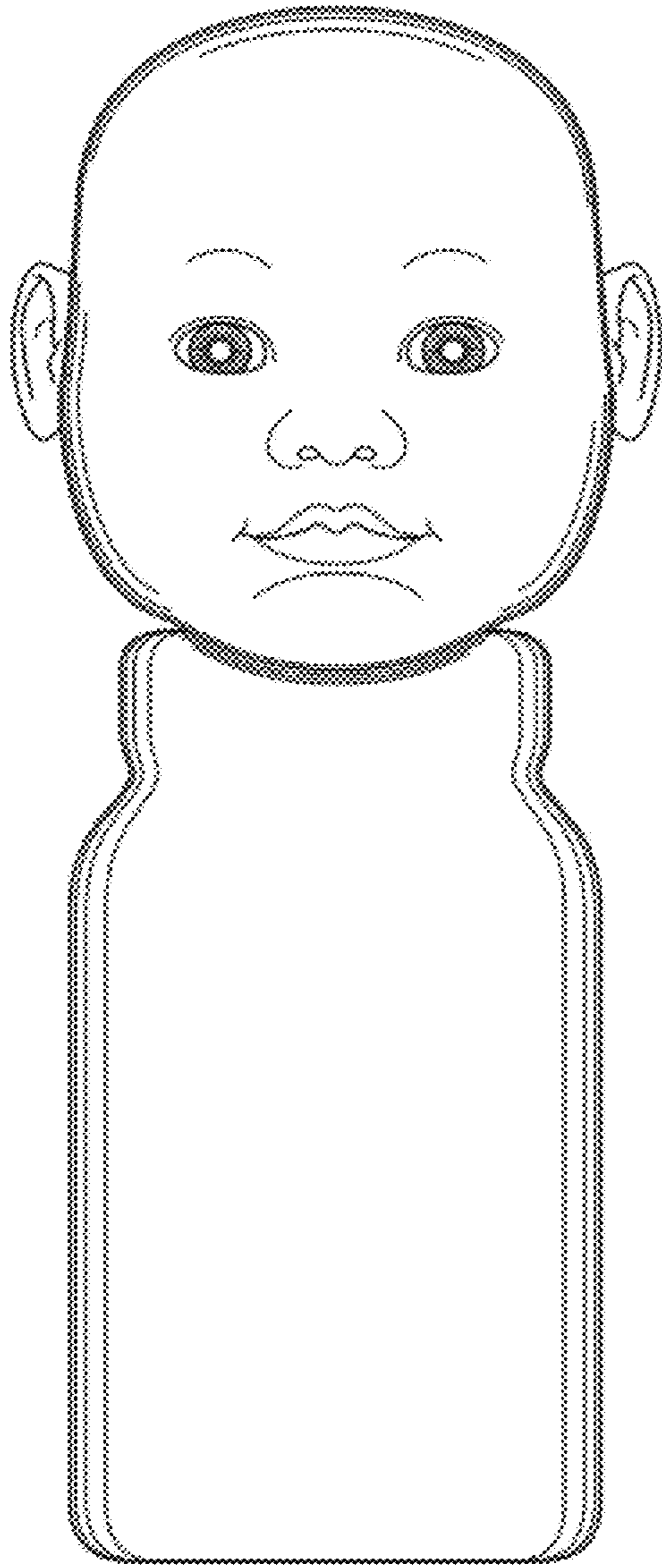

FIG. 2

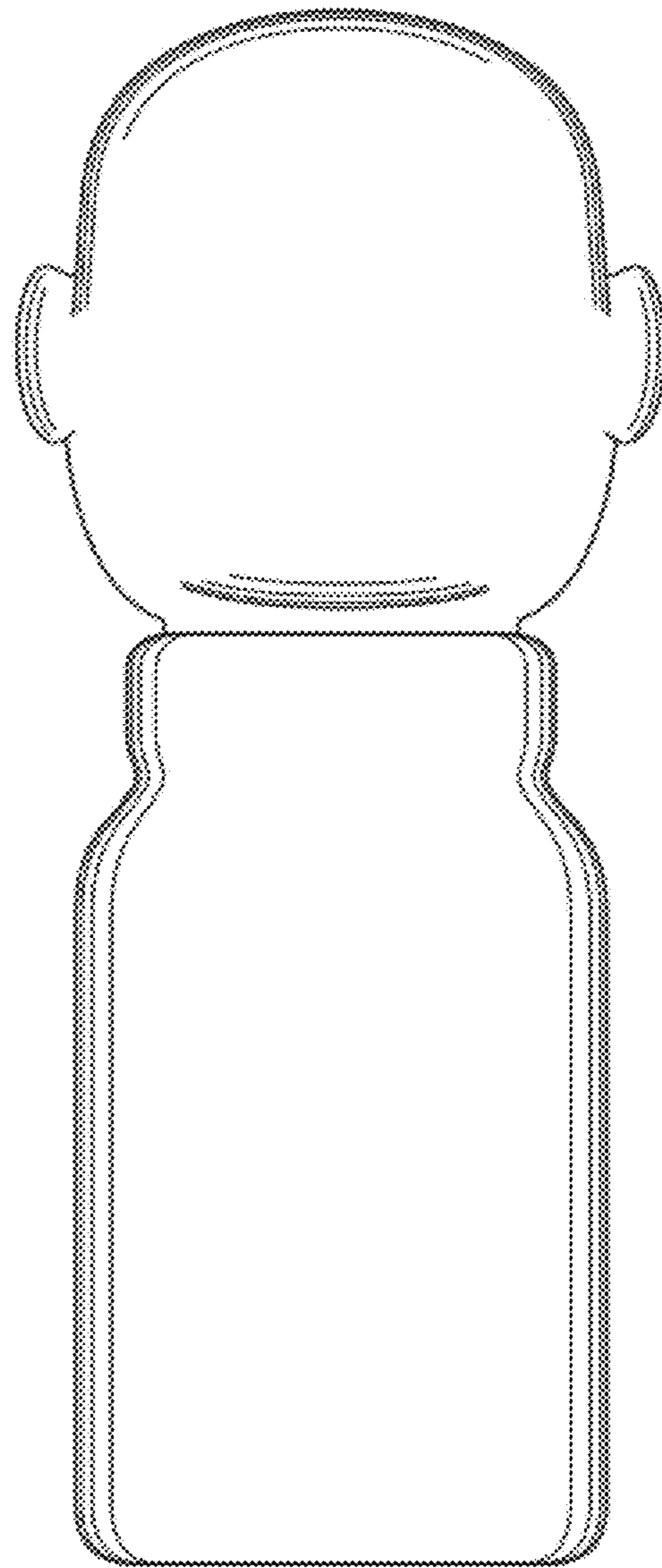

FIG. 3

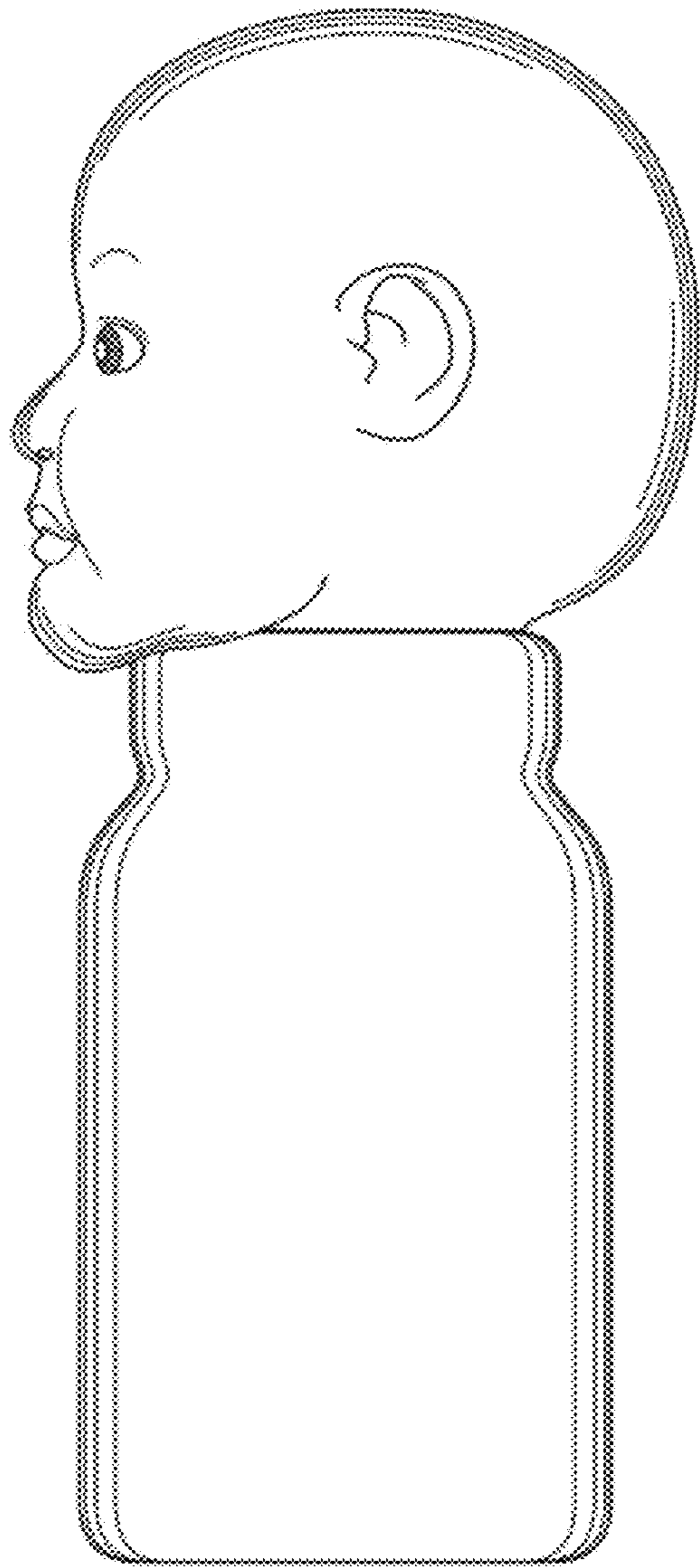

FIG. 4

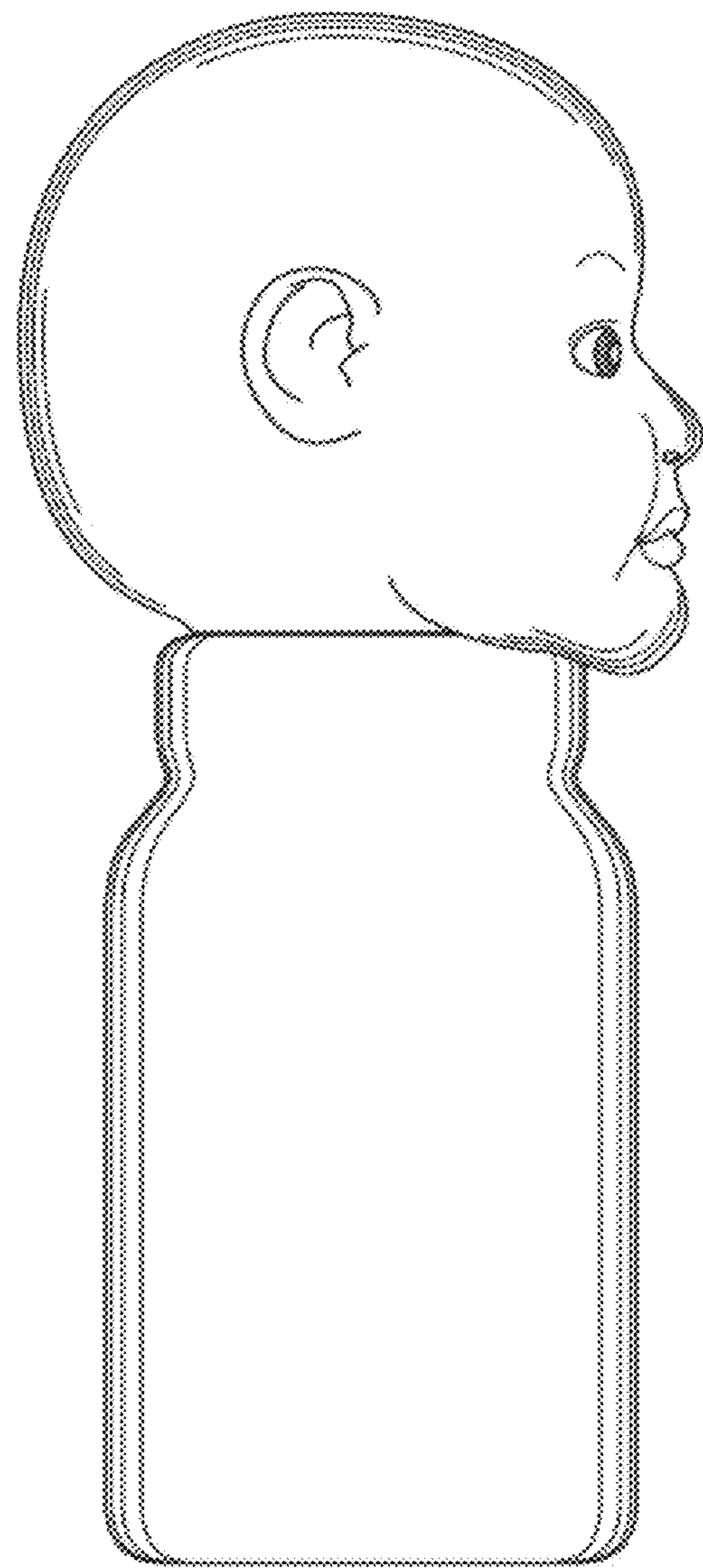

FIG. 5

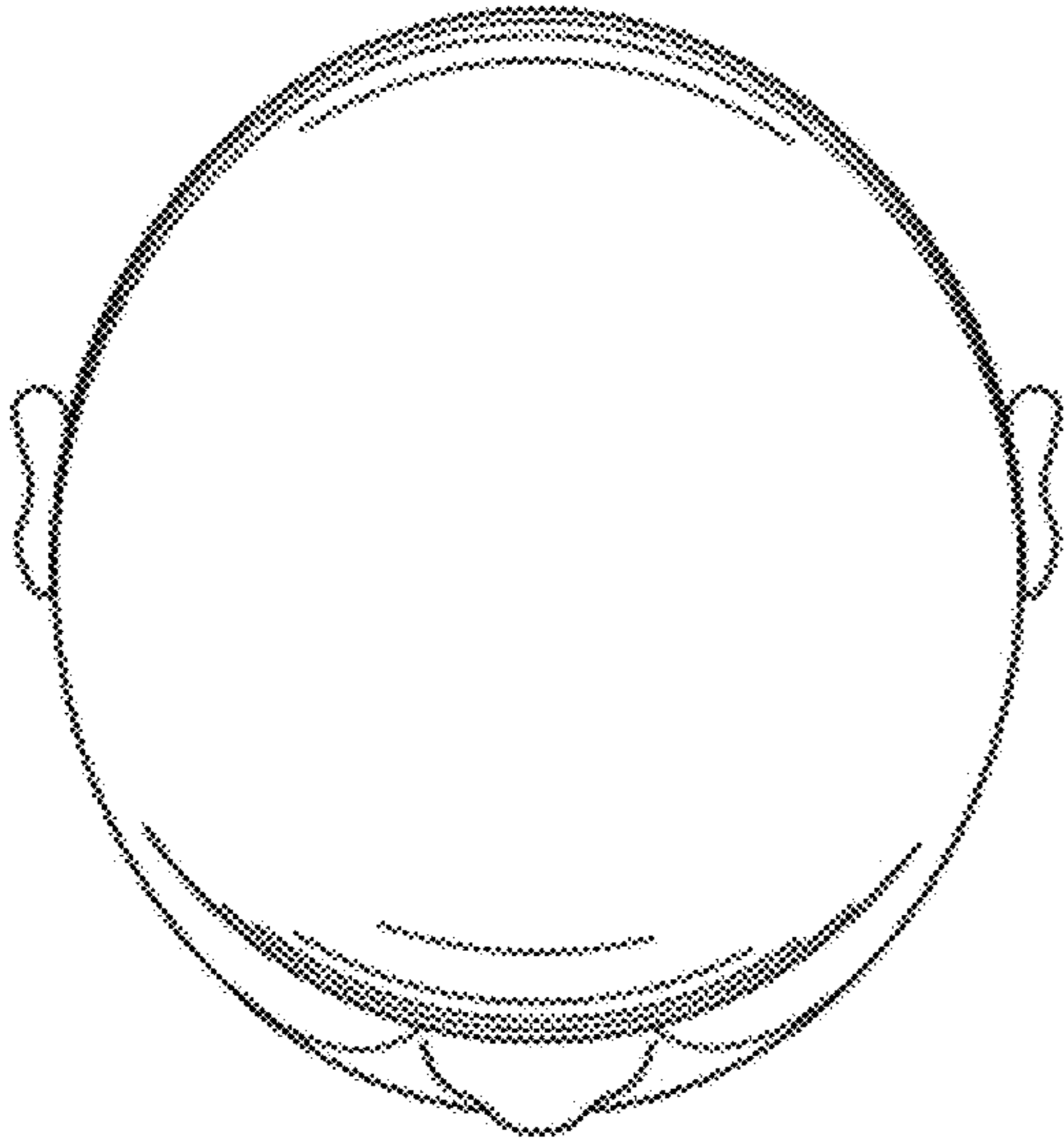

FIG. 6

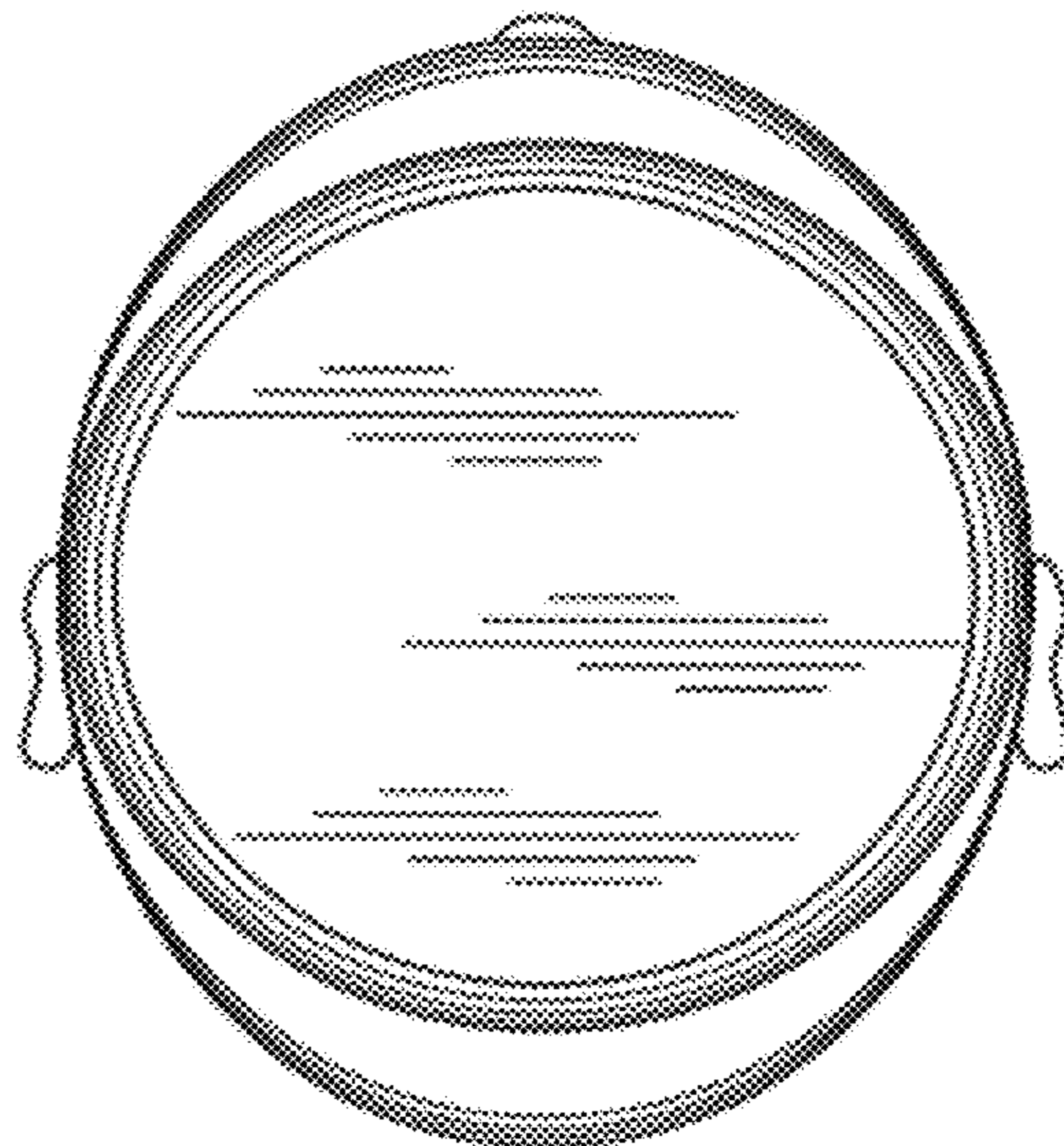

FIG. 7



FIG. 8