



US00D658710S

(12) **United States Design Patent**  
**Mori et al.**

(10) **Patent No.:** **US D658,710 S**

(45) **Date of Patent:** **\*\* May 1, 2012**

(54) **CASH REGISTER**

(75) Inventors: **Tatsuo Mori**, Osaka (JP); **Yuji Hayashihara**, Osaka (JP); **Kenji Ohta**, Osaka (JP)

(73) Assignee: **Sharp Kabushiki Kaisha**, Osaka (JP)

(\*\*) Term: **14 Years**

(21) Appl. No.: **29/394,196**

(22) Filed: **Jun. 14, 2011**

(30) **Foreign Application Priority Data**

Dec. 15, 2010 (JP) ..... 2010-029853

(51) **LOC (9) Cl.** ..... **18-01**

(52) **U.S. Cl.** ..... **D18/4.3**

(58) **Field of Classification Search** ..... D14/336,  
D14/371-376, 387; D18/3.1-3.3, 4.1-4.6,  
D18/6-8, 11, 12, 12.1-12.3; D21/324, 329,  
D21/332; D99/28, 34-36, 43; 235/1 E, 2,  
235/7 R, 12, 22, 33, 51, 52; 705/12, 15-18,  
705/43

See application file for complete search history.

(56) **References Cited**

**U.S. PATENT DOCUMENTS**

D245,809 S	9/1977	Kitai	
D247,388 S	2/1978	Kurozumi	
D247,587 S	3/1978	Sakamoto	
D255,126 S *	5/1980	Ohie et al.	..... D18/7
D260,099 S	8/1981	Sakamoto	
D260,100 S	8/1981	Sakamoto	
D261,003 S	9/1981	Jinbo et al.	
D261,004 S	9/1981	Jinbo et al.	
D276,919 S	12/1984	Sakamoto et al.	
D277,107 S	1/1985	Sakamoto	
D283,822 S	5/1986	Ishida	
D294,364 S	2/1988	Nishibori et al.	
D294,365 S	2/1988	Nishibori et al.	
D301,588 S	6/1989	Kosako	
D301,589 S	6/1989	Makidera	

D301,894 S	6/1989	Tsukada et al.	
D302,023 S	7/1989	Makidera	
D303,395 S	9/1989	Tsukada et al.	
D303,806 S *	10/1989	Kato et al.	..... D18/4.3
D314,970 S	2/1991	Tomioke	
D319,251 S	8/1991	Ishida et al.	
D321,706 S *	11/1991	Yamamoto	..... D18/4.5
D330,906 S	11/1992	Kawaishi et al.	
D330,908 S	11/1992	Kawaishi et al.	
D331,417 S	12/1992	Kawaishi et al.	
D333,147 S	2/1993	Miyake et al.	
D338,877 S *	8/1993	Savio	..... D18/4.5
D351,402 S *	10/1994	Tamura et al.	..... D18/4.5
D353,613 S	12/1994	Miyake et al.	
D354,976 S	1/1995	Miyake et al.	
D354,977 S	1/1995	Miyake et al.	
D372,042 S	7/1996	Hokazono	
D372,043 S	7/1996	Hokazono	
D379,366 S	5/1997	Hokazono	
D391,601 S	3/1998	Kanaoka	

(Continued)

*Primary Examiner* — Garth Rademaker

(74) *Attorney, Agent, or Firm* — Nixon & Vanderhye, P.C.

(57) **CLAIM**

The ornamental design for a “cash register,” as shown and described.

**DESCRIPTION**

FIG. 1 is a top, right, front perspective view of a cash register in accordance with our new design; FIG. 2 is a front elevation view thereof; FIG. 3 is a rear elevation view thereof; FIG. 4 is a top plan view thereof; FIG. 5 is a bottom plan view thereof; FIG. 6 is a right side elevation view thereof; FIG. 7 is a left side elevation view thereof; and, FIG. 8 is a top, right, front perspective view thereof, shown with the LCD display folded down and the customer display pulled out. The broken lines depict environmental subject matter only and form no part of the claimed design.

**1 Claim, 8 Drawing Sheets**

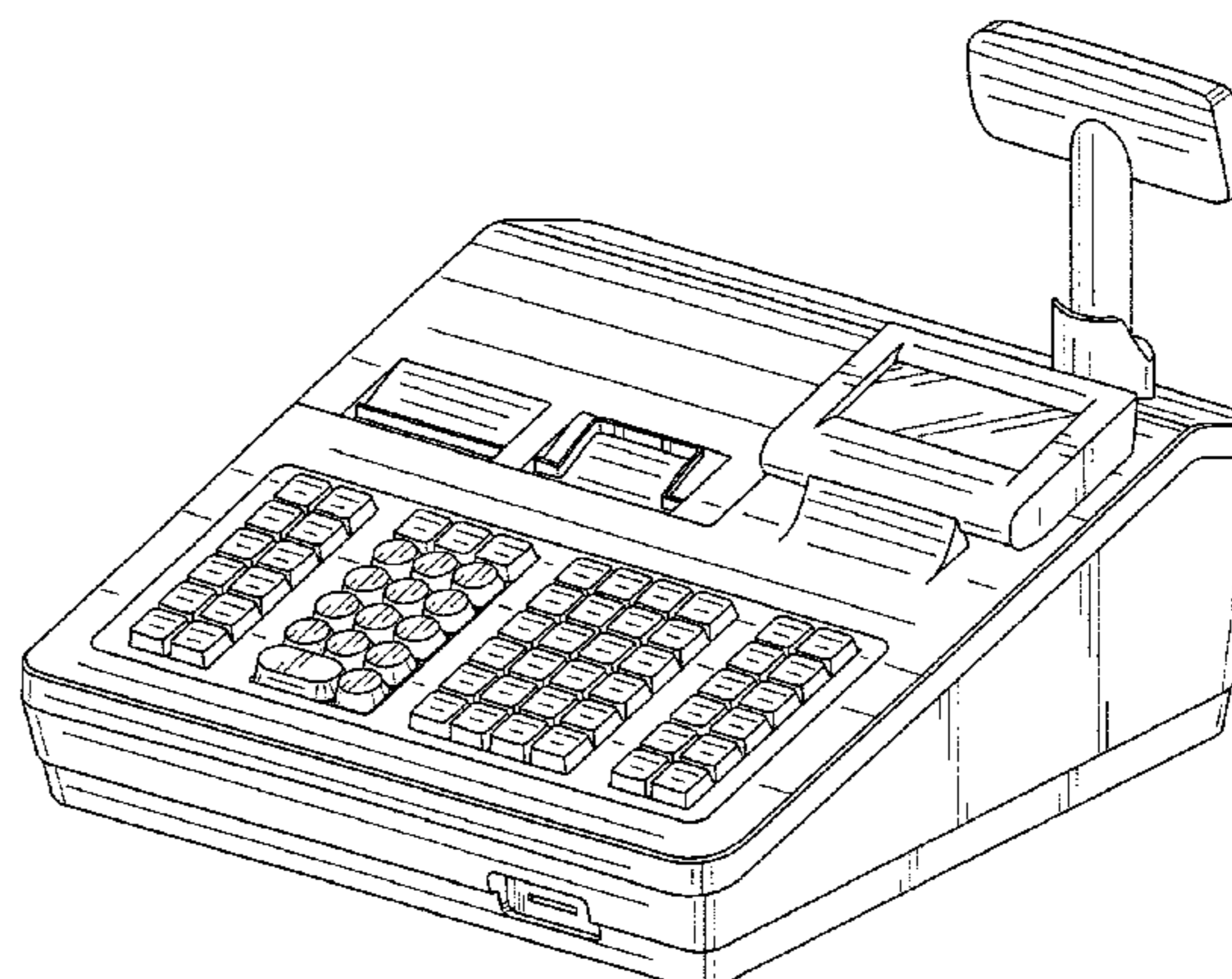
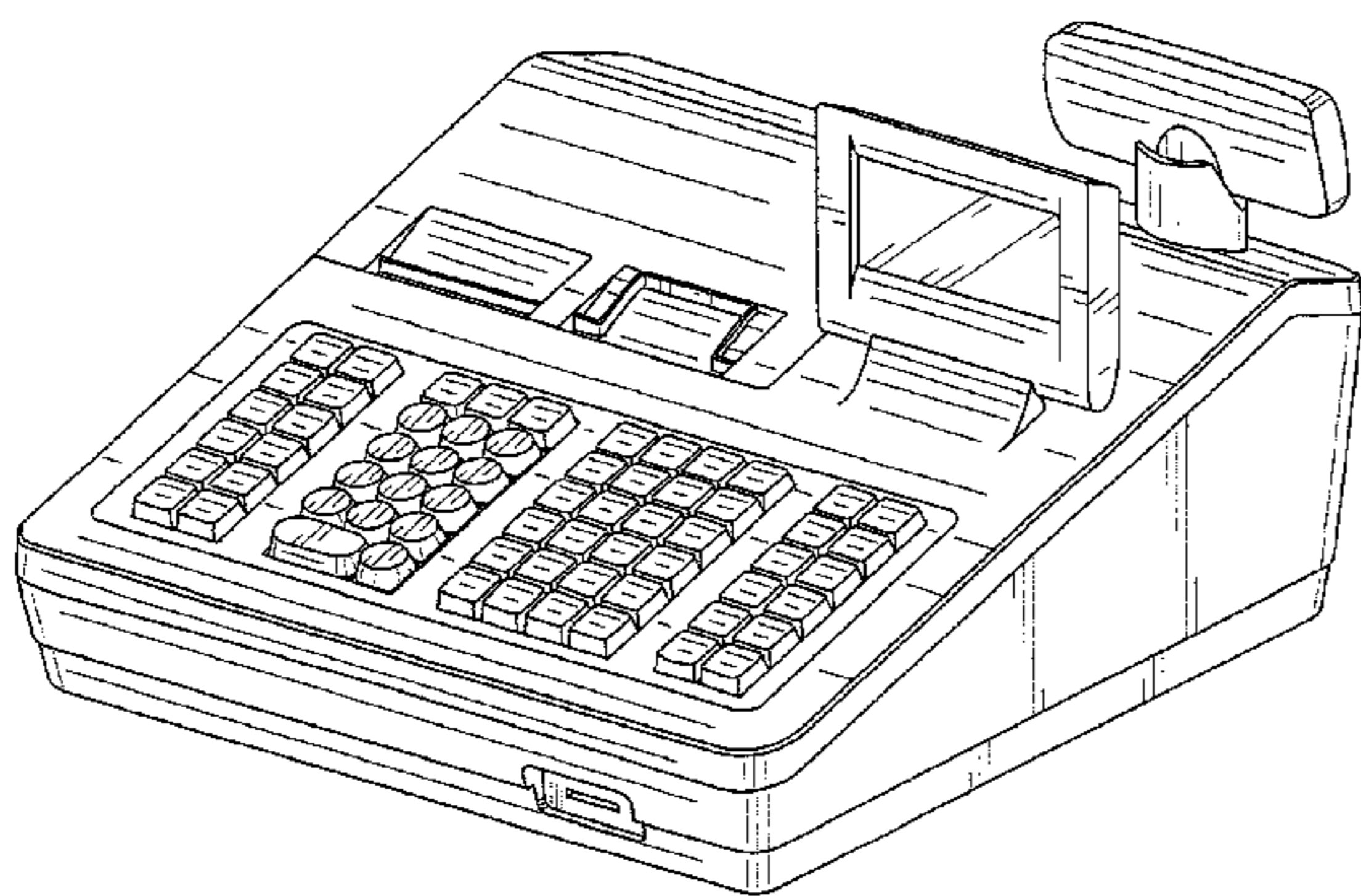

# US D658,710 S

Page 2

---

## U.S. PATENT DOCUMENTS

D397,719 S	*	9/1998	Masuda .....	D18/4.1	D468,761 S		1/2003	Mizusugi	
D417,692 S		12/1999	Mizusugi et al.		D469,118 S	*	1/2003	Yugaya .....	D18/4.1
D433,053 S		10/2000	Mizusugi		D537,864 S		3/2007	Ohta	
D466,548 S		12/2002	Yamashiro		D570,400 S		6/2008	Ohta	
D466,549 S		12/2002	Mizusugi						

\* cited by examiner

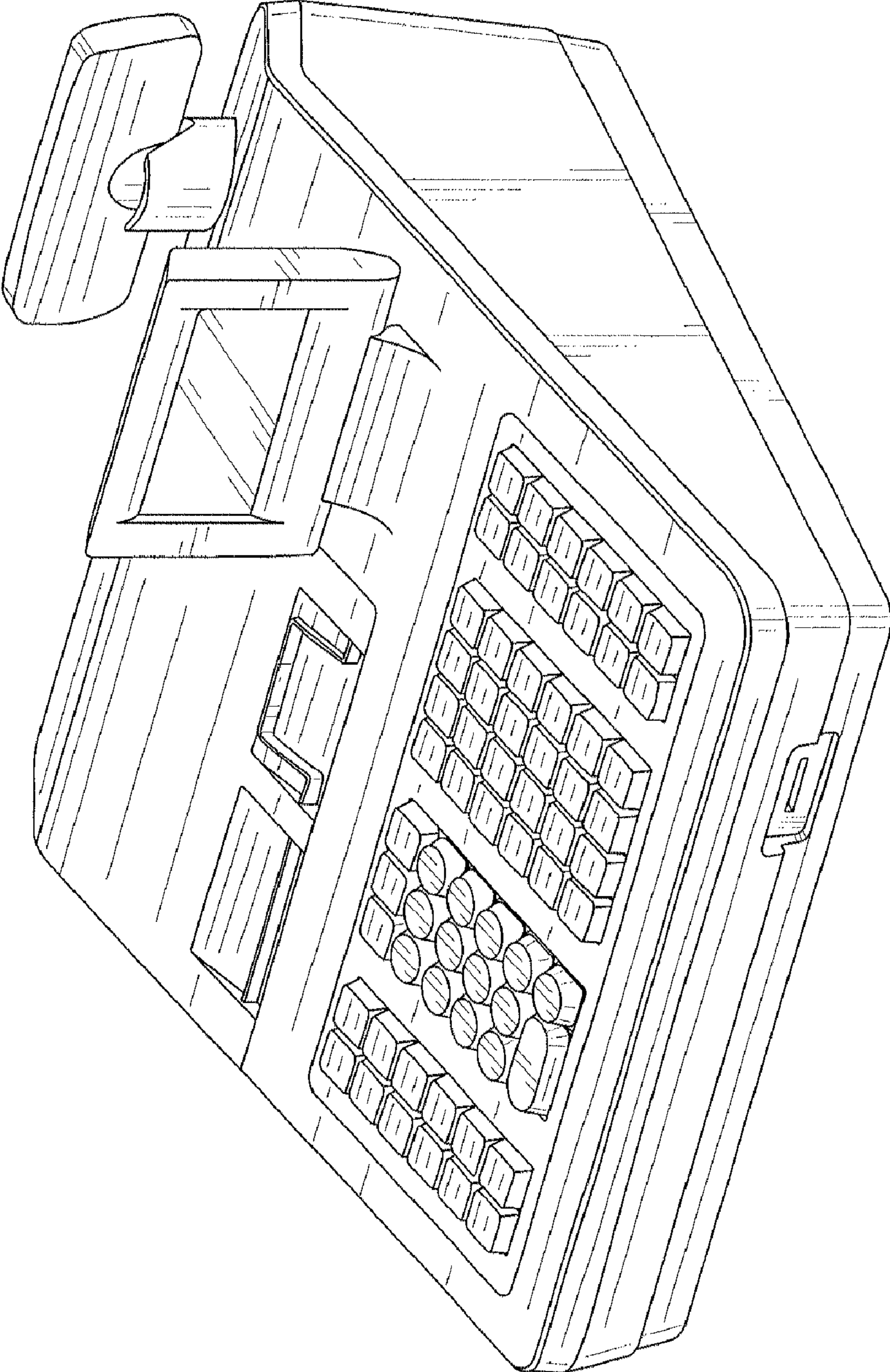

FIG. 1

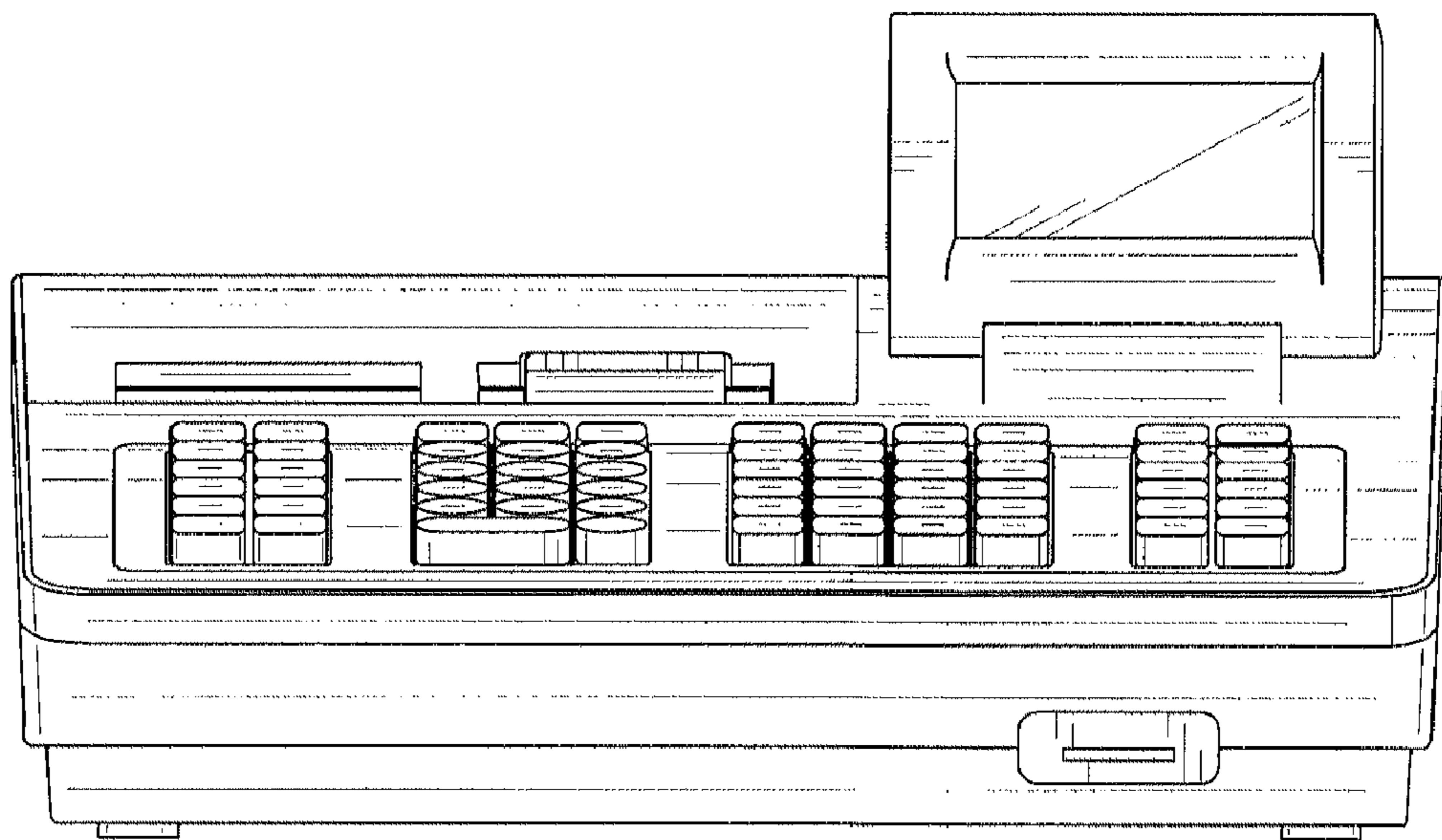
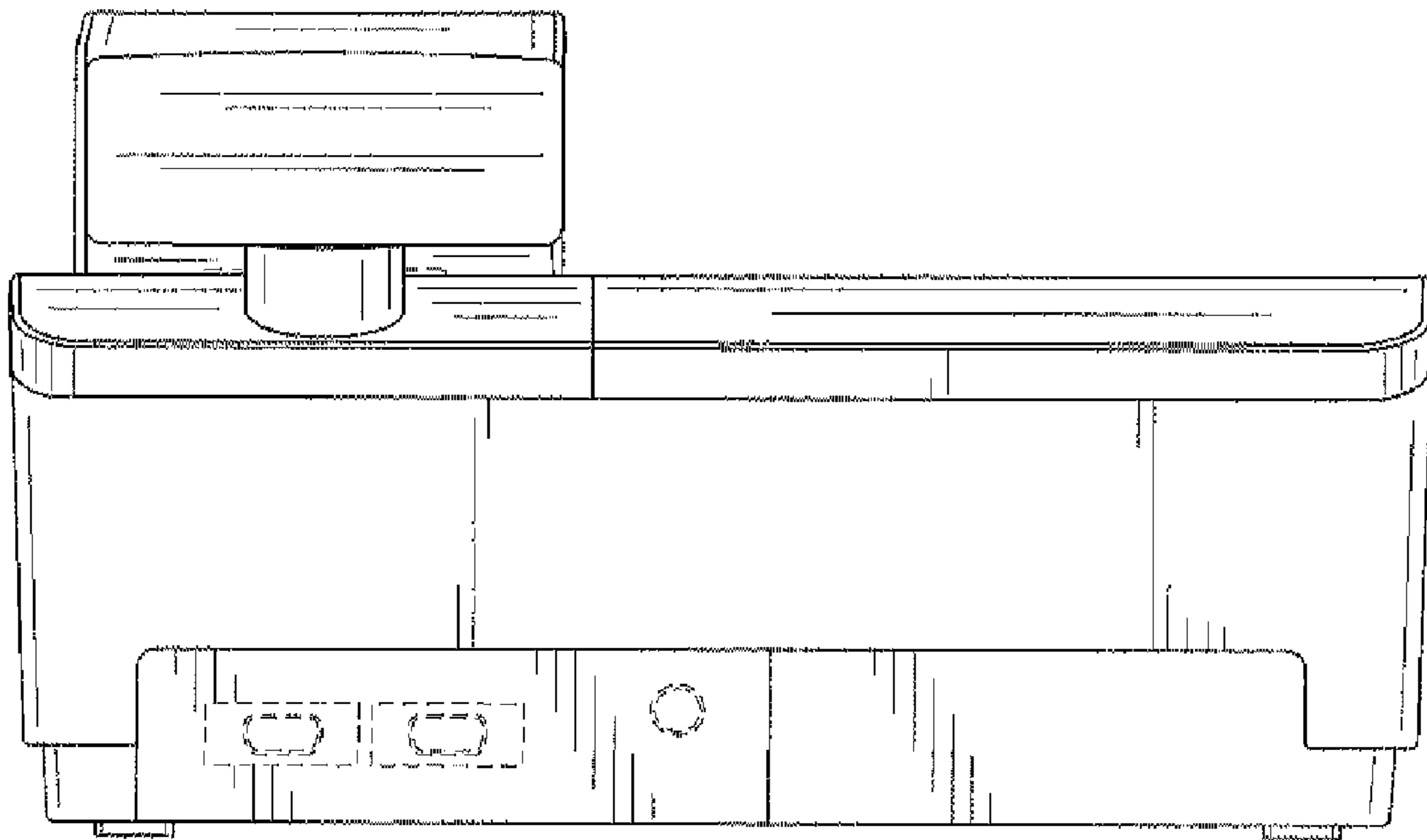

FIG. 2



**FIG. 3**

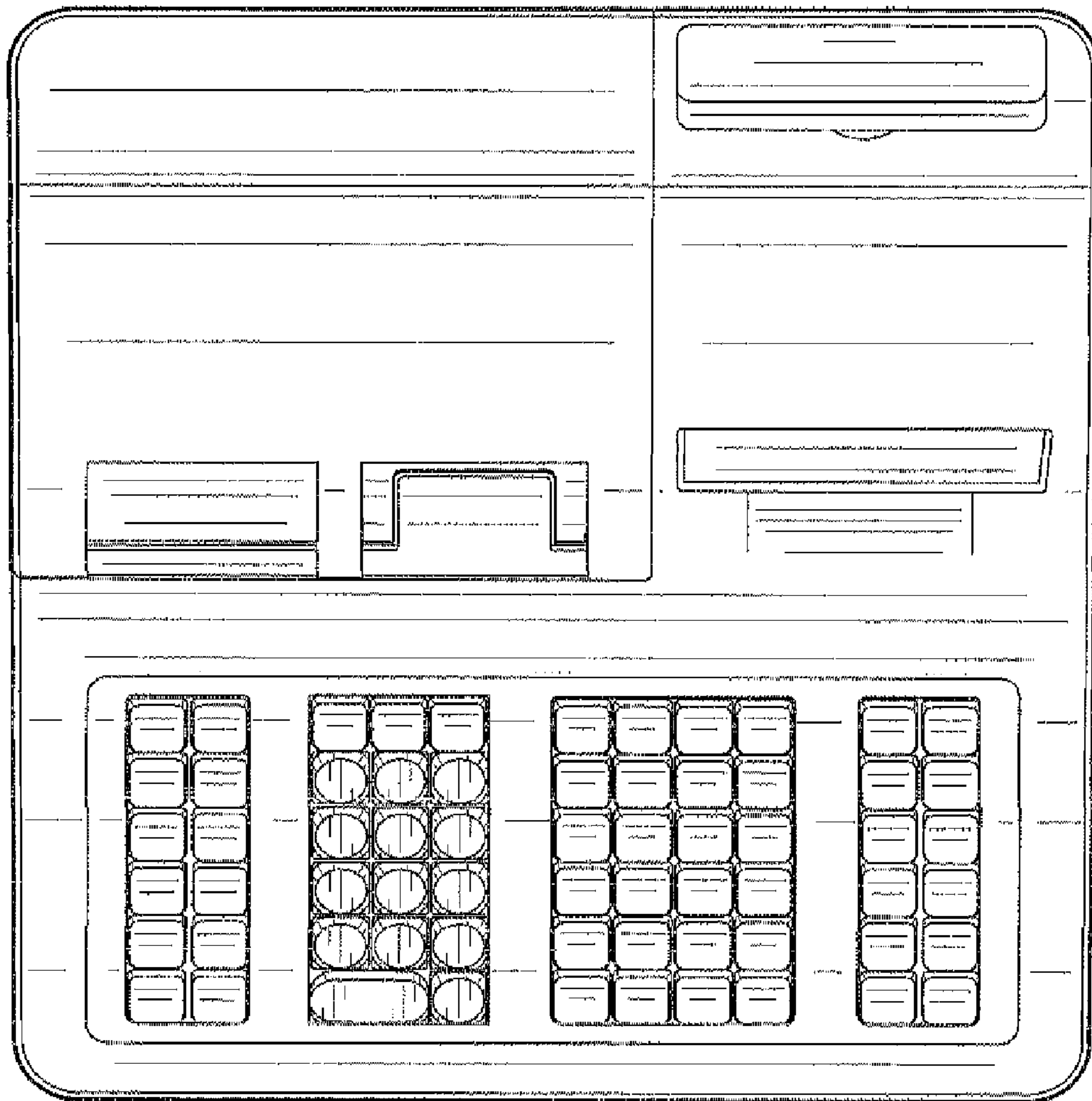

FIG. 4

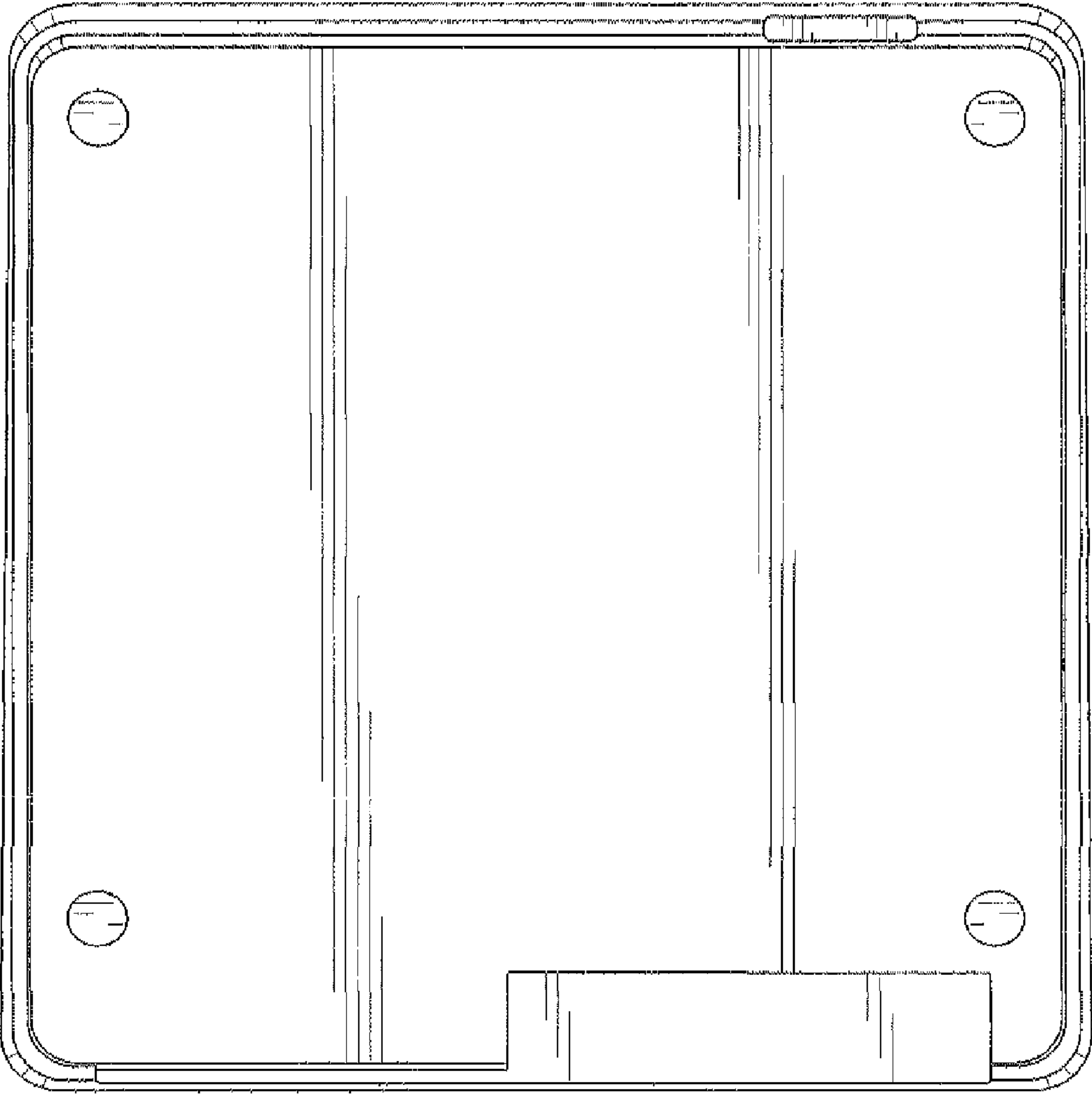

FIG. 5

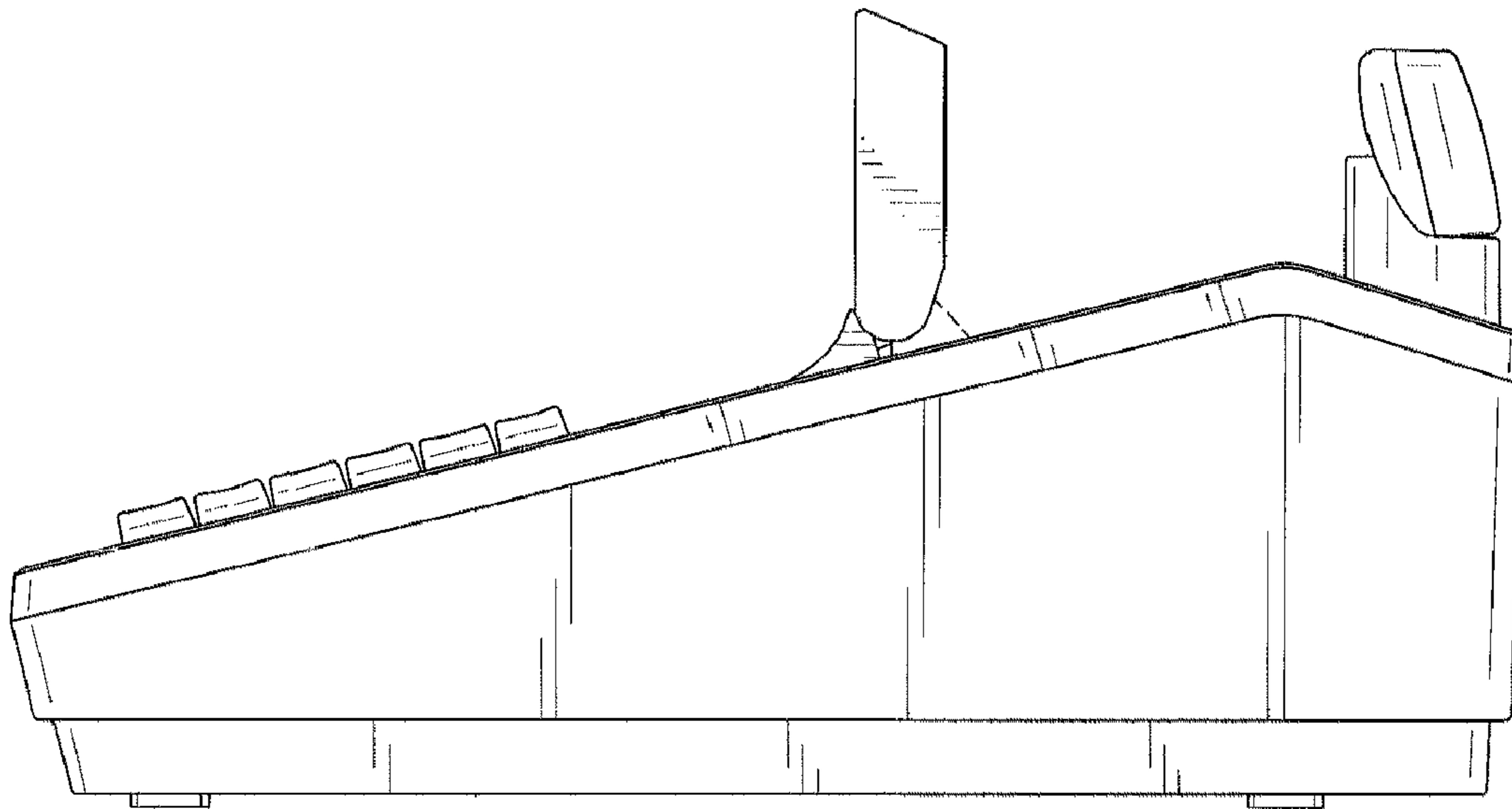

FIG. 6



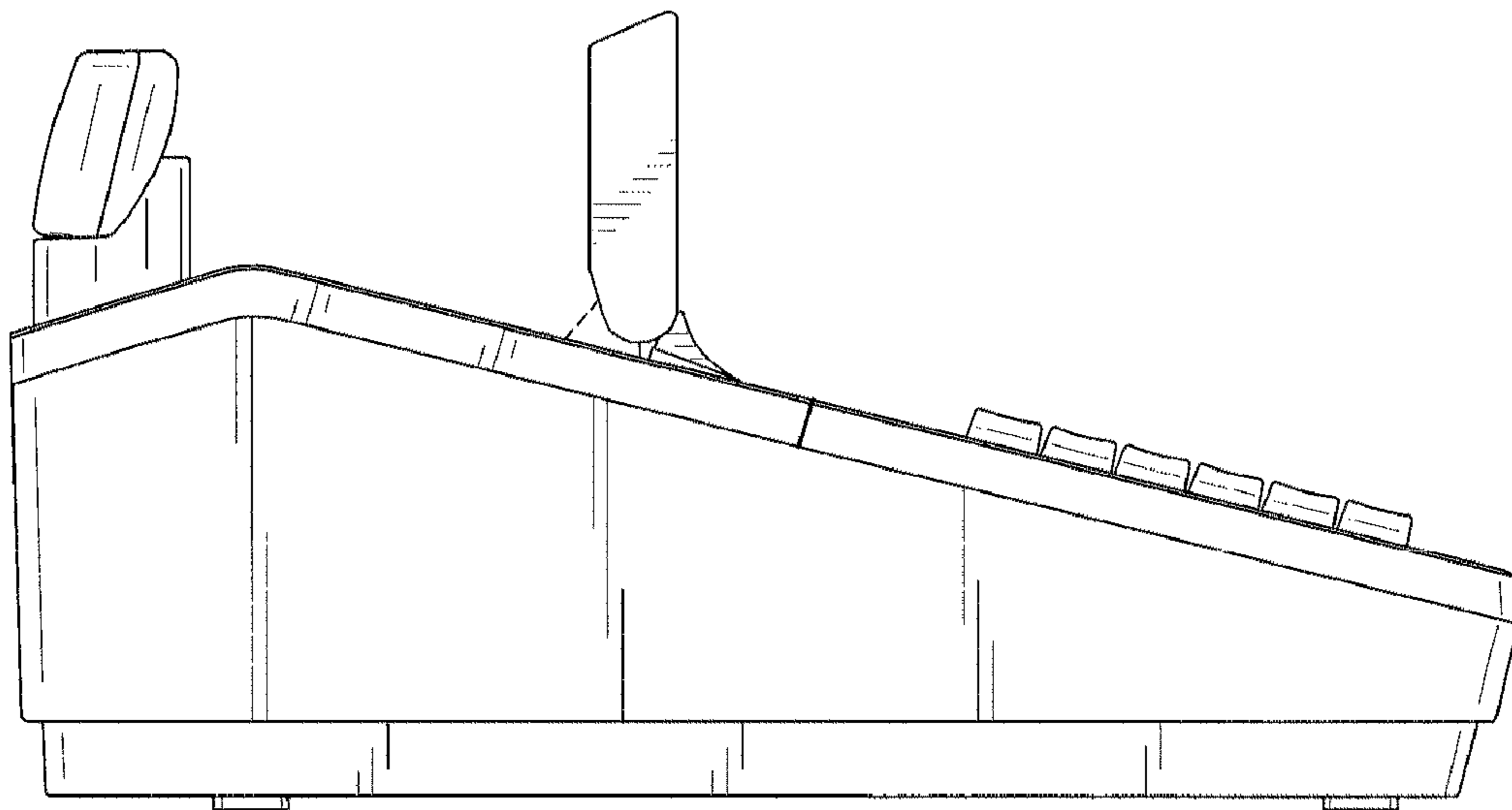

FIG. 7

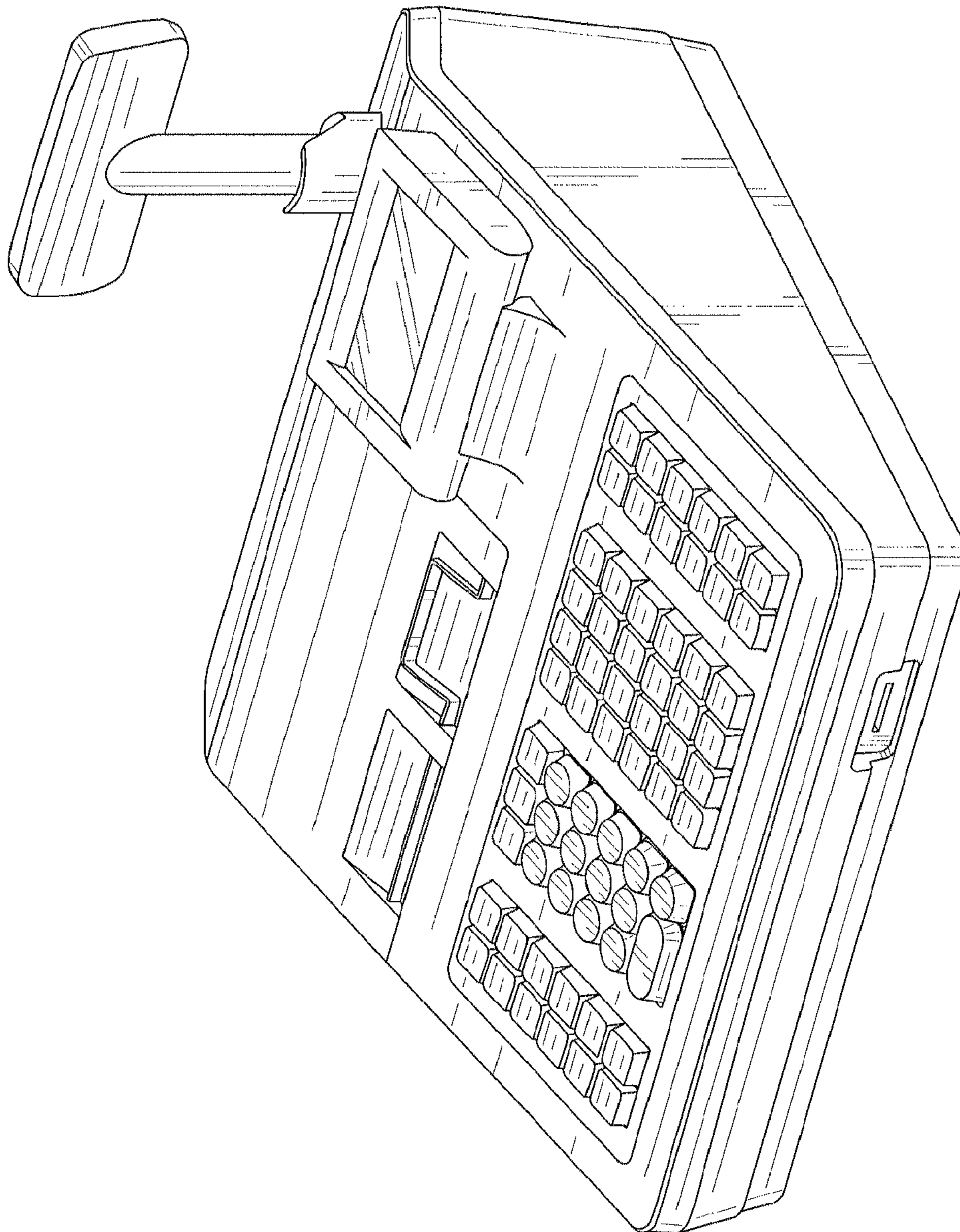

FIG. 8