



US00D658645S

(12) **United States Design Patent**
Sugita

(10) **Patent No.:** **US D658,645 S**
(45) **Date of Patent:** **** May 1, 2012**

(54) **IN-VEHICLE AUDIO RECEIVER**

(75) Inventor: **Muneki Sugita**, Tokyo (JP)

(73) Assignee: **Clarion Co., Ltd.**, Saitama (JP)

(**) Term: **14 Years**

(21) Appl. No.: **29/386,999**

(22) Filed: **Mar. 8, 2011**

(30) **Foreign Application Priority Data**

Sep. 8, 2010 (JP) 2010-21731

(51) **LOC (9) Cl.** **14-01**

(52) **U.S. Cl.** **D14/258**

(58) **Field of Classification Search** D14/496,
D14/498-511, 167-168, 188, 197-198, 157-158;
360/99.02, 99.07; 369/75.11, 75.21, 77.11,
369/77.21; 720/601, 612, 619, 649, 655;
455/344, 347-351

See application file for complete search history.

(56) **References Cited**

U.S. PATENT DOCUMENTS

D313,023 S * 12/1990 Kolenda et al. D14/258
5,862,468 A * 1/1999 Kim 455/321

D493,783 S * 8/2004 Pietras et al. D14/257
D532,006 S * 11/2006 Kim D14/258
D532,007 S * 11/2006 Park D14/258

* cited by examiner

Primary Examiner — Nanda Bondade

(74) *Attorney, Agent, or Firm* — Scully, Scott, Murphy & Presser, P.C.

(57) **CLAIM**

The ornamental design for an in-vehicle audio receiver, as shown and described.

DESCRIPTION

FIG. 1 is a front and right perspective view of an in-vehicle audio receiver showing my new design;
FIG. 2 is a front and left perspective view thereof;
FIG. 3 is a front view thereof;
FIG. 4 is a rear view thereof;
FIG. 5 is a right side view thereof;
FIG. 6 is a left side view thereof;
FIG. 7 is a top view thereof; and,
FIG. 8 is a bottom view thereof.

The portions indicated in broken lines are for illustrative purposes only and form no part of the claimed design.

1 Claim, 3 Drawing Sheets

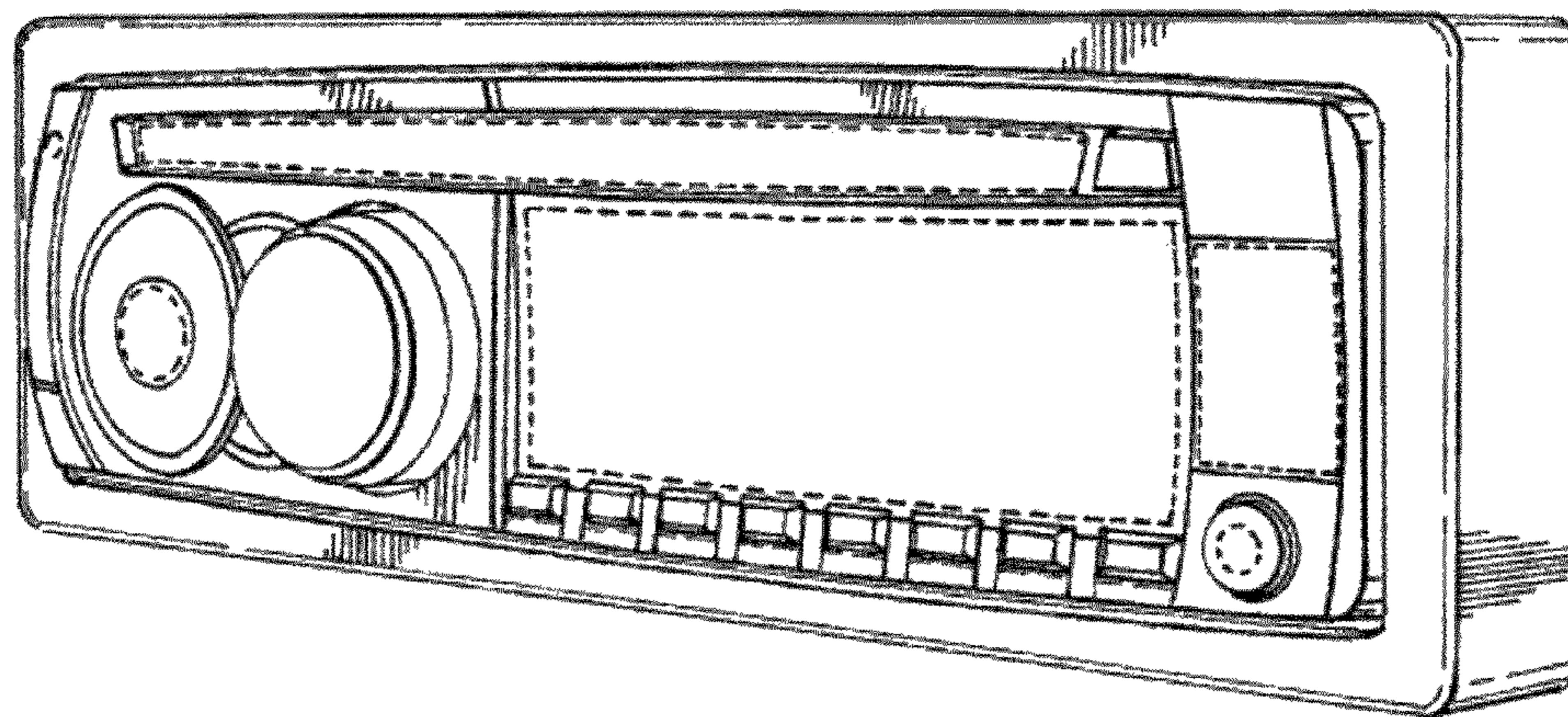

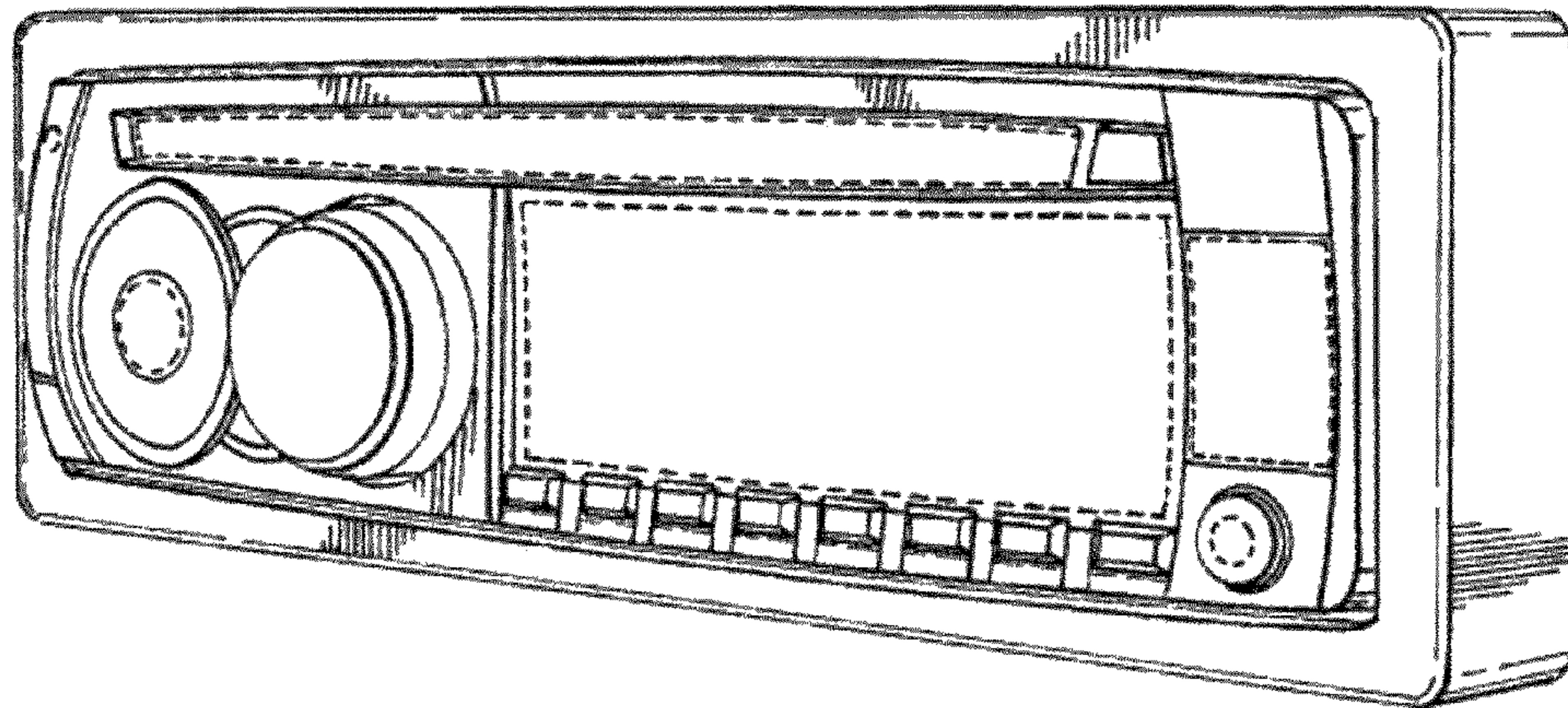

Fig. 1

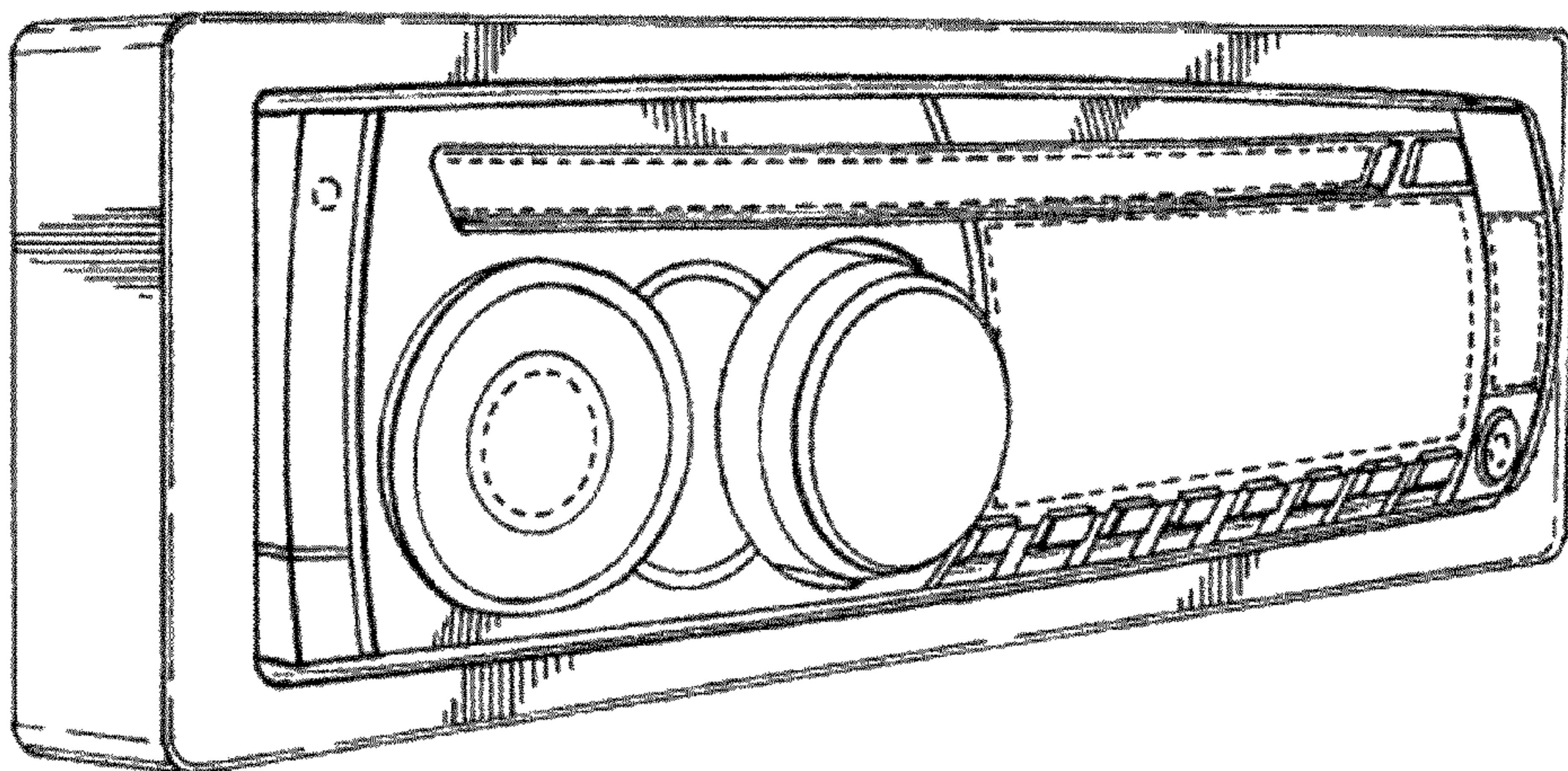

Fig. 2

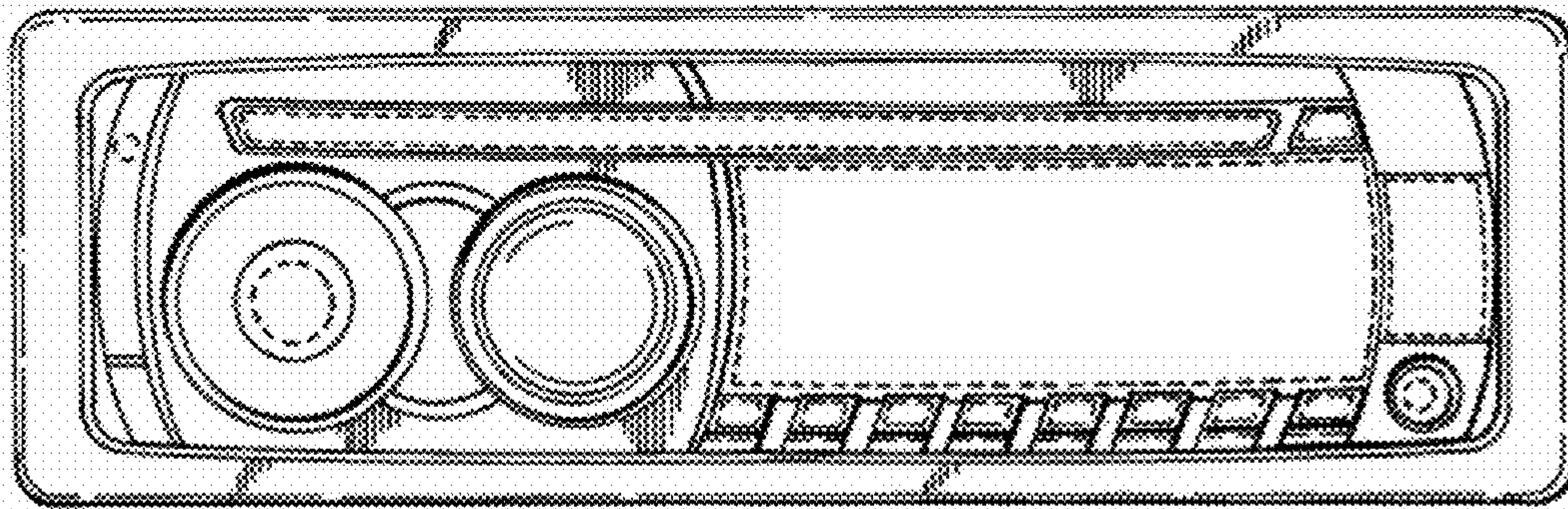

Fig. 3

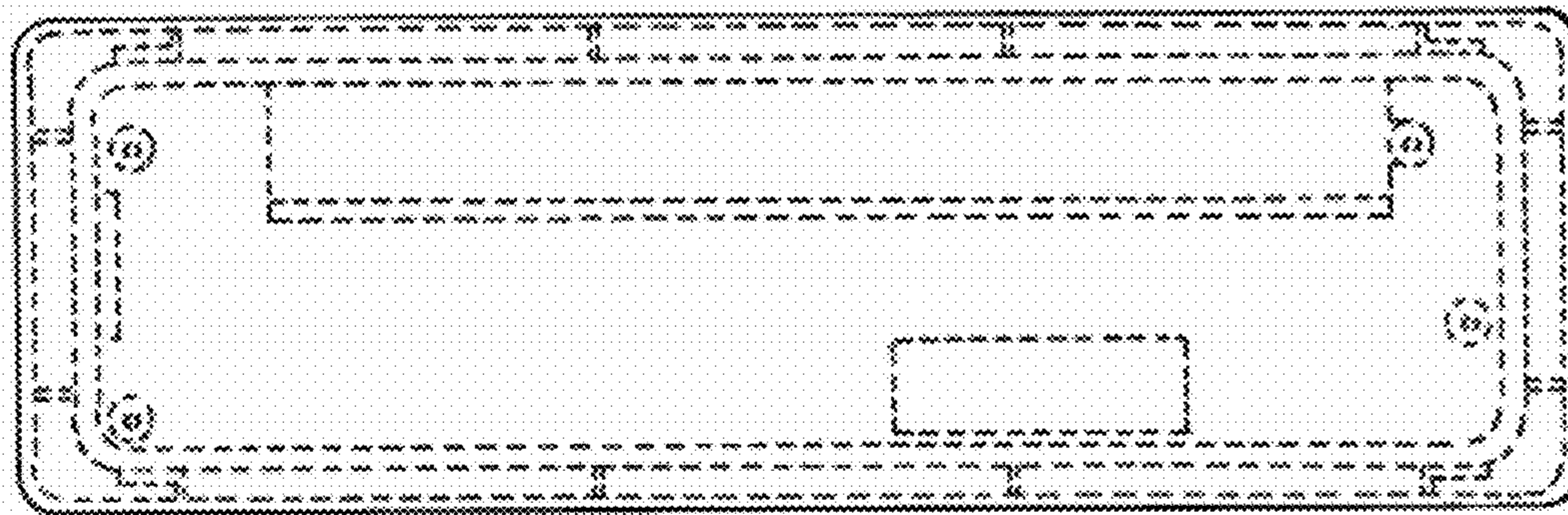

Fig. 4

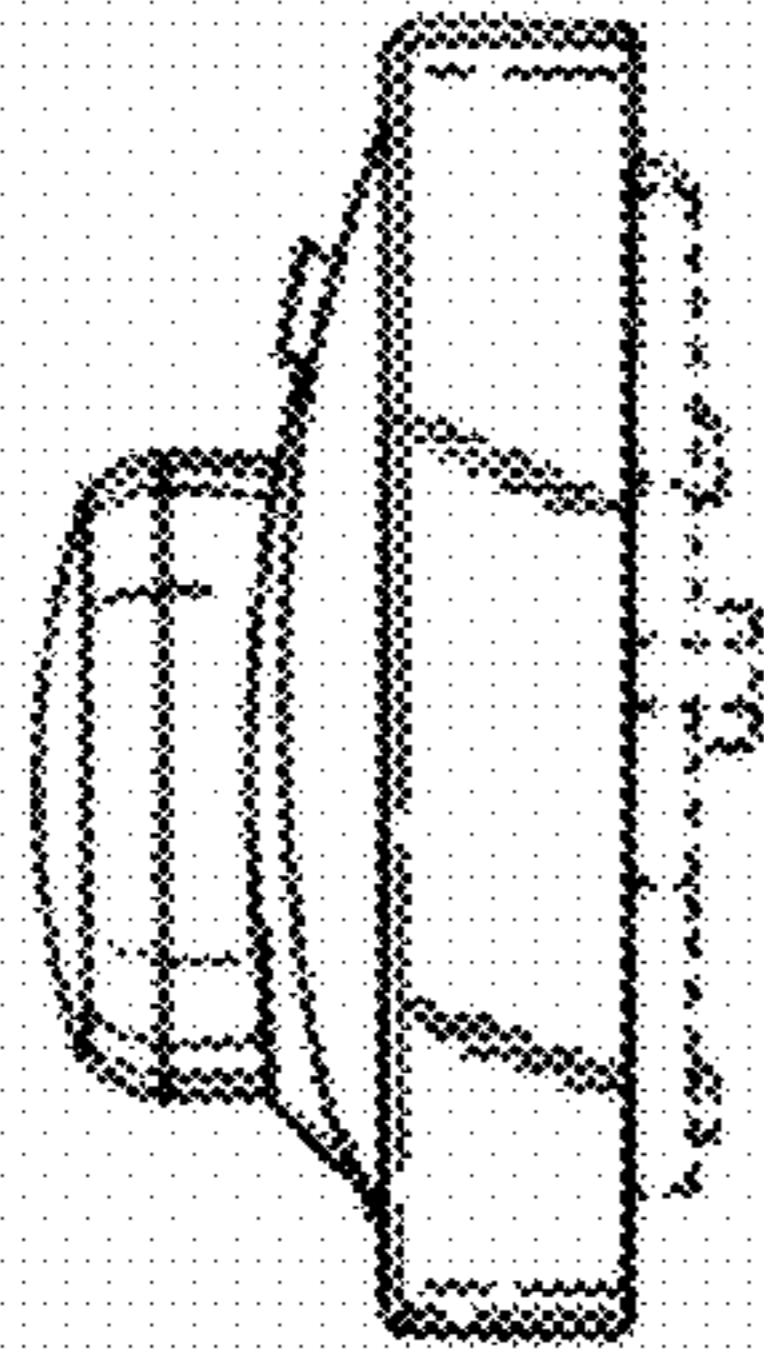

Fig. 5

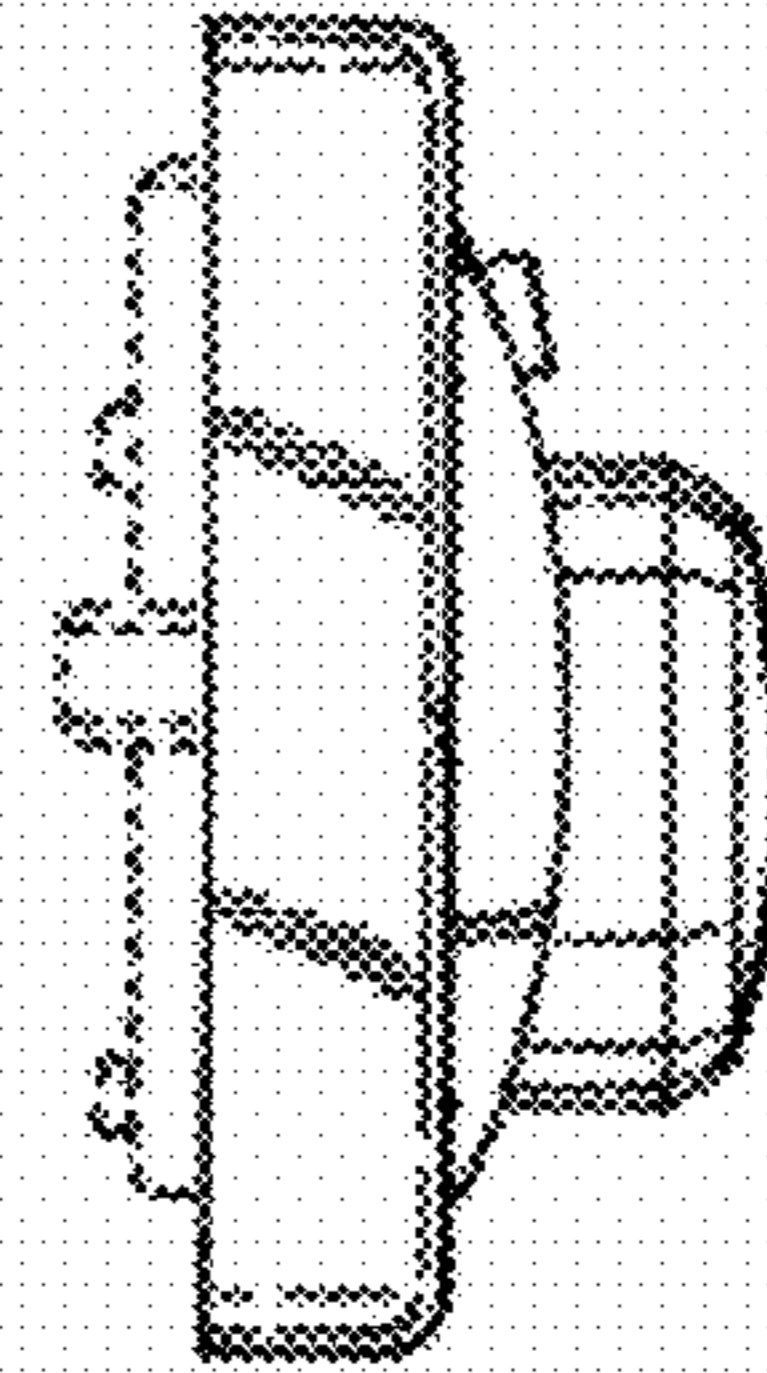

Fig. 6

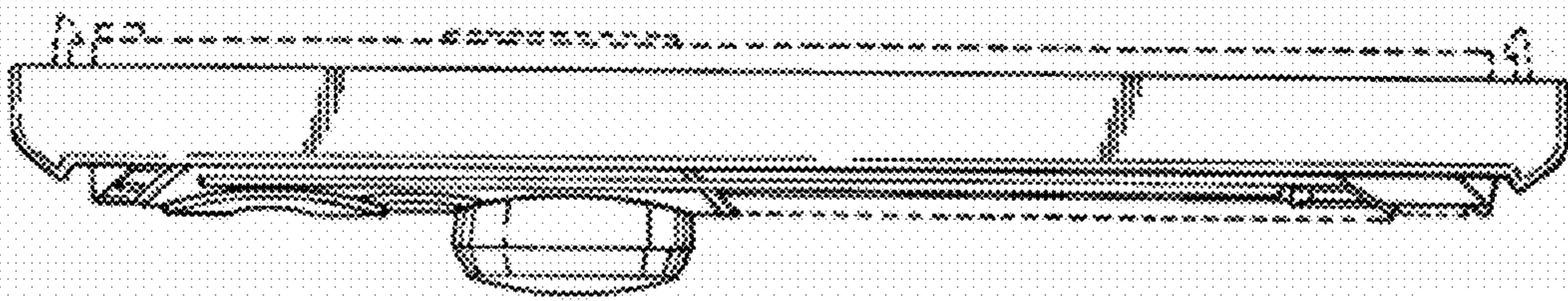

Fig. 7

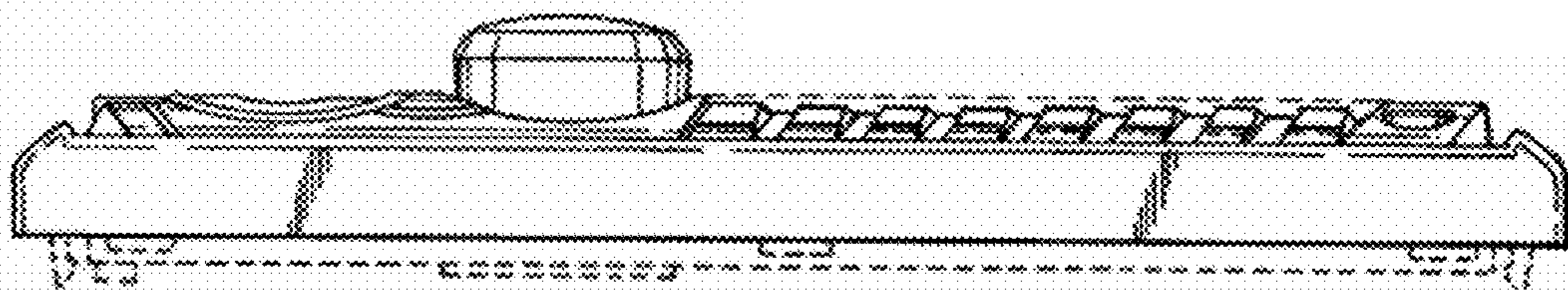

Fig. 8