



US00D658629S

(12) **United States Design Patent**
Nomura

(10) **Patent No.:** **US D658,629 S**

(45) **Date of Patent:** **** May 1, 2012**

(54) **HEADPHONE**

(75) **Inventor:** **Yuto Nomura, Tokyo (JP)**

(73) **Assignee:** **JVC Kenwood Corporation, Yokohama (JP)**

(**) **Term:** **14 Years**

(21) **Appl. No.:** **29/386,144**

(22) **Filed:** **Feb. 25, 2011**

(30) **Foreign Application Priority Data**

Nov. 12, 2010 (JP) 2010-027264

(51) **LOC (9) Cl.** **14-01**

(52) **U.S. Cl.** **D14/205**

(58) **Field of Classification Search** D14/205,
D14/206, 223; 181/129, 130; D29/112;
379/430, 431; 381/380, 381; 2/209

See application file for complete search history.

(56) **References Cited**

U.S. PATENT DOCUMENTS

3,104,398 A * 9/1963 Palmaer 2/209
3,454,964 A * 7/1969 Brinkhoff 2/209
D222,361 S * 10/1971 Hart D14/205
5,384,857 A * 1/1995 Nordin et al. 381/378

D403,128 S * 12/1998 Scanlon et al. D29/122
D549,688 S * 8/2007 Suzuki D14/205
D597,070 S * 7/2009 Zheng D14/205
D634,732 S * 3/2011 Kondo et al. D14/205
D638,397 S * 5/2011 McManigal D14/205
D641,003 S * 7/2011 Alden D14/205
D641,725 S * 7/2011 Chong et al. D14/205

* cited by examiner

Primary Examiner — Paula Greene

(74) *Attorney, Agent, or Firm* — The Nath Law Group;
Jerald L. Meyer; Gregory G. Bennett

(57) **CLAIM**

The ornamental design for a headphone, as shown and described.

DESCRIPTION

FIG. 1 is a perspective view of a headphone;
FIG. 2 is a front view thereof;
FIG. 3 is a rear view thereof;
FIG. 4 is a right side view thereof;
FIG. 5 is a left side view thereof;
FIG. 6 is a top plan view thereof; and,
FIG. 7 is a bottom plan view thereof.

The broken lines showing on the drawing disclosure are for illustrative purposes only and form no part of the claimed design.

1 Claim, 6 Drawing Sheets

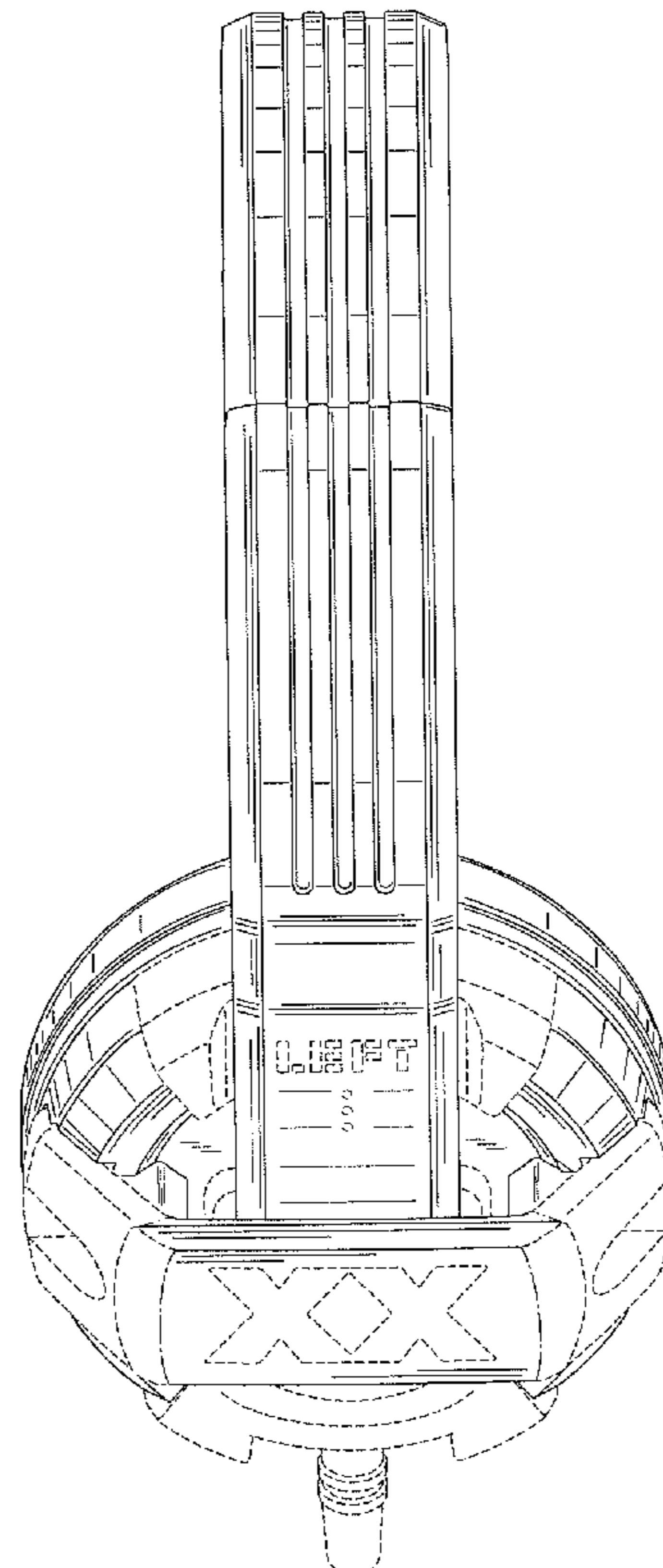
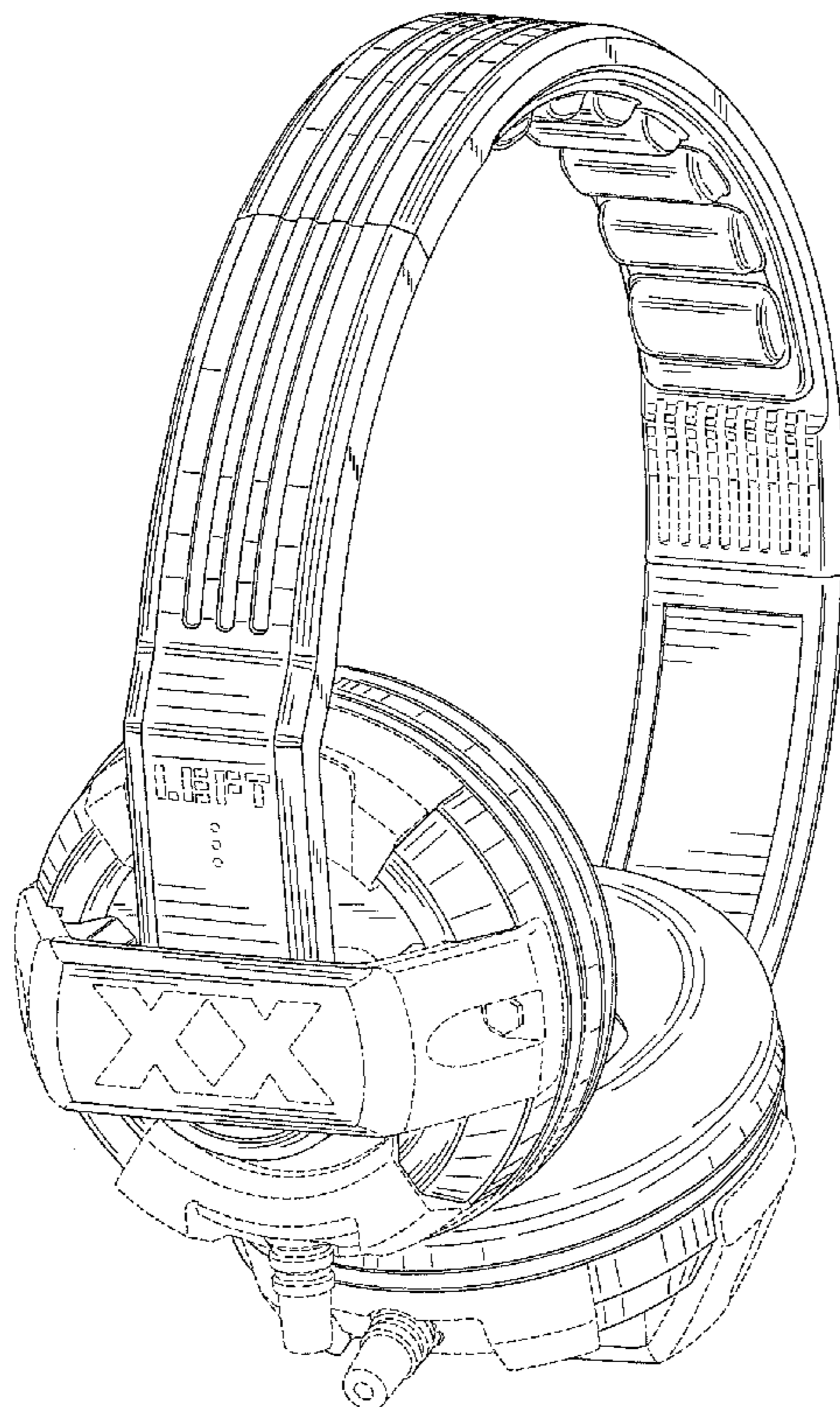

Fig.1

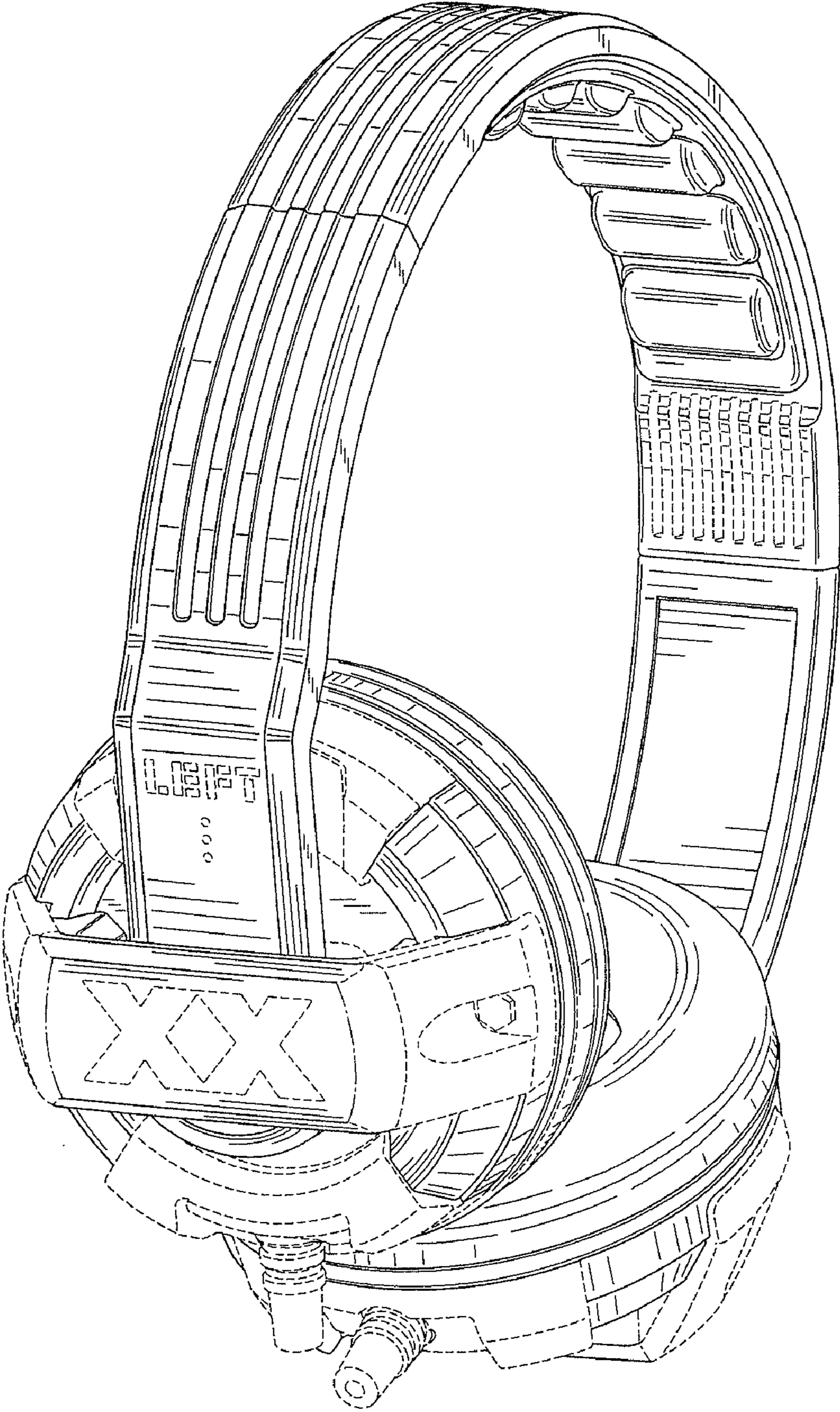

Fig.2



Fig.3

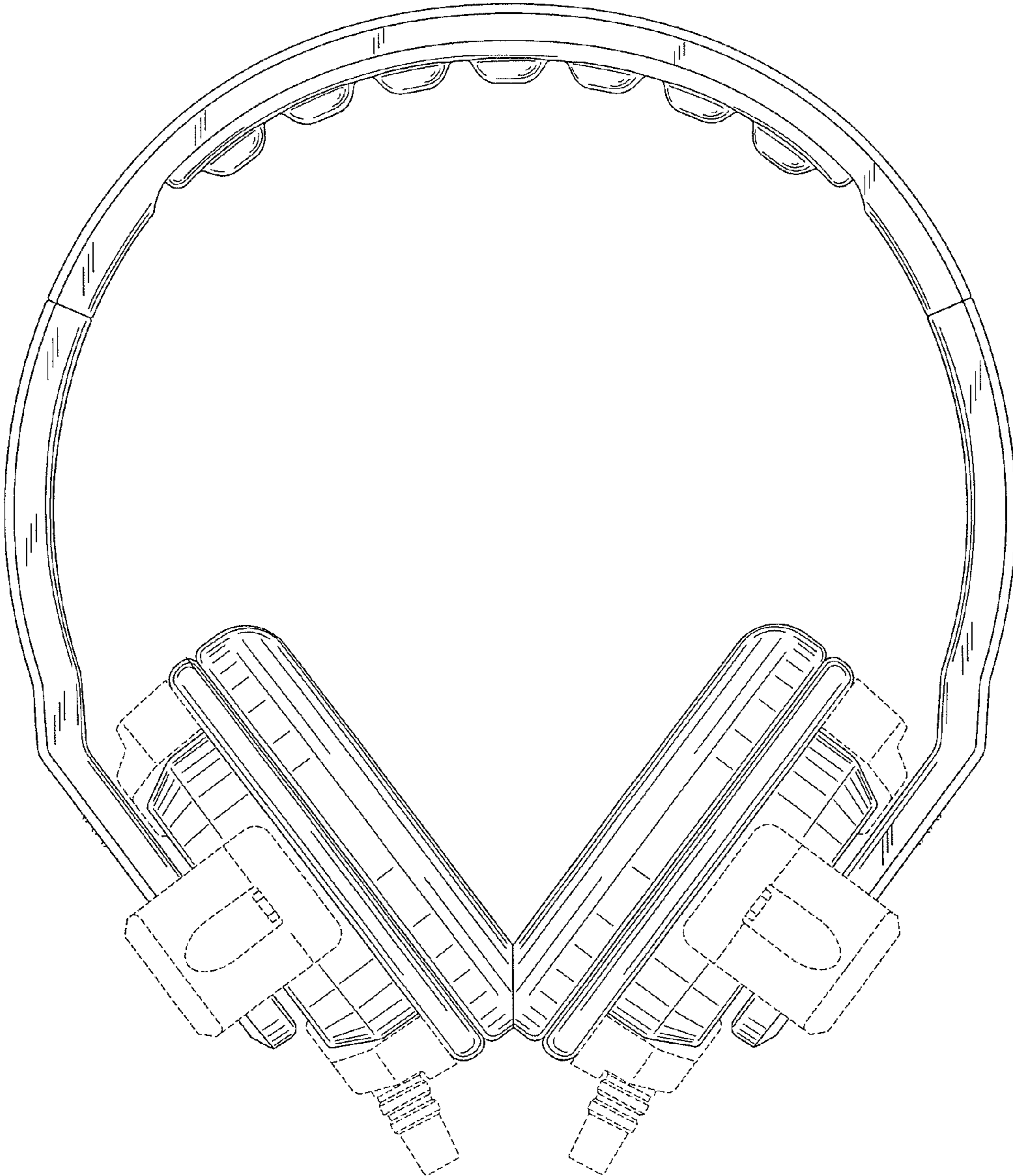

Fig.4

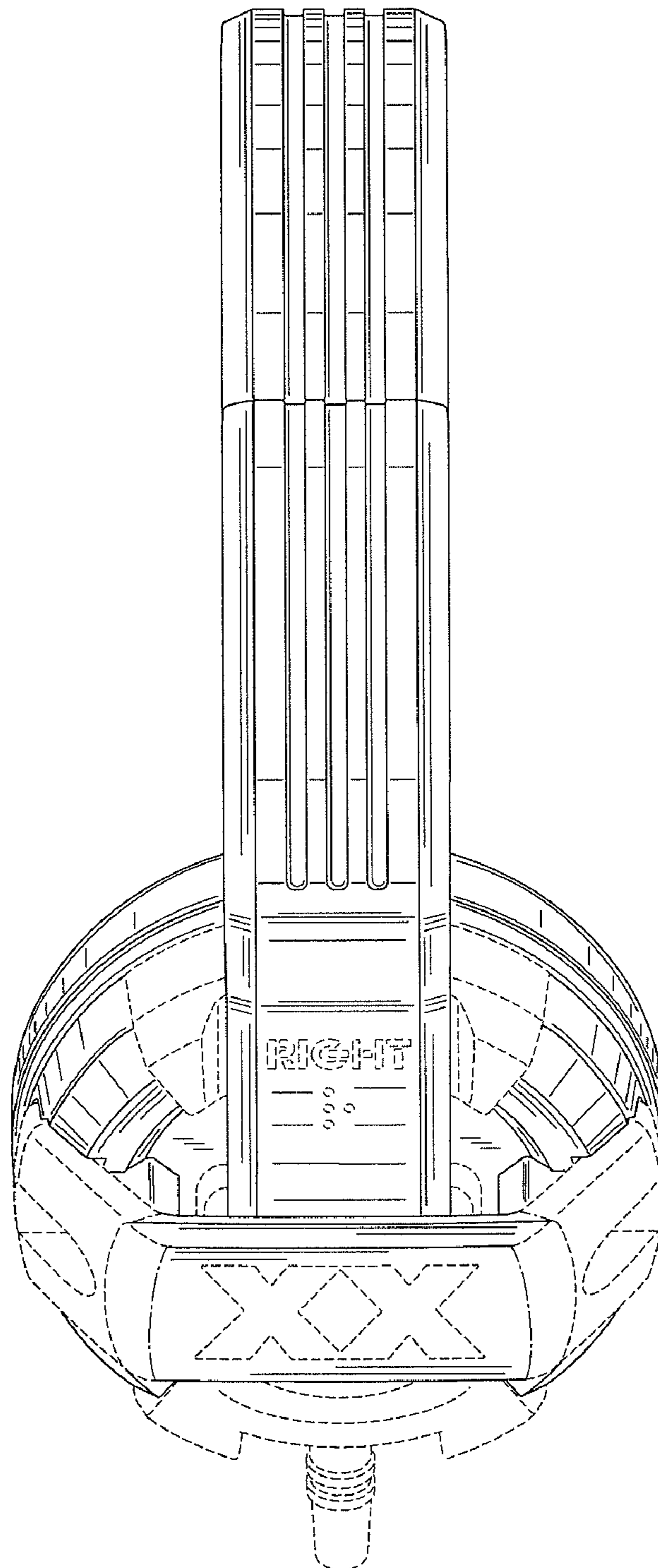

Fig.5

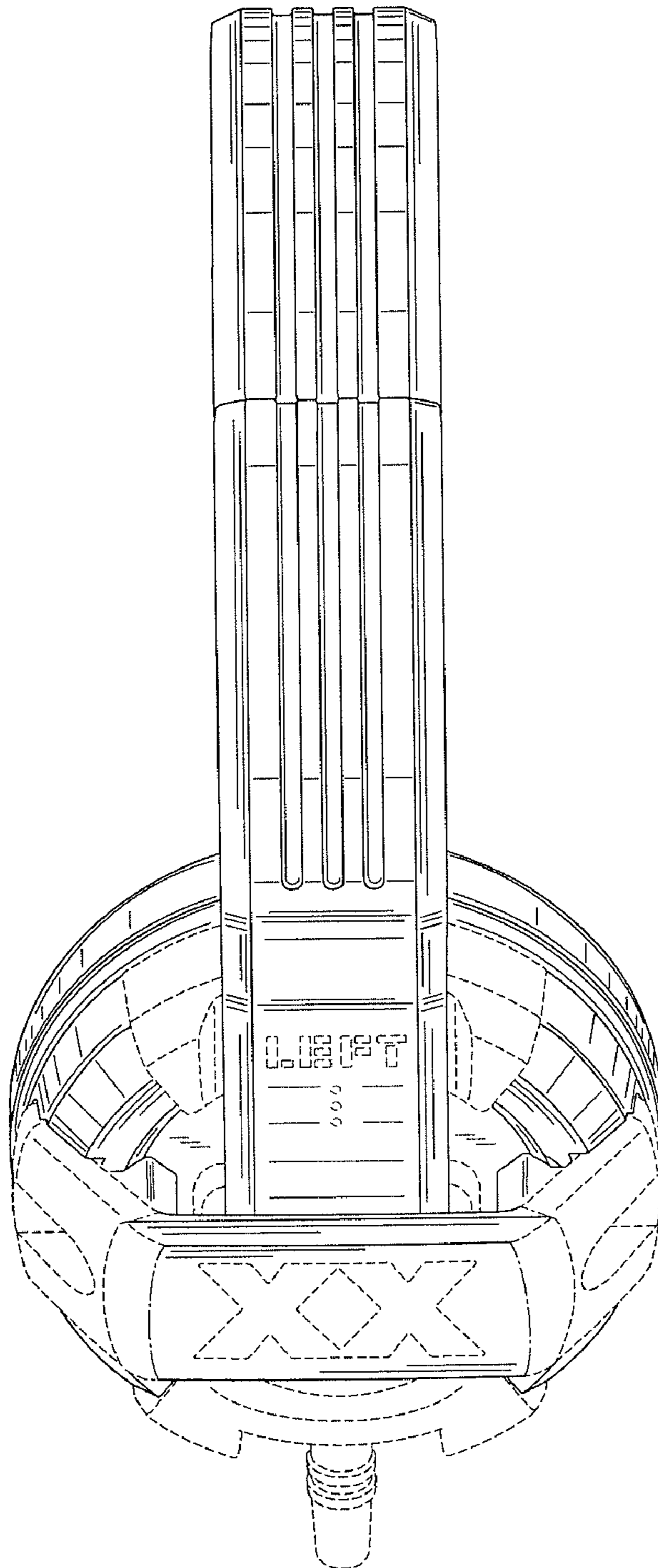

Fig.6

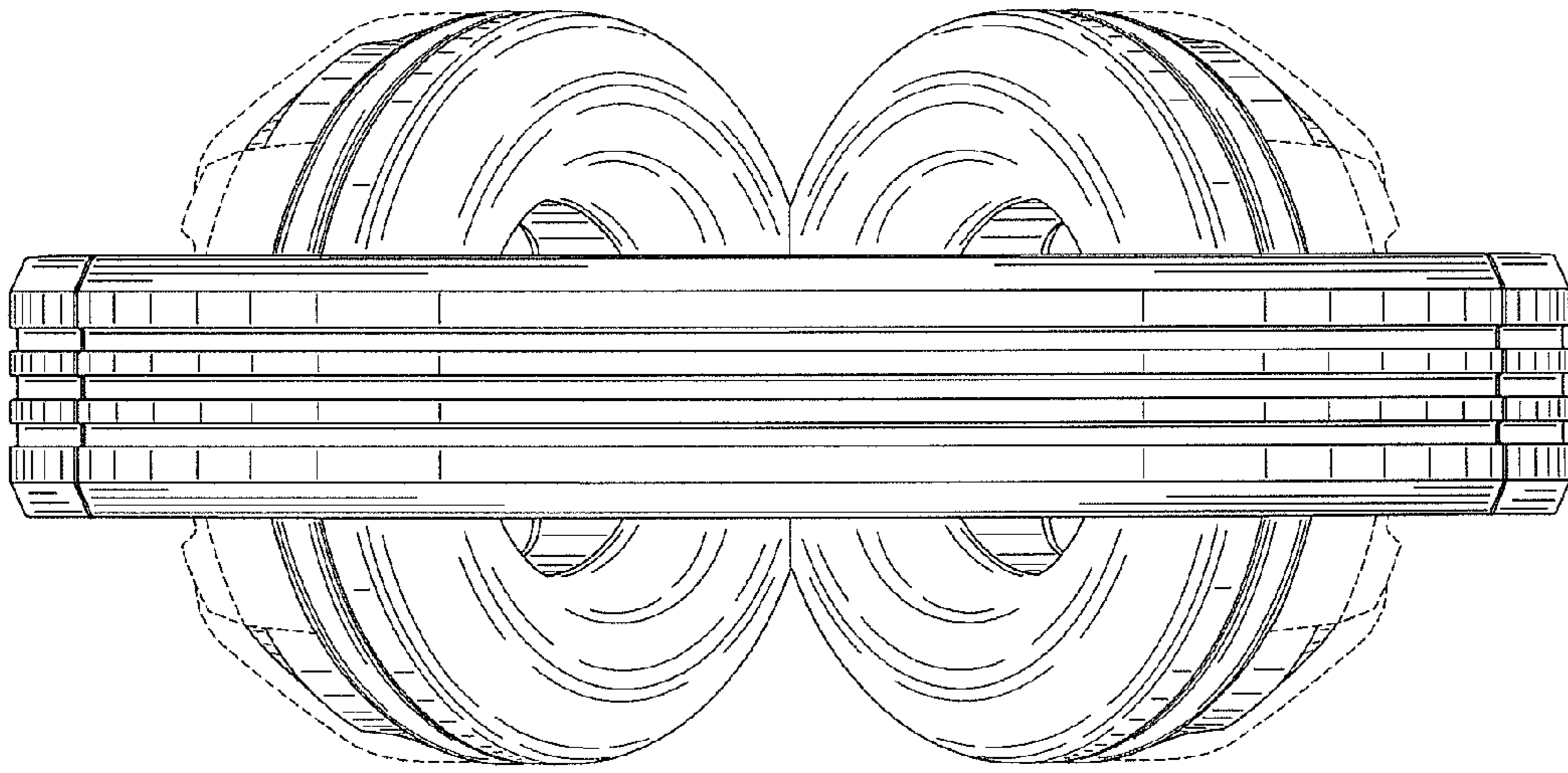

Fig.7

