



US00D658340S

(12) **United States Design Patent**
Jeon et al.

(10) **Patent No.:** **US D658,340 S**
(45) **Date of Patent:** **** Apr. 24, 2012**

(54) **WASHING MACHINE**

(75) Inventors: **Hoil Jeon**, Gyeonggi-do (KR); **Nerry Son**, Seoul (KR); **Yeji Um**, Seoul (KR); **Junghwan Lee**, Seoul (KR)

(73) Assignee: **LG Electronics Inc.**, Seoul (KR)

(**) Term: **14 Years**

(21) Appl. No.: **29/387,442**

(22) Filed: **Mar. 14, 2011**

(30) **Foreign Application Priority Data**

Sep. 16, 2010 (KR) 30-2010-0041164

(51) **LOC (9) Cl.** **15-05**

(52) **U.S. Cl.** **D32/6**

(58) **Field of Classification Search** D32/1,
D32/5-6, 8, 10, 25; 34/58, 108, 523, 595-597,
34/603; 68/3 R, 4, 5 R, 12.01, 12.08, 212
See application file for complete search history.

(56) **References Cited**

U.S. PATENT DOCUMENTS

D183,638 S *	9/1958	Sandburg	D32/6
D557,466 S *	12/2007	Suh	D32/6
D571,511 S *	6/2008	Cadamuro	D32/8
D582,107 S *	12/2008	Ha et al.	D32/6
D584,865 S *	1/2009	Kim et al.	D32/6
D585,165 S *	1/2009	Kim et al.	D32/6
D613,466 S *	4/2010	Kim	D32/6

D613,467 S *	4/2010	Park et al.	D32/6
D614,366 S *	4/2010	Shor	D32/6
D627,114 S *	11/2010	Jeon et al.	D32/6
D627,529 S *	11/2010	Jeon et al.	D32/6
D642,753 S *	8/2011	Ha	D32/6

* cited by examiner

Primary Examiner — T. Chase Nelson

Assistant Examiner — Kathleen M Sims

(74) *Attorney, Agent, or Firm* — Birch, Stewart, Kolasch & Birch, LLP

(57) **CLAIM**

The ornamental design for a washing machine as shown and described.

DESCRIPTION

FIG. 1 is a perspective view of a washing machine showing our new design;

FIG. 2 is a front view thereof;

FIG. 3 is a rear view thereof;

FIG. 4 is a left side view thereof;

FIG. 5 is a right side view thereof;

FIG. 6 is a top plan view thereof;

FIG. 7 is a bottom plan view thereof;

FIG. 8 is a perspective view thereof showing the state that during operation, the front part of this washing machine has been become transparent; and,

FIG. 9 is a perspective view showing the state that the detergent box at the upper part of the washing machine has been opened.

The broken line showing of details in FIGS. 4, 6, 7, 8 and 9 is included for the purpose of showing portions of the washing machine that form no part of the claimed design.

1 Claim, 9 Drawing Sheets

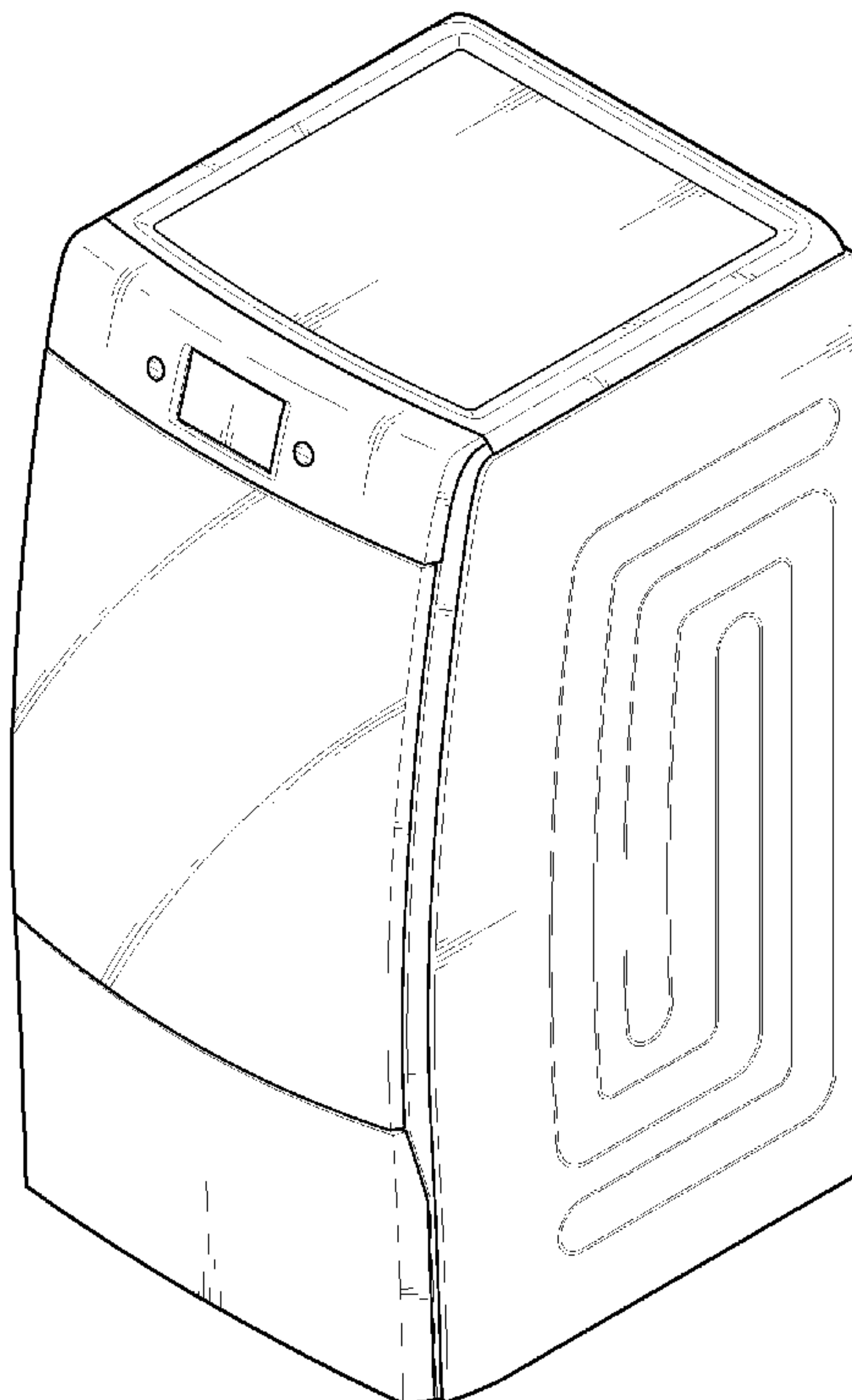

FIG. 1

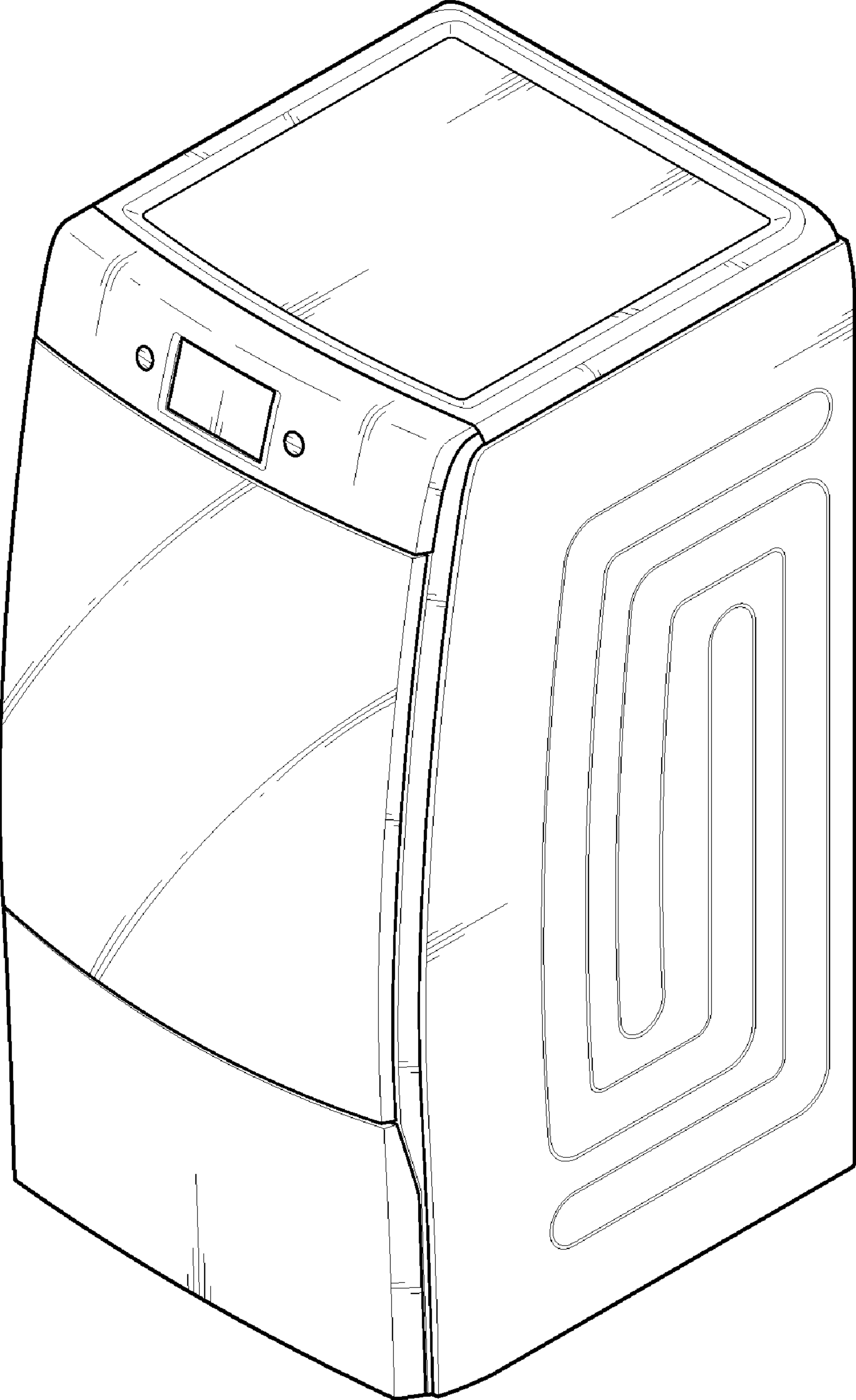

FIG. 2

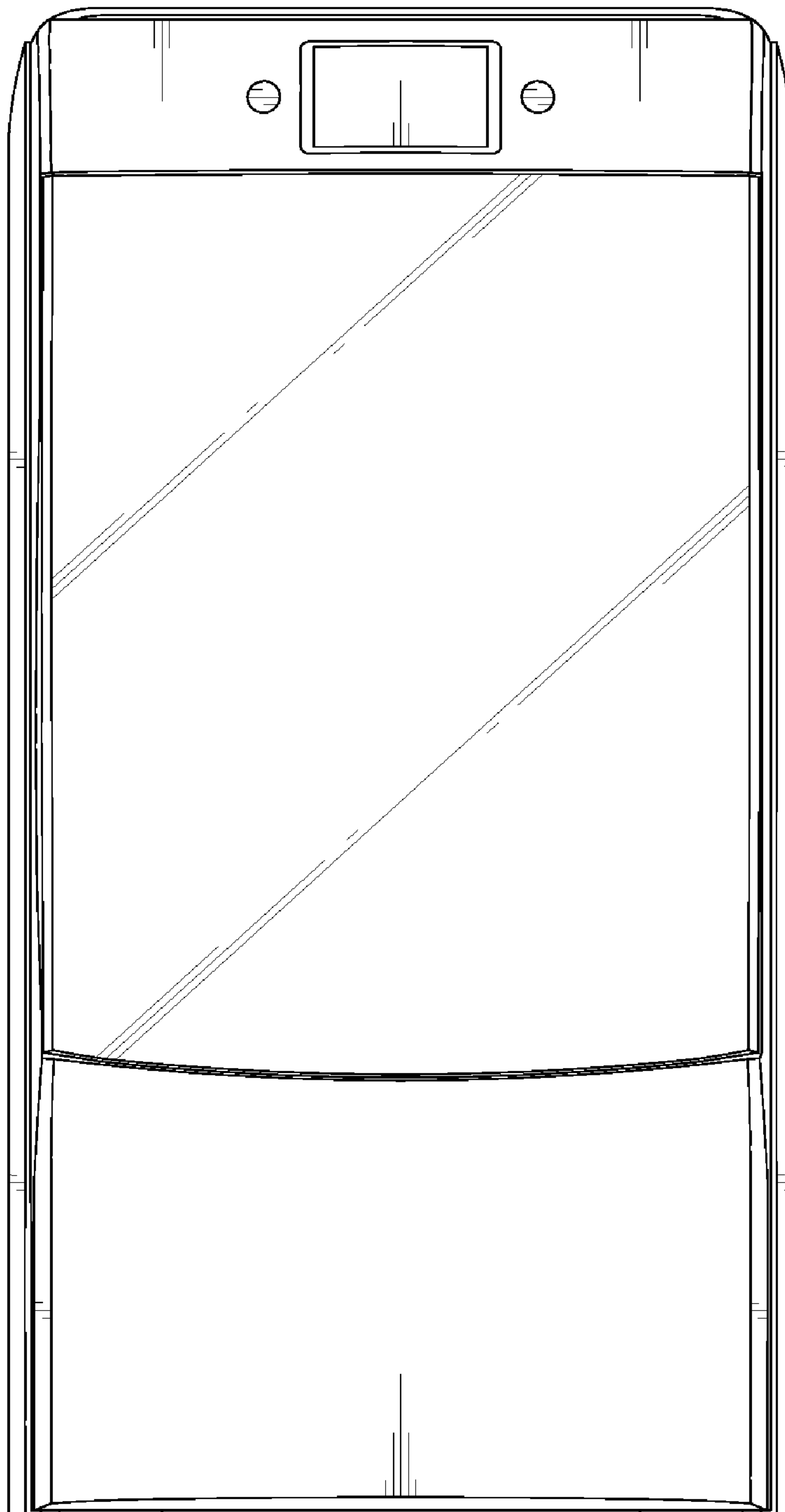

FIG. 3

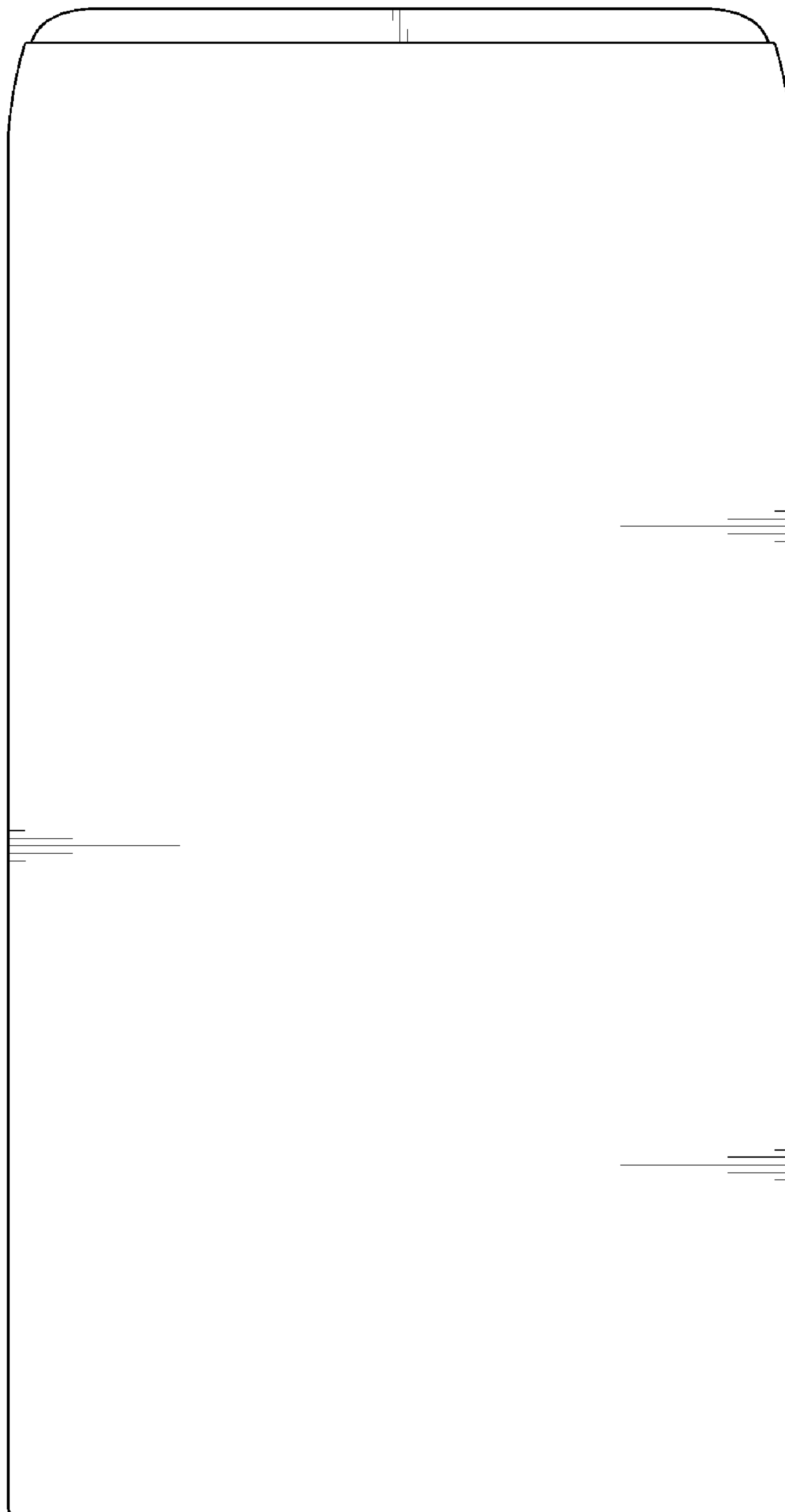

FIG. 4

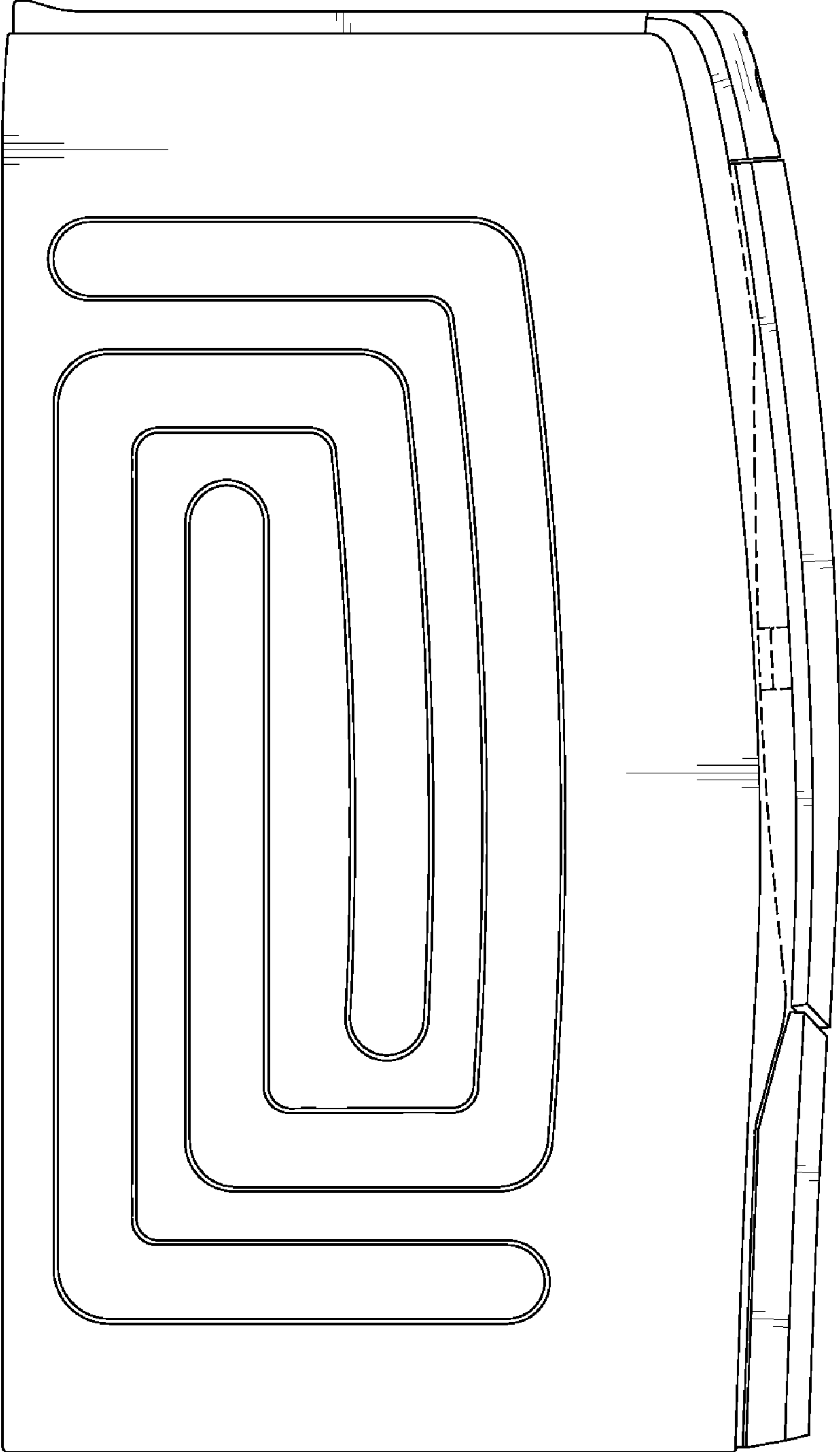

FIG. 5

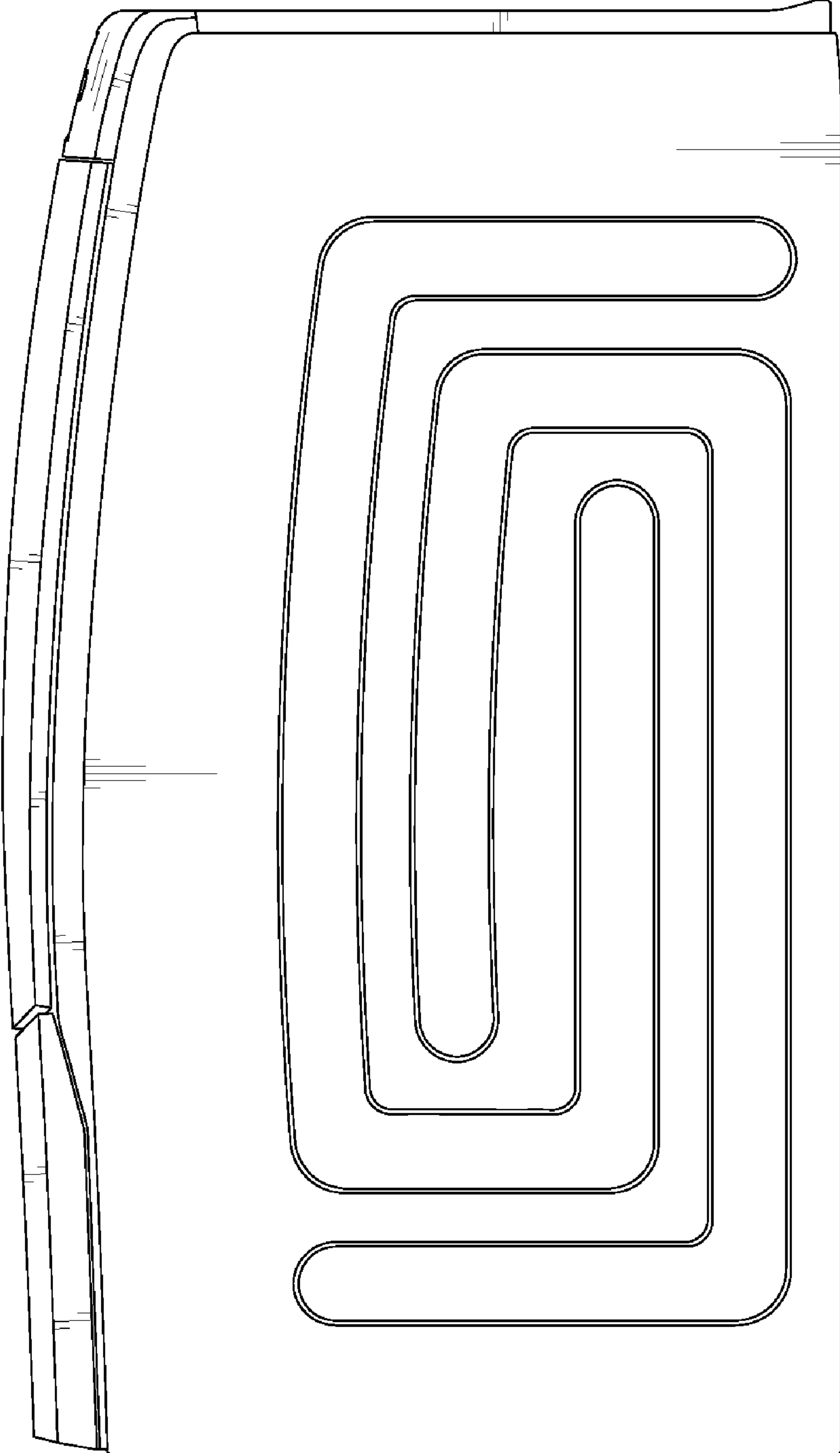

FIG. 6

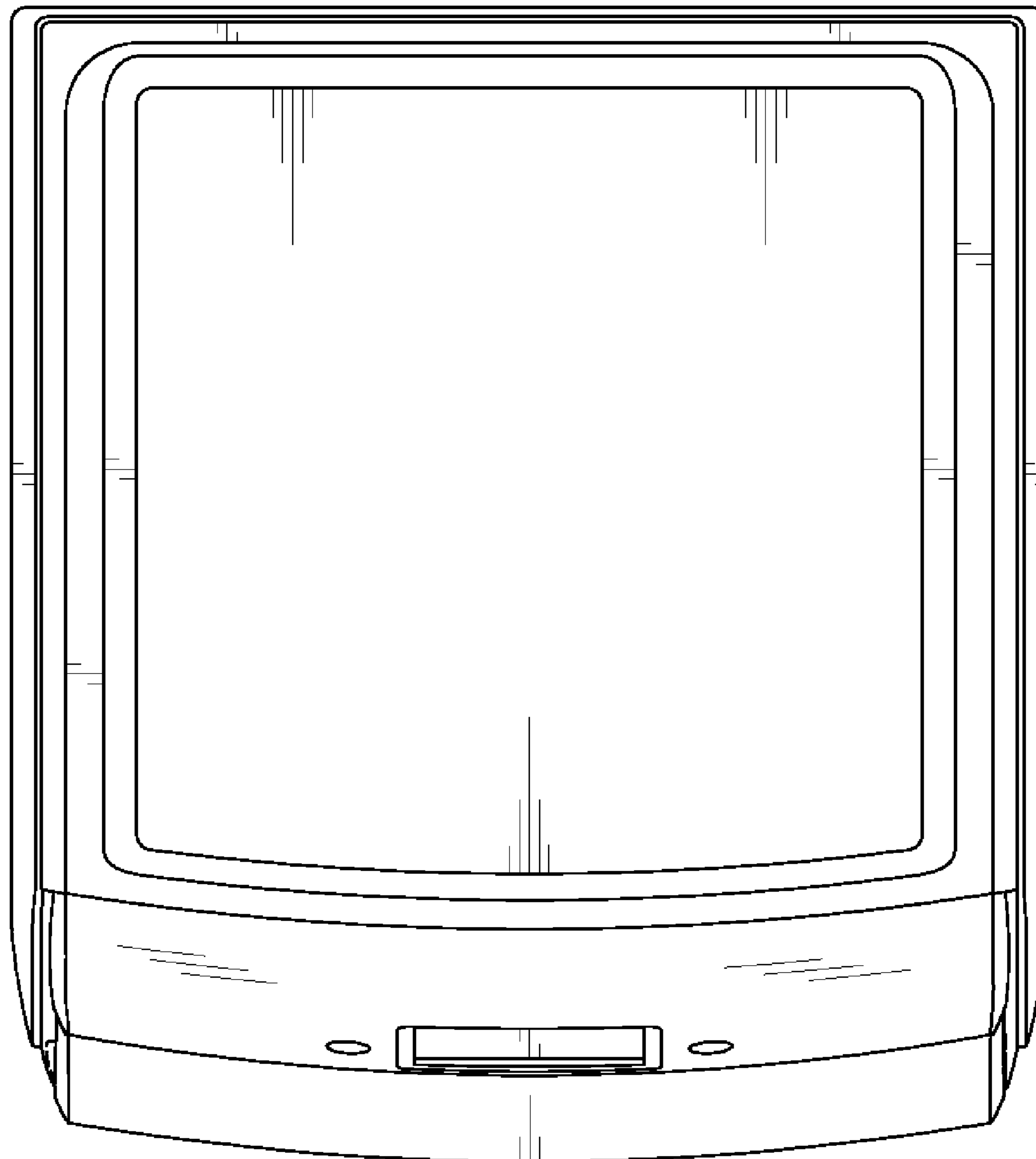

FIG. 7

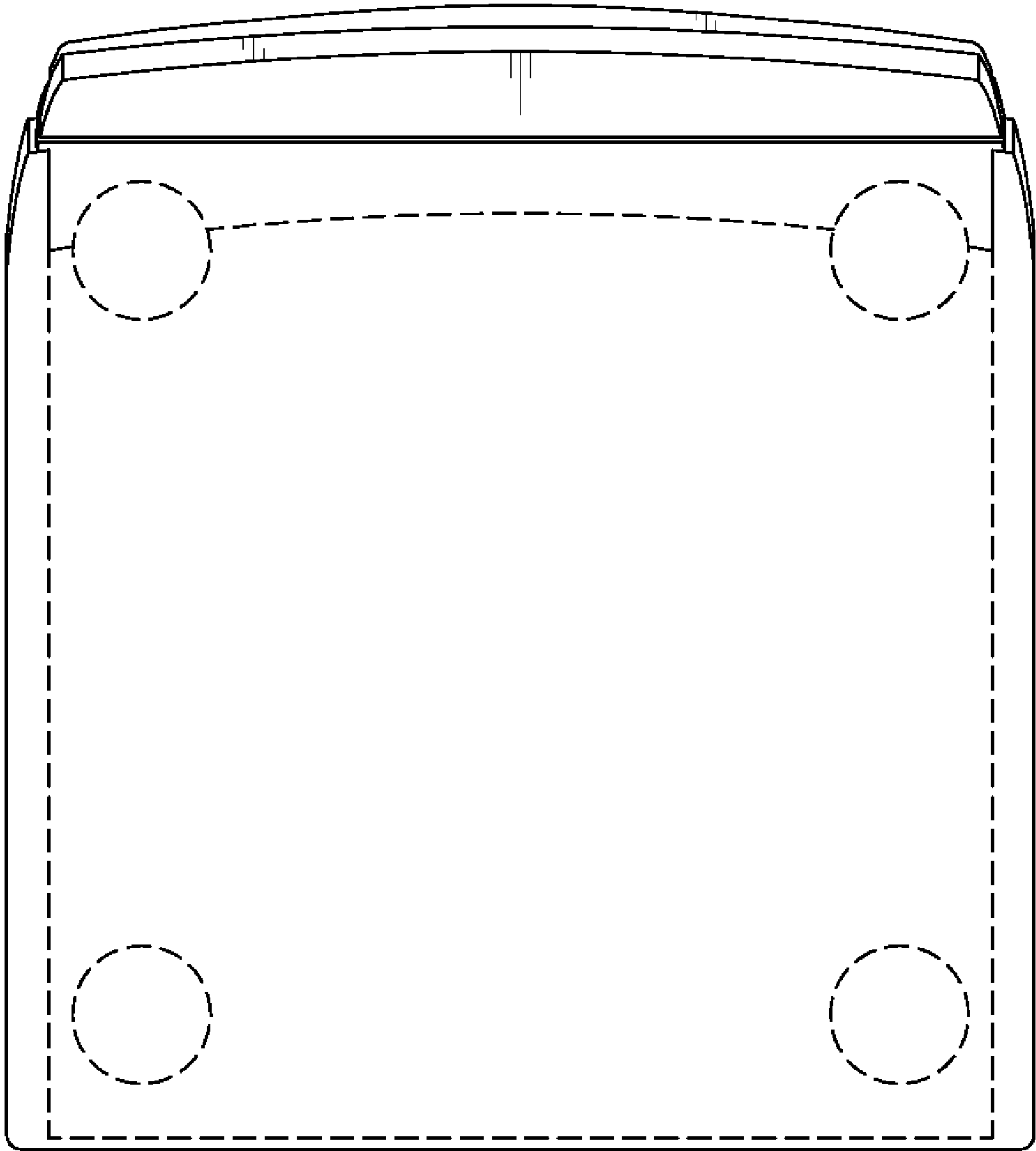

FIG. 8

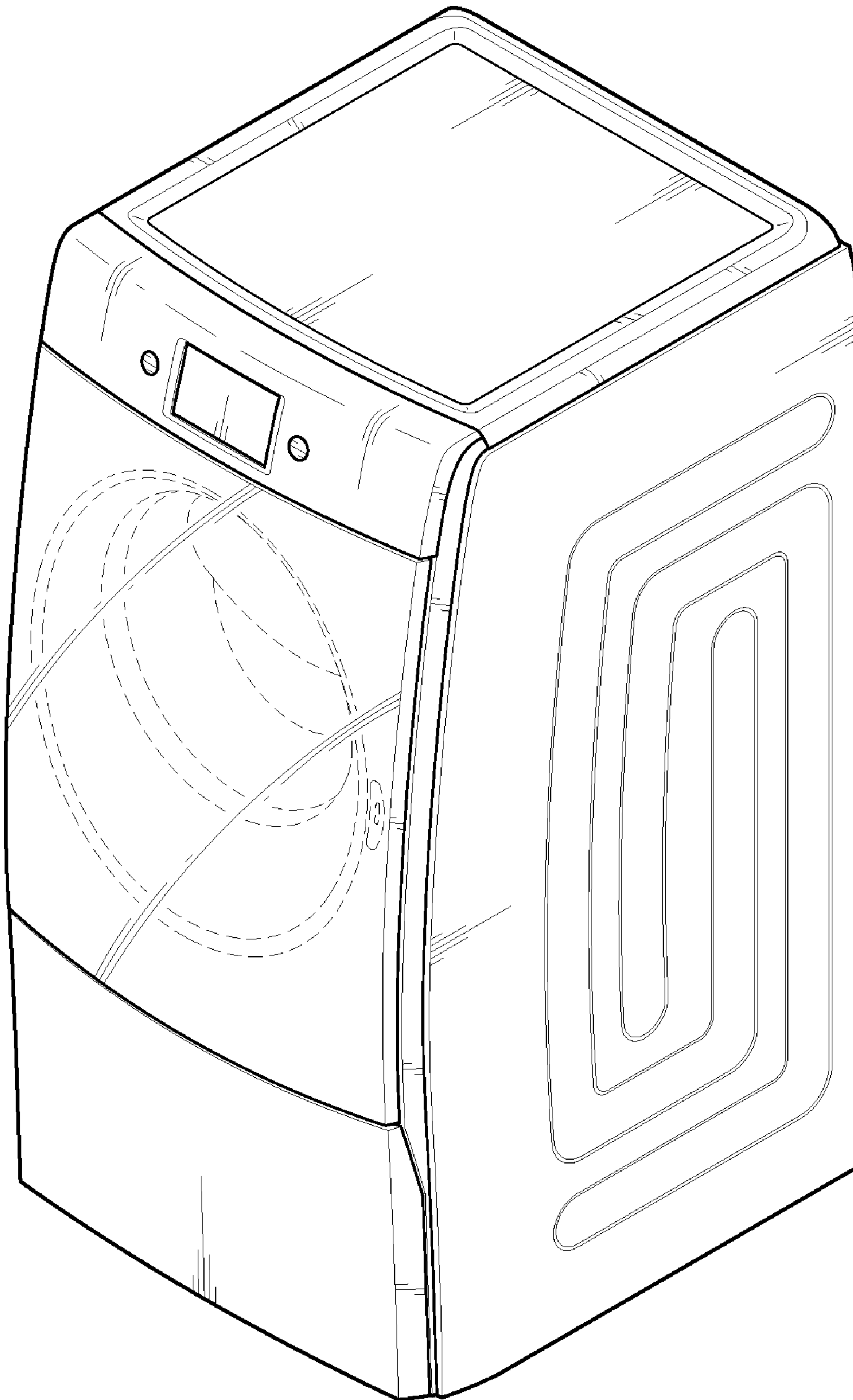

FIG. 9

