



US00D658191S

(12) **United States Design Patent**  
**Ruggiero**

(10) **Patent No.:** **US D658,191 S**

(45) **Date of Patent:** **\*\* Apr. 24, 2012**

(54) **ADJUSTABLE COMPUTER MONITOR ORGANIZING FRAME**

(76) Inventor: **Sal Ruggiero**, Palm Beach Gardens, FL (US)

(\*\*) Term: **14 Years**

(21) Appl. No.: **29/321,277**

(22) Filed: **Jul. 14, 2008**

(51) **LOC (9) Cl.** ..... **14-02**

(52) **U.S. Cl.** ..... **D14/450**

(58) **Field of Classification Search** ..... D14/448, D14/449, 450, 451, 452, 432, 439, 440, 305, D14/306, 307, 336, 339, 340, 356, 371, 372, D14/373, 374, 375, 376, 377, 378, 379, 380, D14/381, 382, 125, 126, 127, 128, 129, 239; D6/300, 308; D3/218, 271.2; D19/26, 27, D19/32, 33; 348/794, 832; 361/679.21; 248/917, 918, 919, 920, 921, 922, 923, 924, 248/442.2; 345/32, 609, 738; 349/58; 206/320; 40/765, 771

See application file for complete search history.

(56) **References Cited**

U.S. PATENT DOCUMENTS

D367,857	S	*	3/1996	Emmerik	.....	D14/450
D408,802	S	*	4/1999	Hernandez	.....	D14/439
5,956,100	A	*	9/1999	Gorski	.....	348/842
5,988,582	A	*	11/1999	Olivo	.....	248/442.2
6,412,744	B1	*	7/2002	Wollam et al.	.....	248/442.2
D463,439	S	*	9/2002	Olivo	.....	D14/448
6,443,415	B1	*	9/2002	Sundblad	.....	248/442.2
6,478,282	B1	*	11/2002	Flemming	.....	248/442.2

D508,054	S	*	8/2005	Ramsey	.....	D14/448
D508,695	S	*	8/2005	Vaughn	.....	D14/448
D509,221	S	*	9/2005	Suber et al.	.....	D14/448
6,983,919	B2	*	1/2006	Kroggel	.....	248/442.2
D522,007	S	*	5/2006	Cano	.....	D14/448

\* cited by examiner

*Primary Examiner* — Angela J Lee

(74) *Attorney, Agent, or Firm* — McHale & Slavin, P.A.

(57) **CLAIM**

The ornamental design for a adjustable computer monitor organizing frame, as shown and described.

**DESCRIPTION**

FIG. 1 is a front view of the adjustable computer monitor organizing frame of the instant invention depicting a computer monitor in phantom;

FIG. 2 is a front view of the adjustable computer monitor organizing frame;

FIG. 3 is a rear view thereof, but shown without the extension legs for clarity of illustration;

FIG. 4 is a perspective view thereof where the extension legs are in a detached position;

FIG. 5 is an exploded rear perspective view illustrating extension legs;

FIG. 6 is an end view of a right component of the frame, shown separately for clarity of illustration;

FIG. 7 is an end view of a left component of the frame, shown separately for clarity of illustration;

FIG. 8 is a front view of the extension legs; and,

FIG. 9 is an exploded rear perspective view without extension legs.

The broken lines shown in the figures (portions of the design shown in broken/dashed lines) are included for the purpose of illustrating environment and form no part of the claimed design.

**1 Claim, 8 Drawing Sheets**

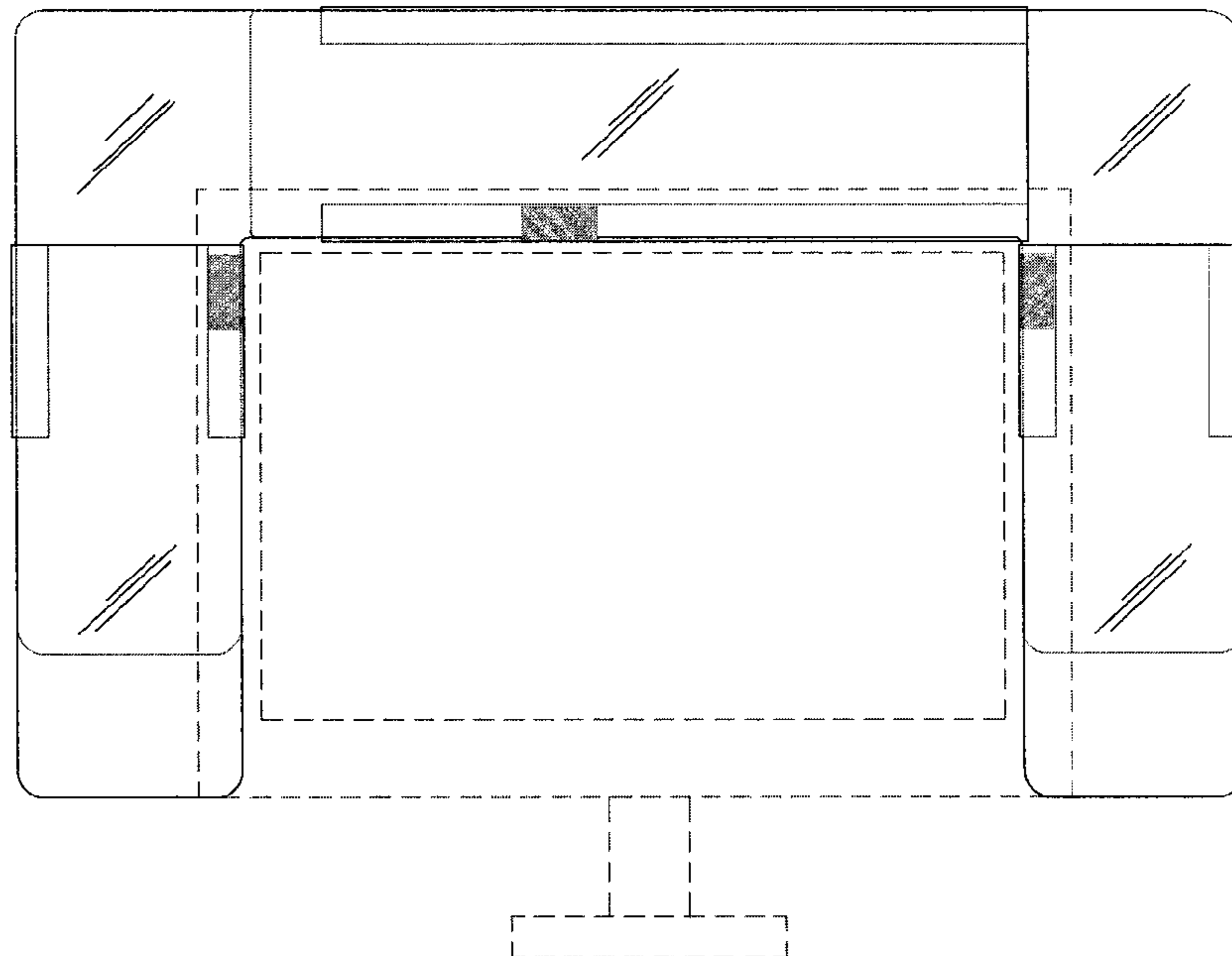

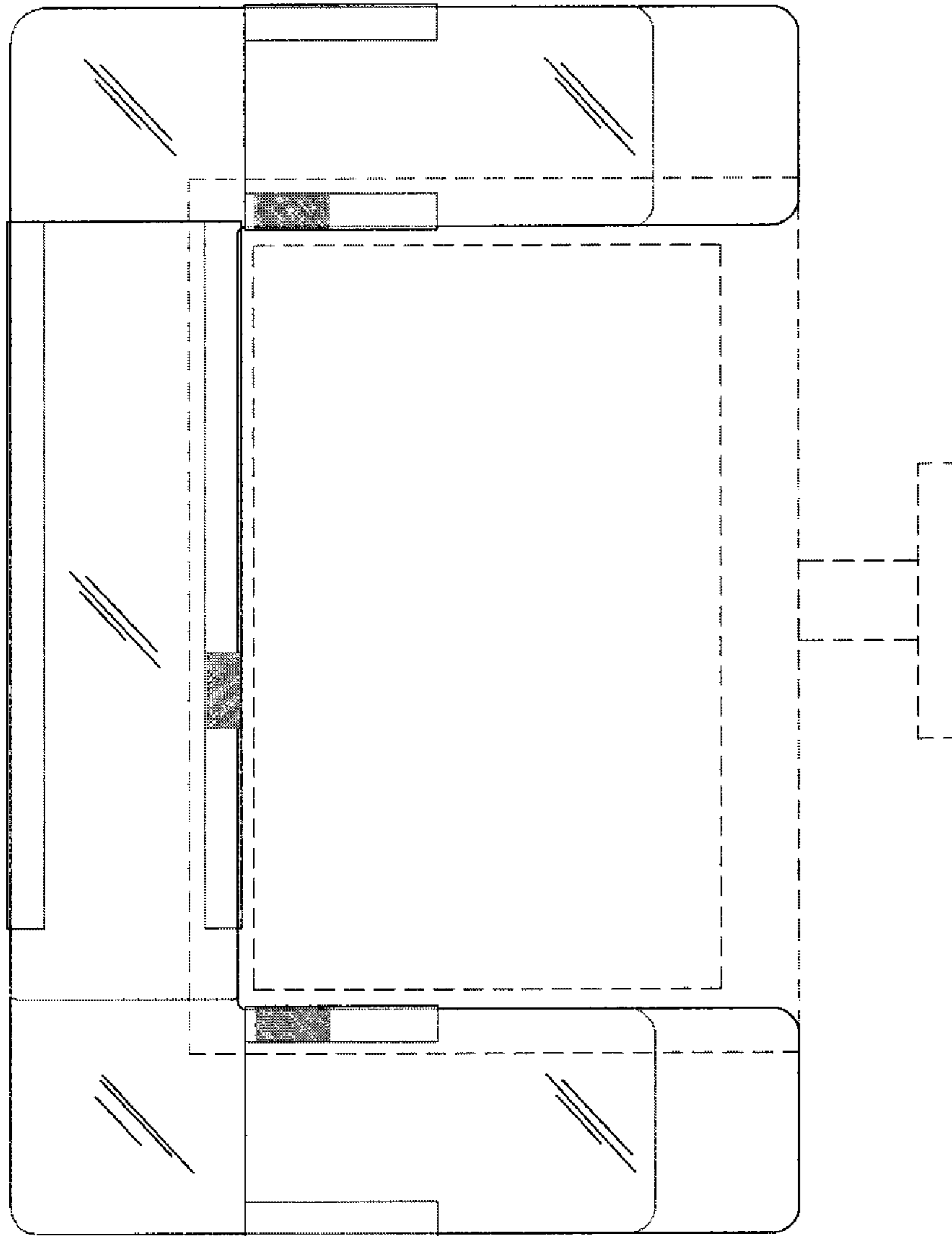

**FIG. 1**

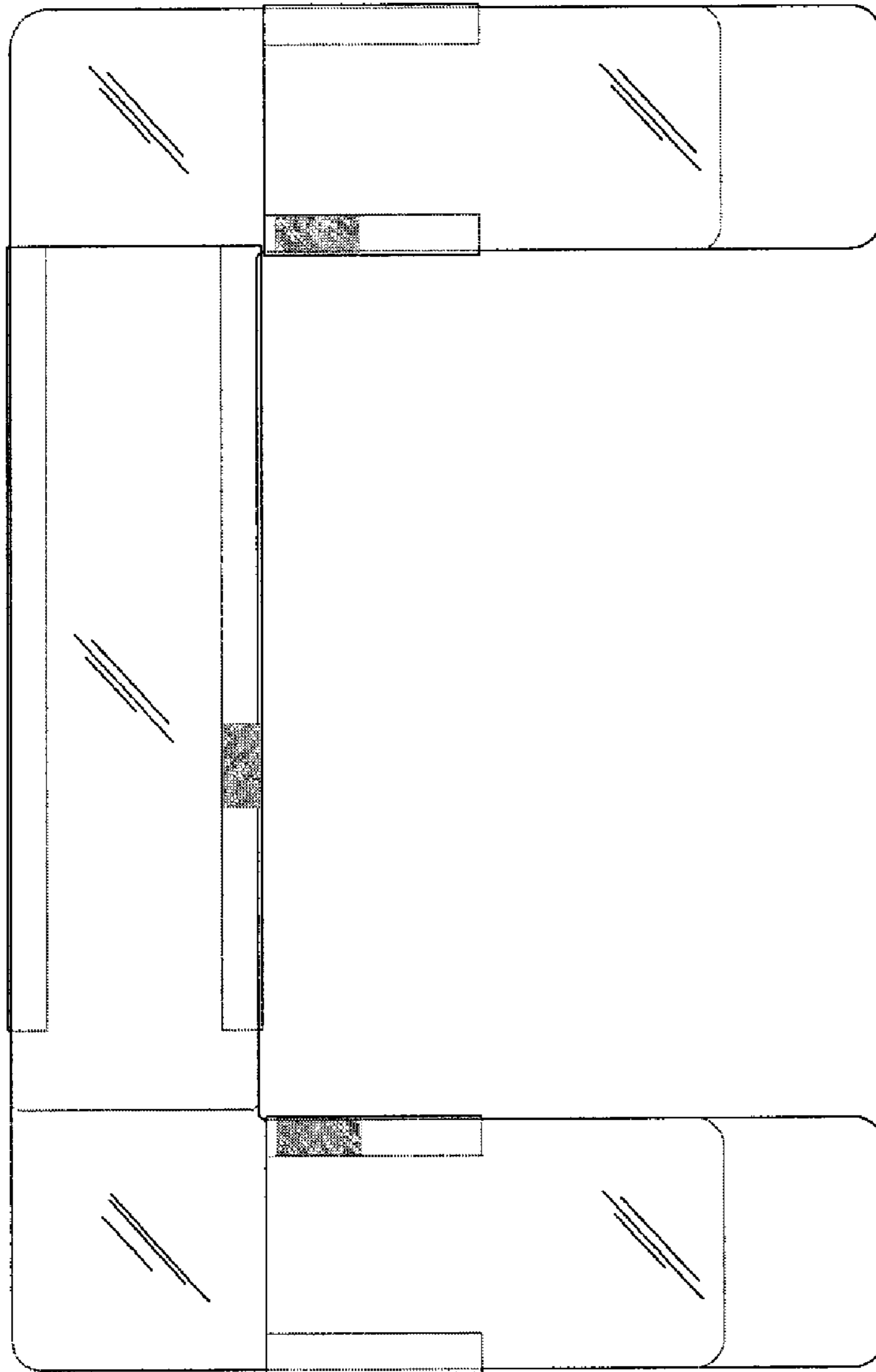

FIG. 2

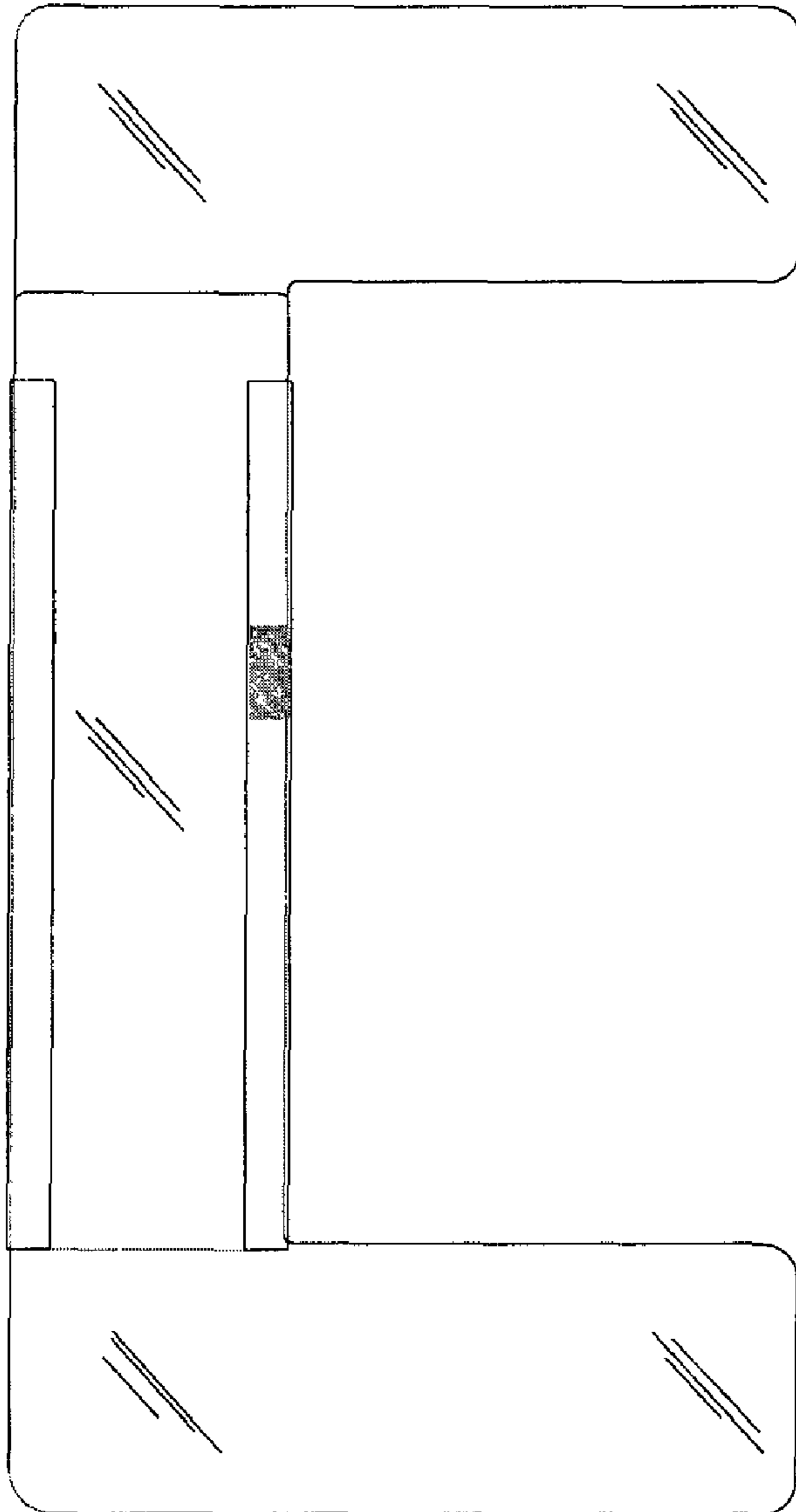
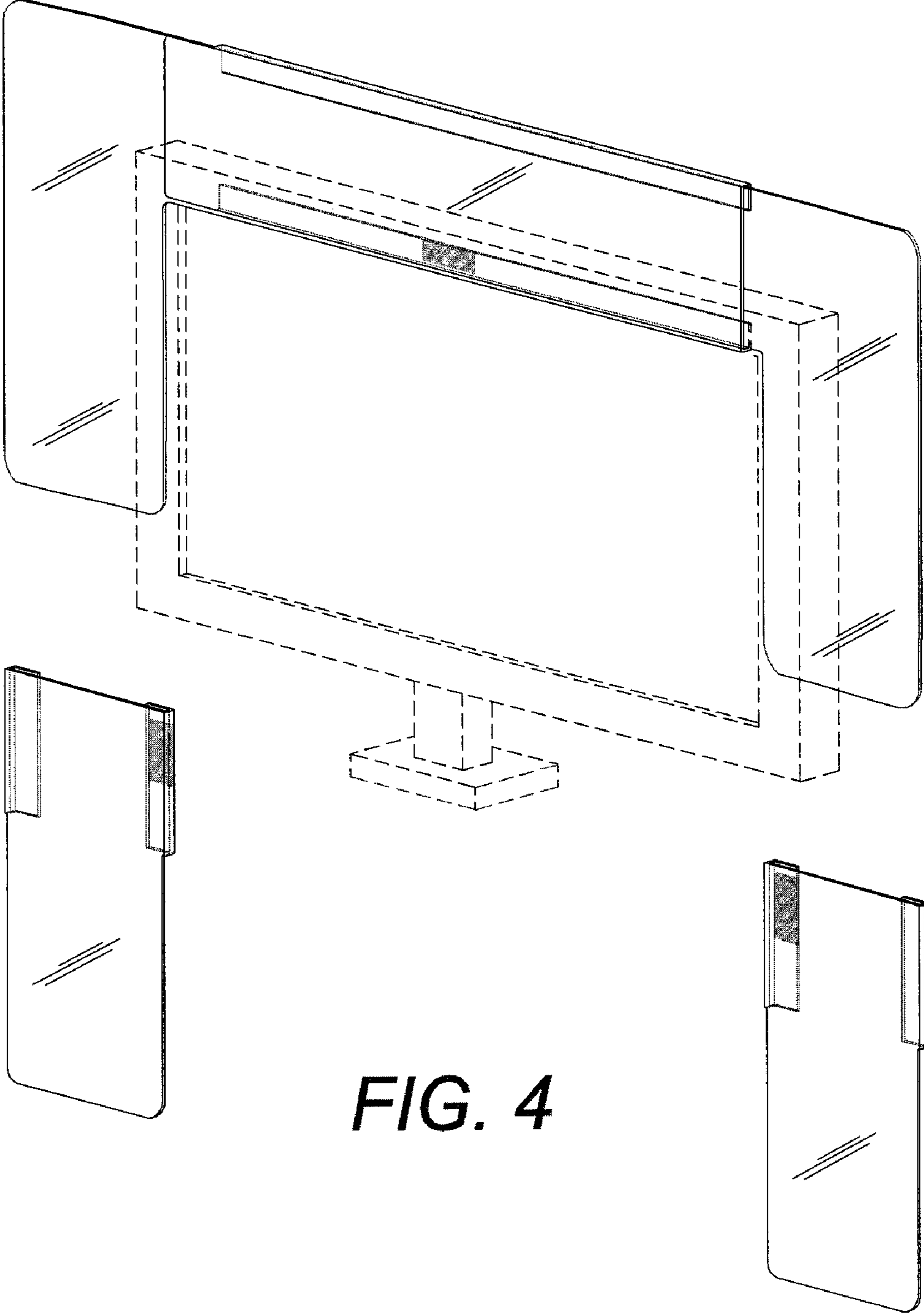

FIG. 3



**FIG. 4**

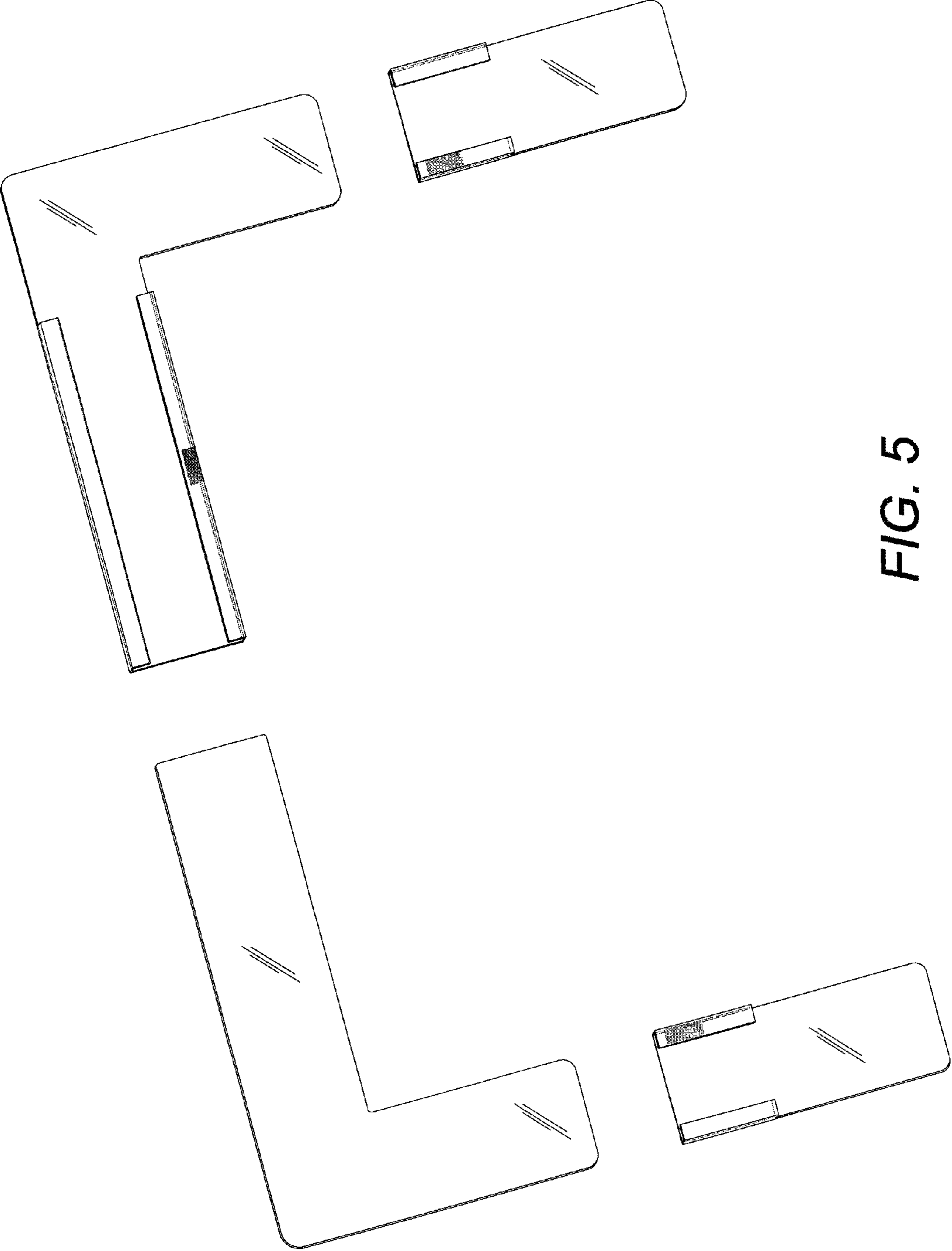
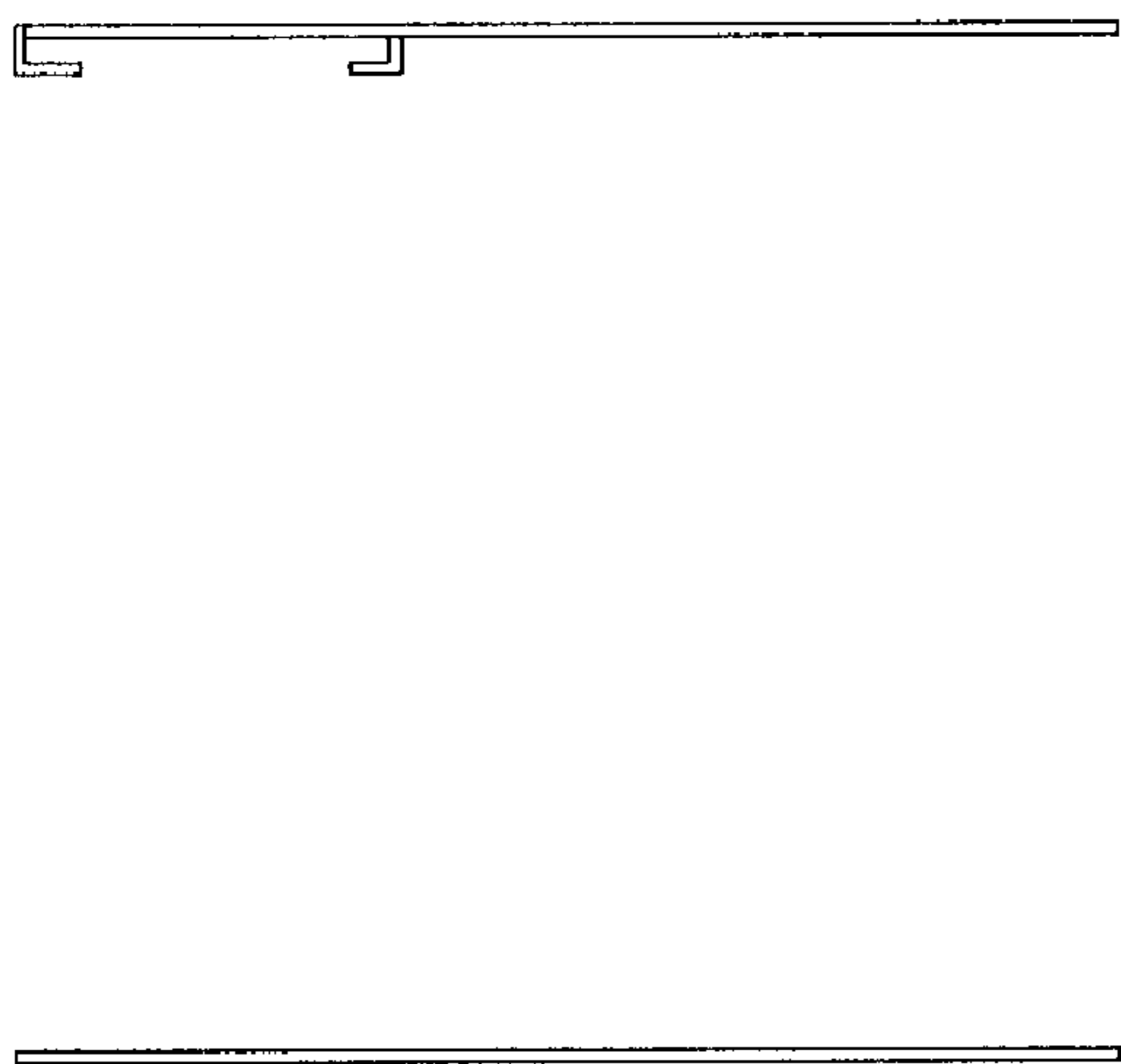

FIG. 5



**FIG. 6**      **FIG. 7**

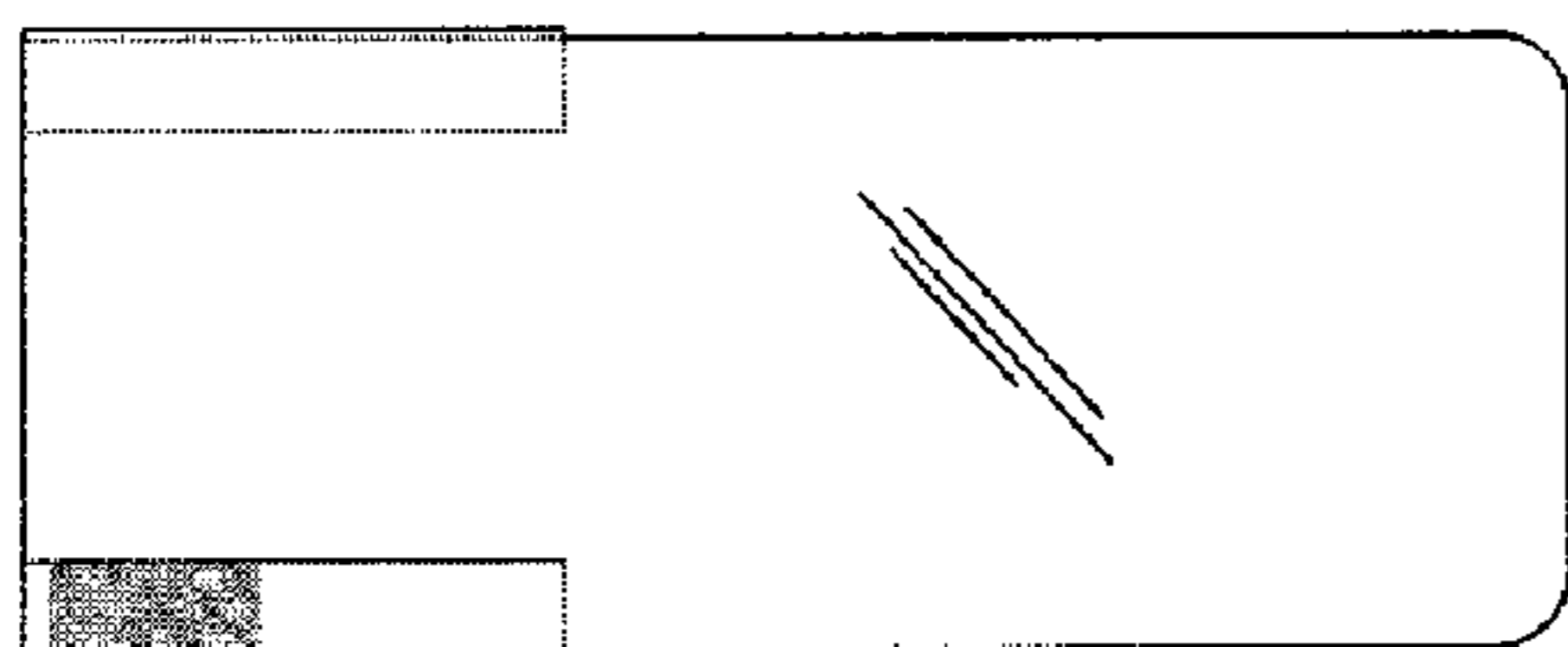
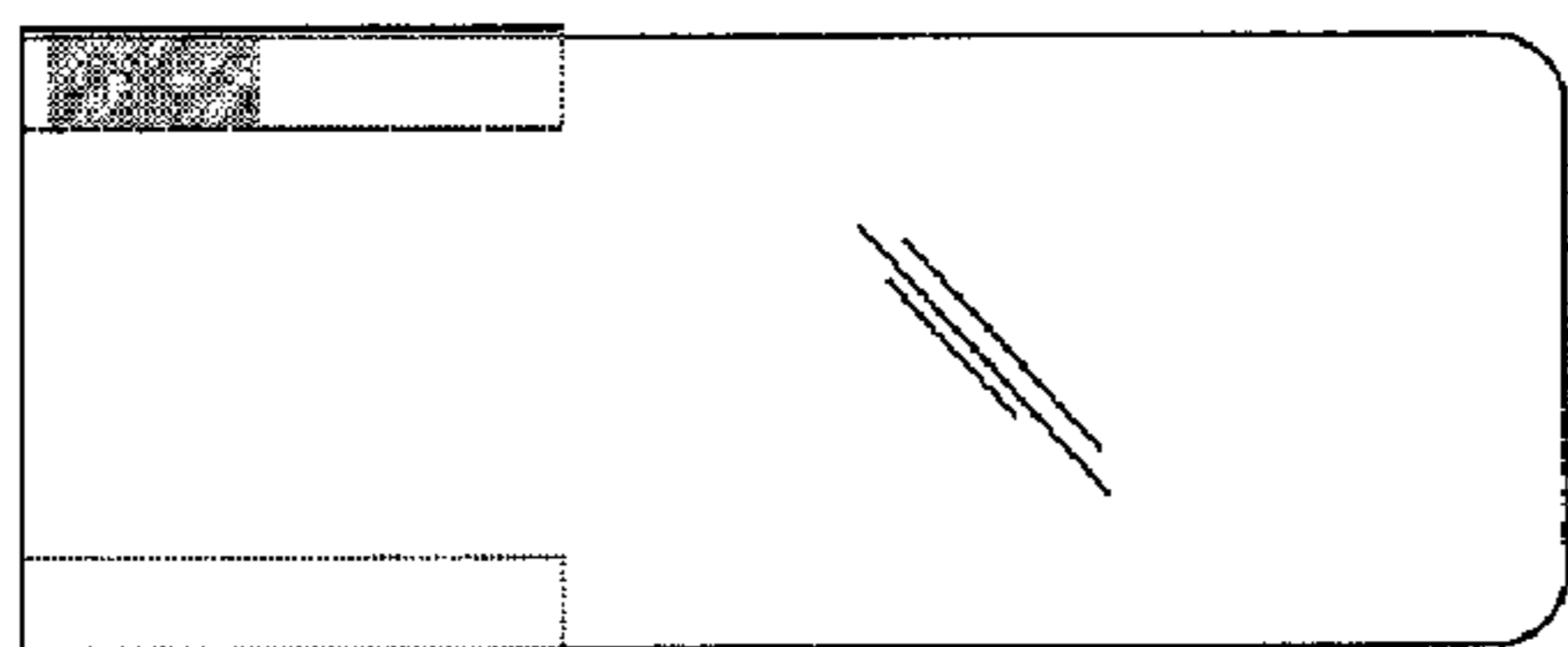

FIG. 8



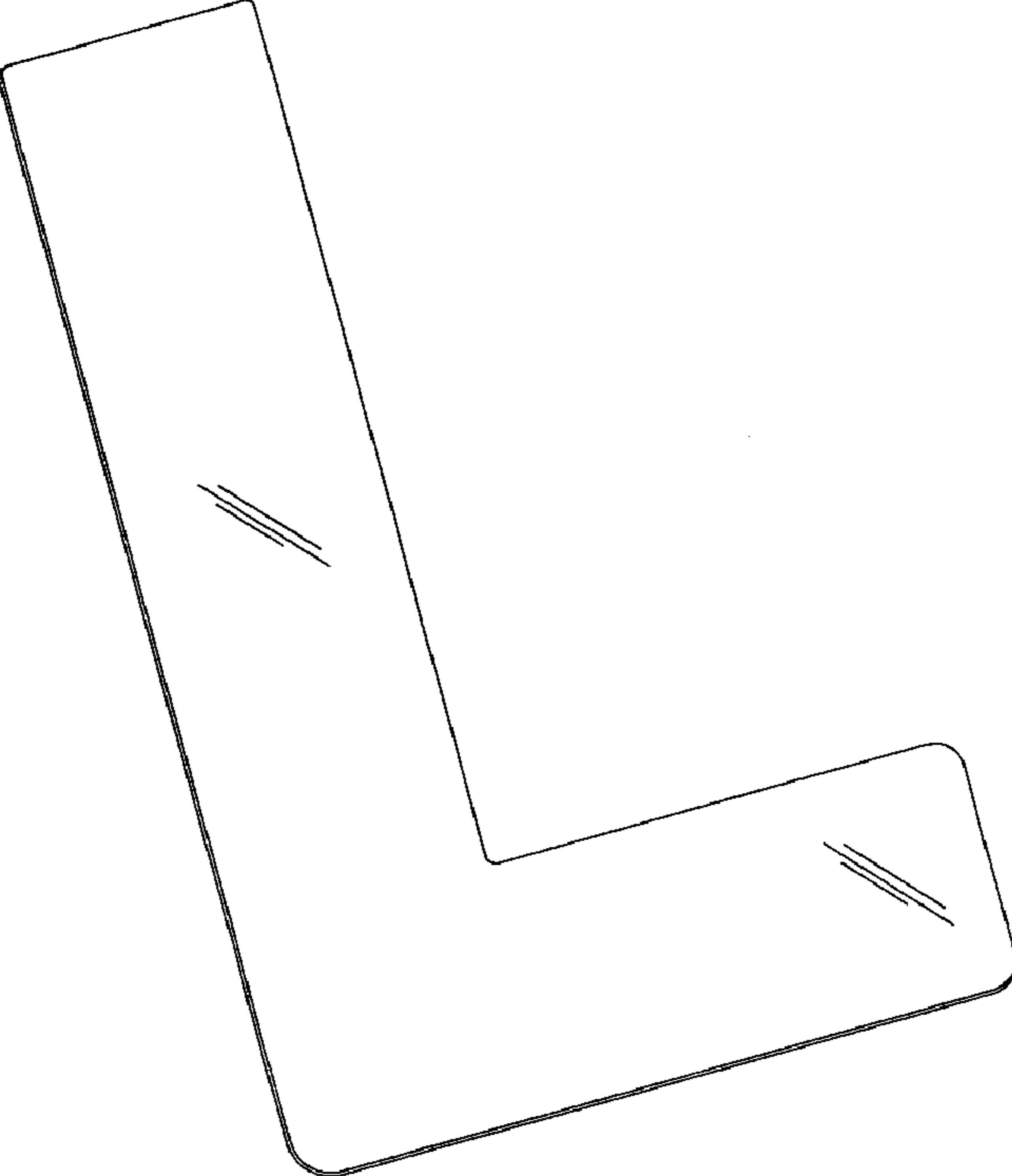
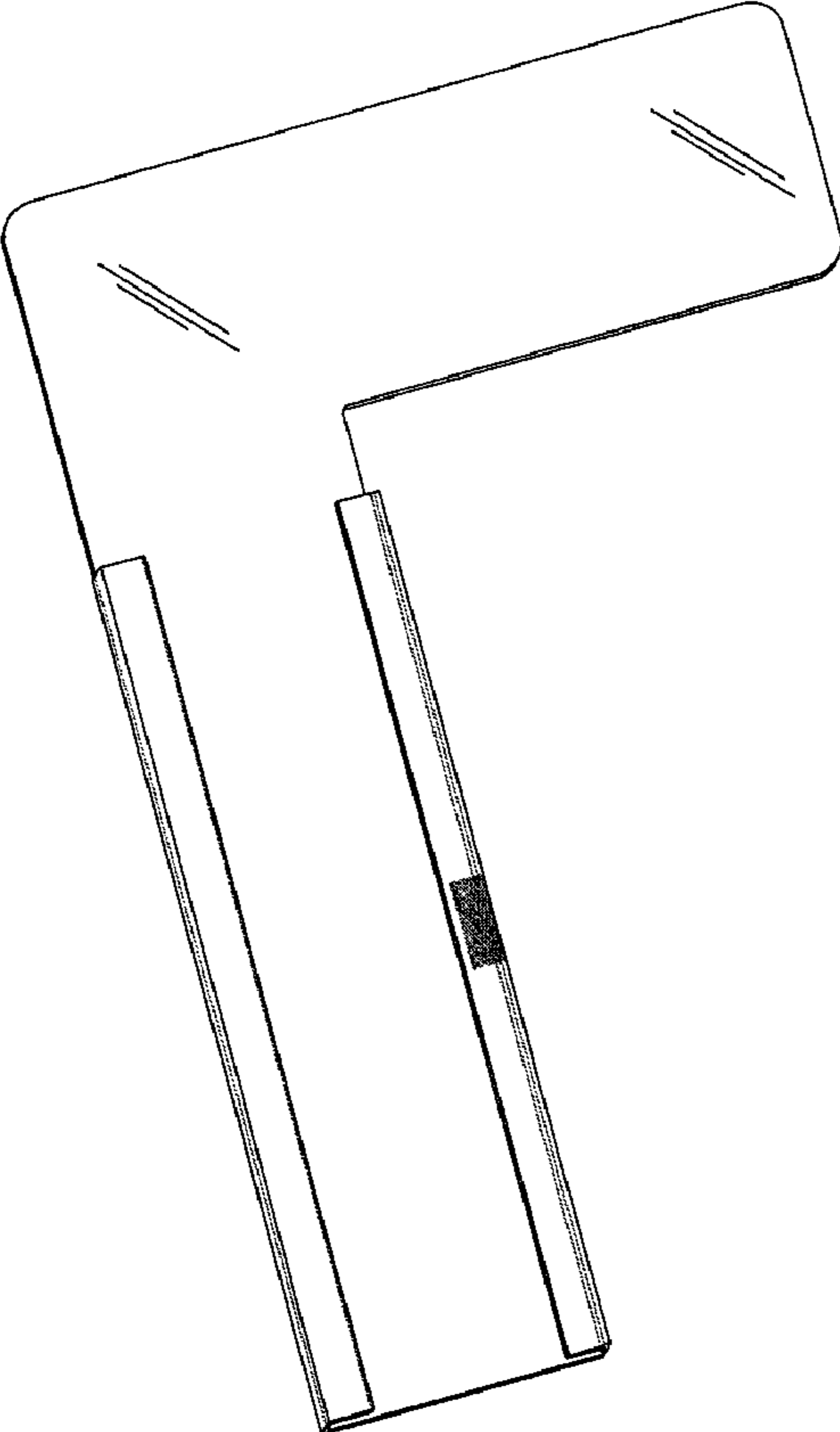

FIG. 9