



US00D658181S

(12) **United States Design Patent**  
**Kim et al.**

(10) **Patent No.:** **US D658,181 S**

(45) **Date of Patent:** **\*\* Apr. 24, 2012**

(54) **ELECTRONIC MOUSE**

(75) Inventors: **Young Soo Kim**, Seattle, WA (US);  
**Peter Bristol**, Shoreline, WA (US);  
**Curtis Aumiller**, Redmond, WA (US)

(73) Assignee: **Microsoft Corporation**, Redmond, WA (US)

(\*\*) Term: **14 Years**

(21) Appl. No.: **29/410,508**

(22) Filed: **Jan. 9, 2012**

(51) **LOC (9) Cl.** ..... **14-02**

(52) **U.S. Cl.** ..... **D14/407**

(58) **Field of Classification Search** ..... D14/402-411,  
D14/356, 388, 389, 383-385, 417, 426;  
345/156-167; 463/36-38; 358/471, 473;  
273/148 B

See application file for complete search history.

(56) **References Cited**

**U.S. PATENT DOCUMENTS**

D120,157 S *	4/1940	Giannini	.....	D14/229
D190,202 S *	4/1961	Hirsch	.....	D14/168
4,803,743 A *	2/1989	Greenawalt	.....	5/636
5,638,564 A *	6/1997	Greenawalt et al.	.....	5/636
D417,668 S *	12/1999	Tanaka	.....	D14/214
D431,230 S *	9/2000	Began	.....	D13/184
D460,071 S *	7/2002	Sheehan et al.	.....	D14/402
D470,826 S *	2/2003	Bergmann	.....	D13/184
D528,080 S *	9/2006	Wells	.....	D14/125

D530,273 S *	10/2006	Solland	.....	D13/108
D535,981 S *	1/2007	Park	.....	D14/230
D568,870 S *	5/2008	Anthony et al.	.....	D14/214
D572,704 S *	7/2008	Chang	.....	D14/214
D580,435 S *	11/2008	Huang et al.	.....	D14/356
D583,813 S *	12/2008	Maiers et al.	.....	D14/356
D587,706 S *	3/2009	Maiers et al.	.....	D14/356
D607,881 S *	1/2010	Suetake et al.	.....	D14/227
D626,126 S *	10/2010	Park	.....	D14/365
D636,757 S *	4/2011	Yoshiizumi	.....	D14/214
D644,202 S *	8/2011	Park et al.	.....	D14/214

\* cited by examiner

*Primary Examiner* — Austin Murphy

(74) *Attorney, Agent, or Firm* — Banner & Witcoff, Ltd.

(57) **CLAIM**

The ornamental design for an electronic mouse, as shown and described.

**DESCRIPTION**

FIG. 1 is a rear perspective view of an electronic mouse showing the new design;

FIG. 2 is a rear view thereof;

FIG. 3 is a front view thereof;

FIG. 4 is a left side view thereof;

FIG. 5 is a right side view thereof;

FIG. 6 is a top view thereof;

FIG. 7 is a bottom view thereof; and,

FIG. 8 is a front perspective view thereof.

The broken line showing of the remainder of the electronic mouse in FIGS. 2-5 and FIG. 7 are for environmental purposes only and forms no part of the claimed design.

**1 Claim, 8 Drawing Sheets**

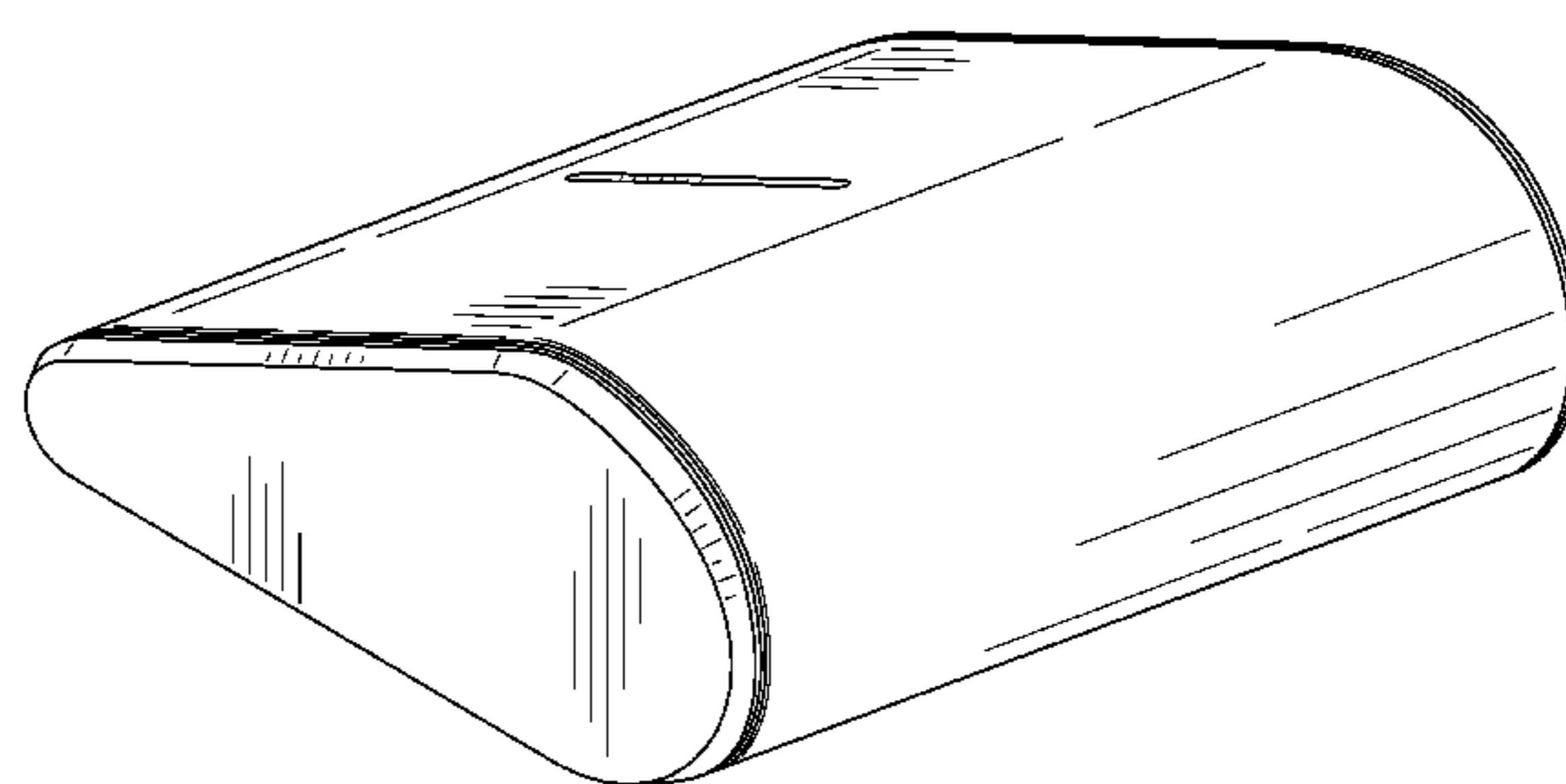
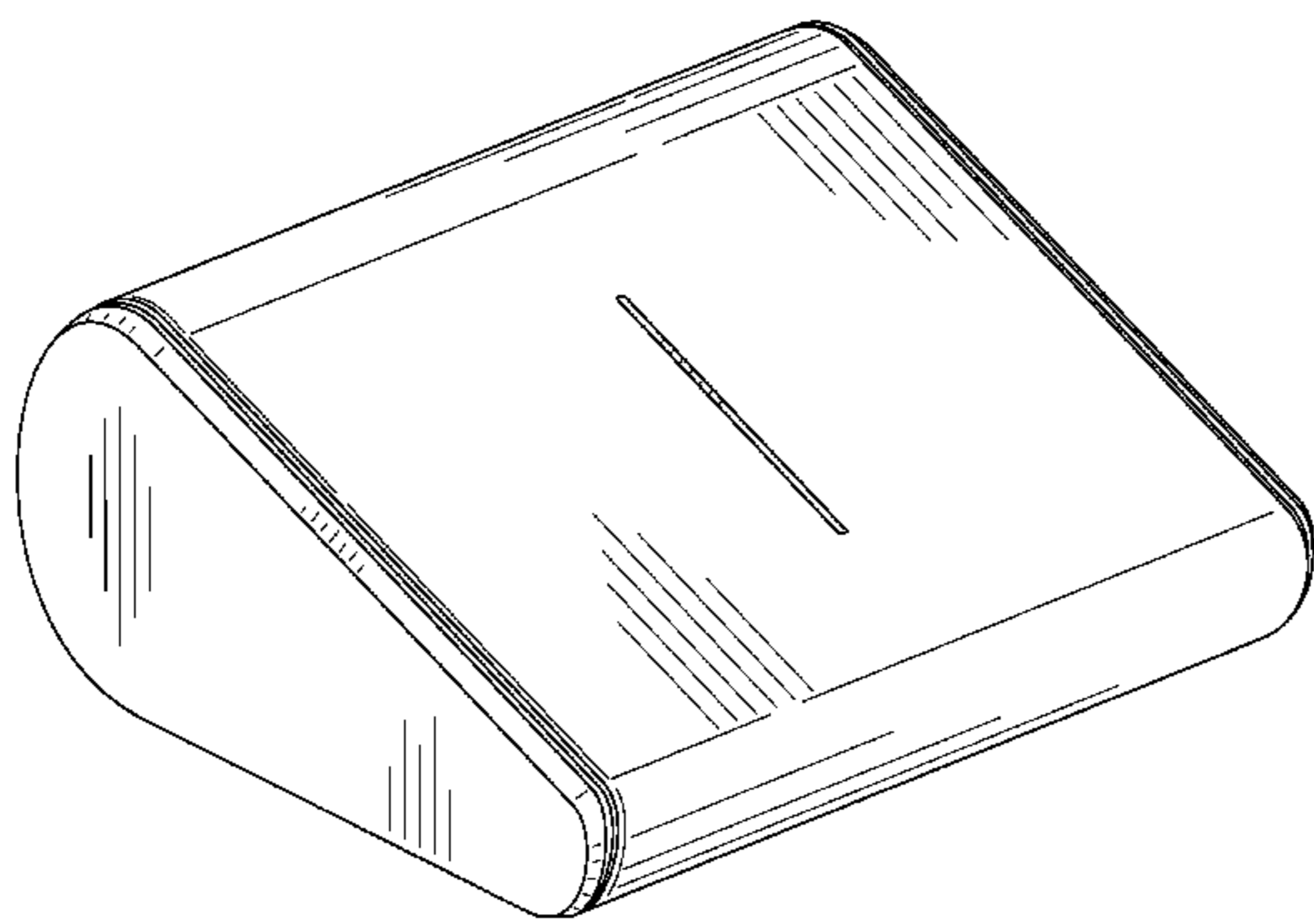

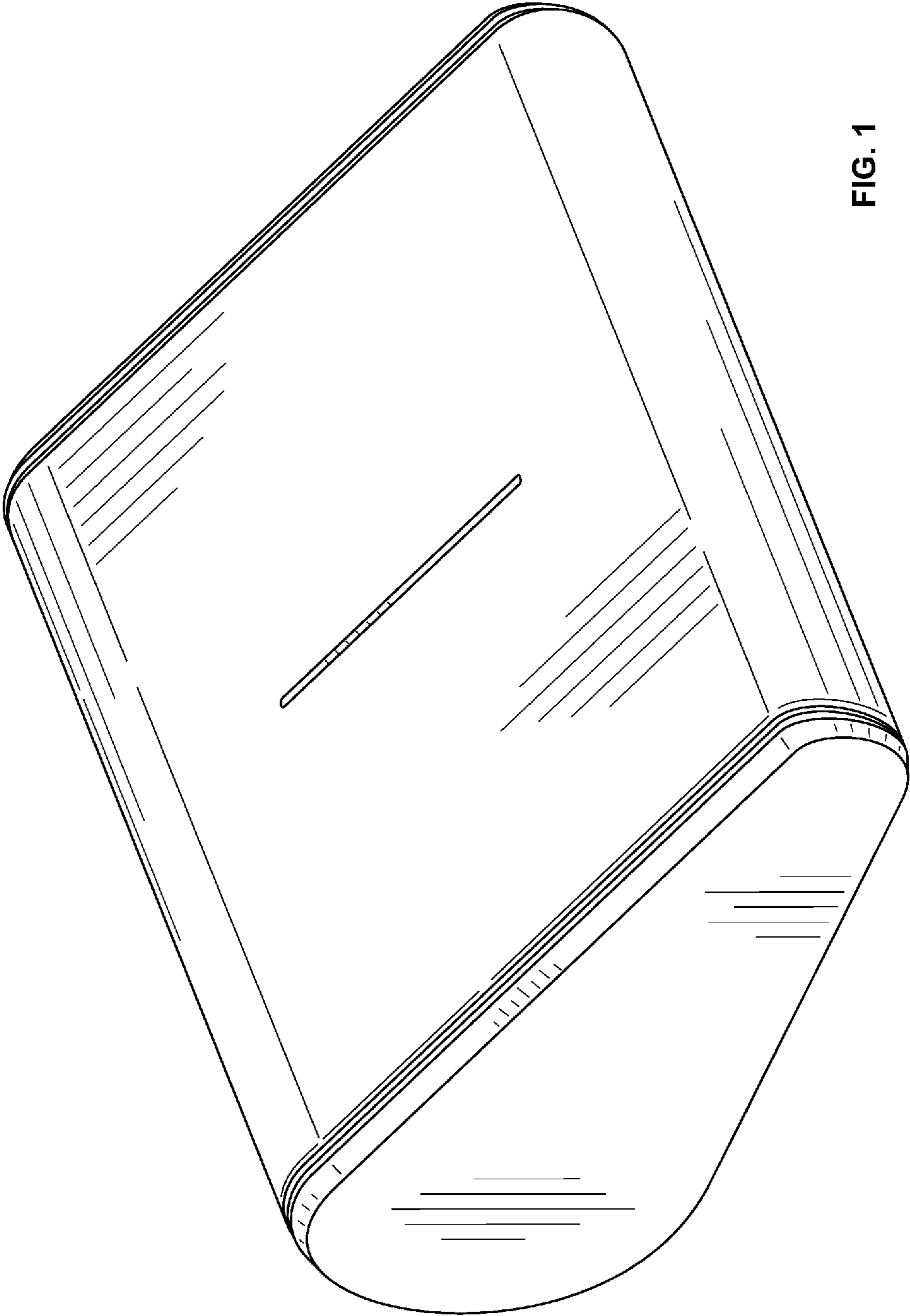

FIG. 1

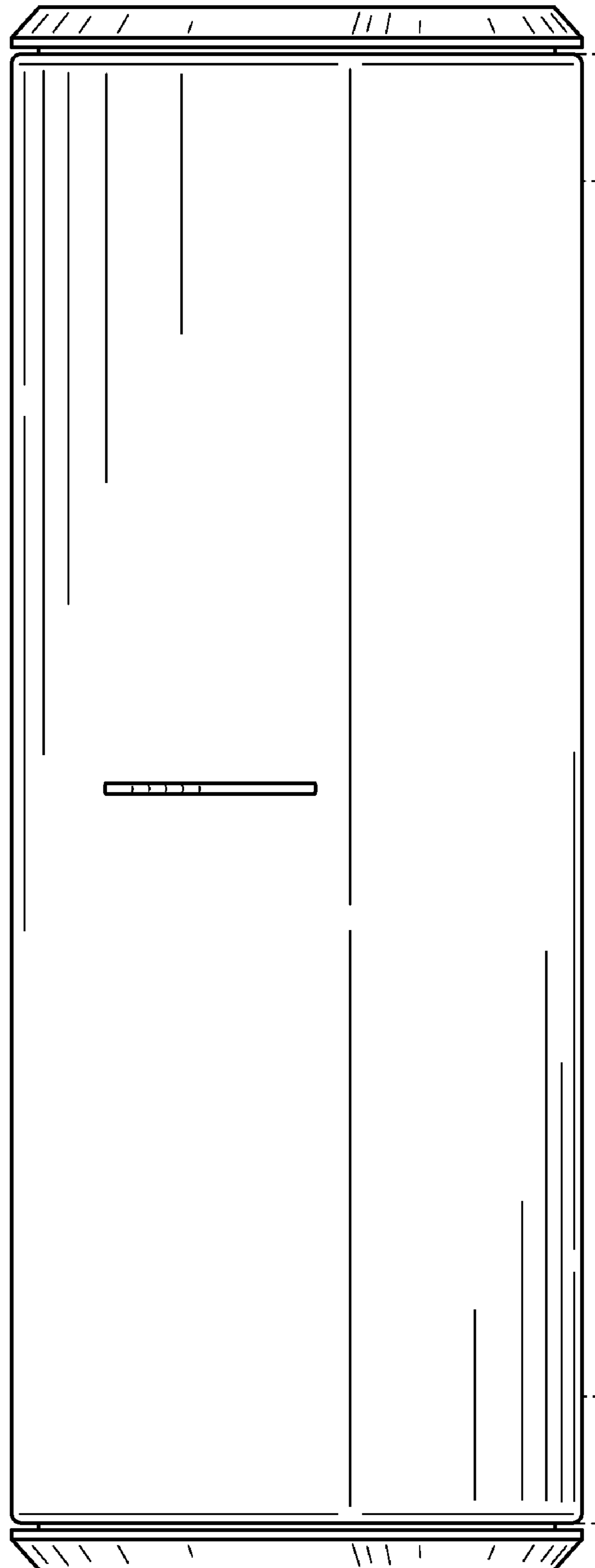

FIG. 2

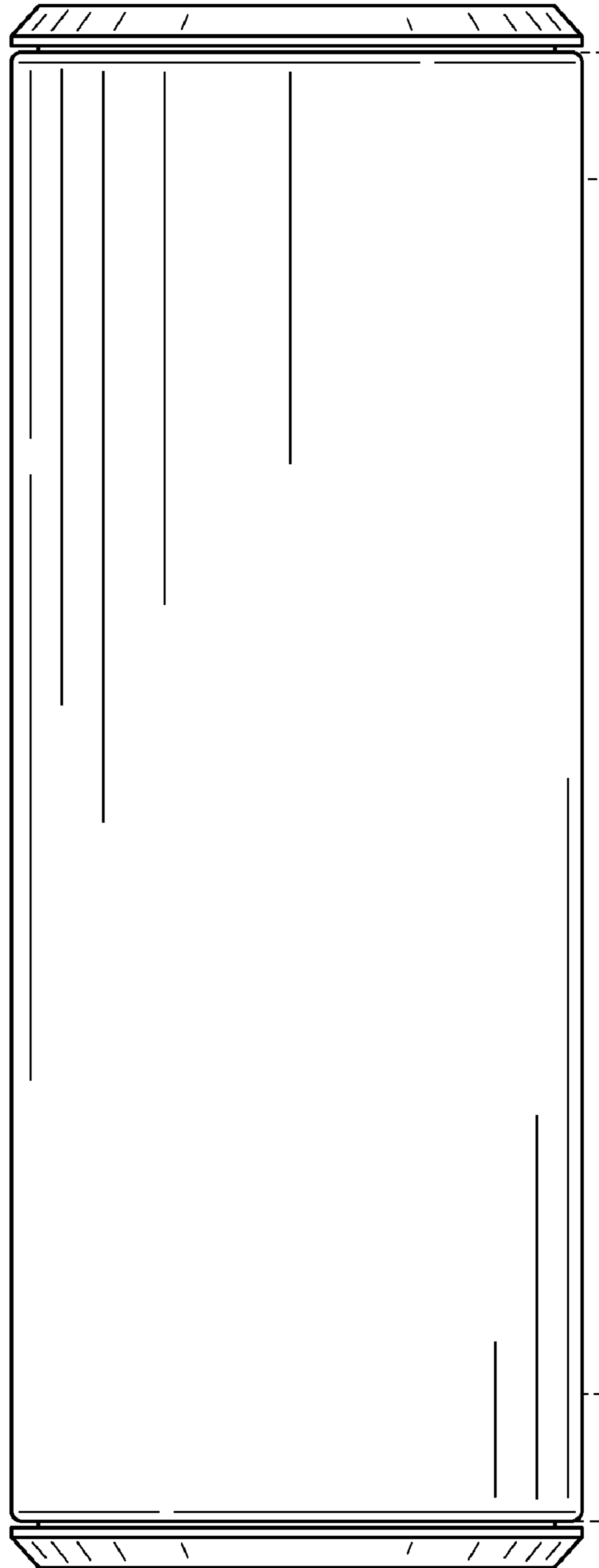

FIG. 3

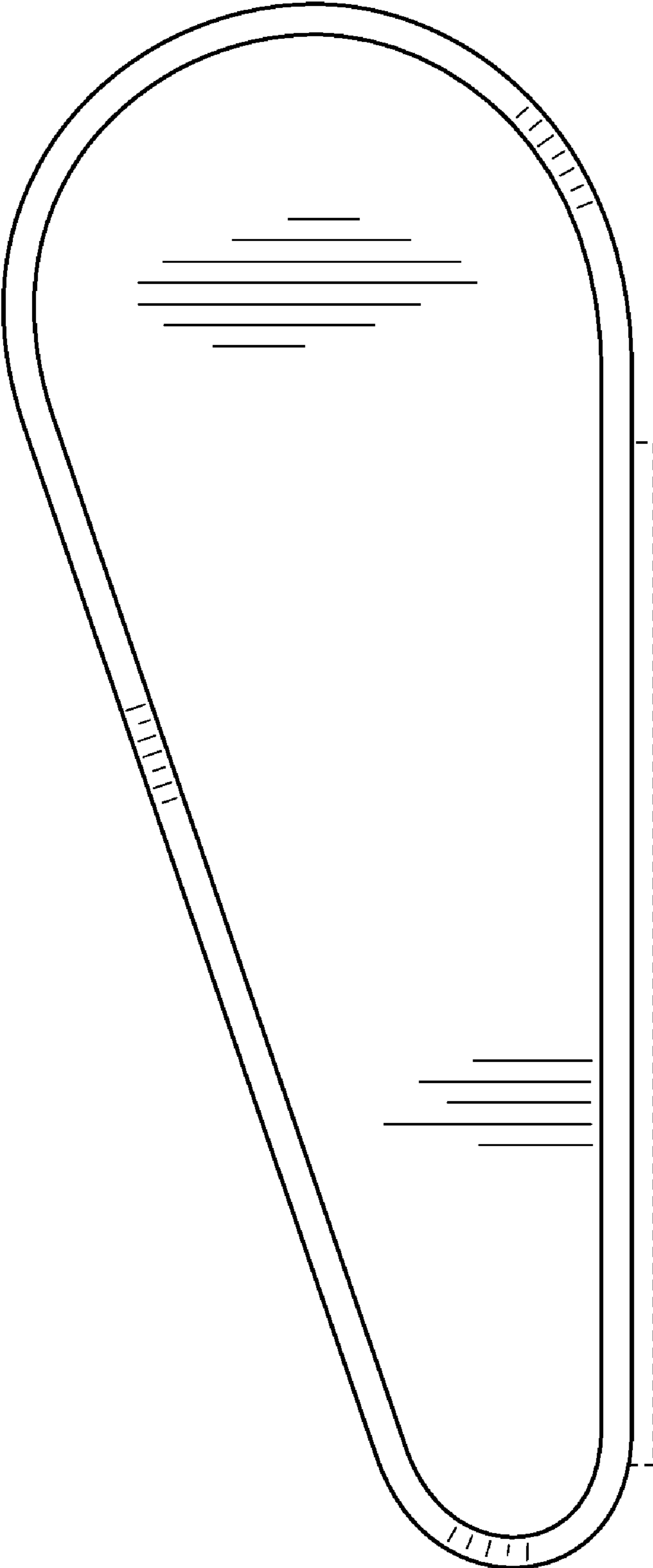

FIG. 4

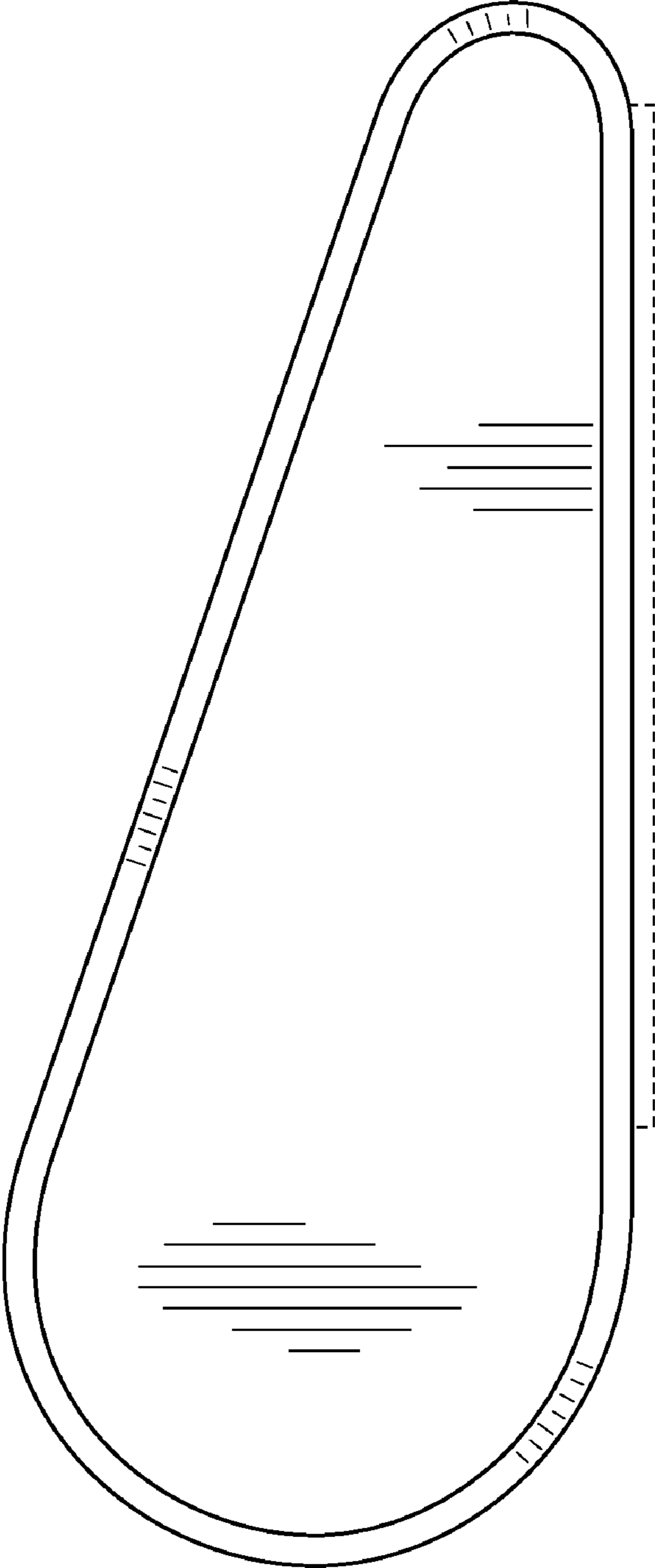

FIG. 5

FIG. 6

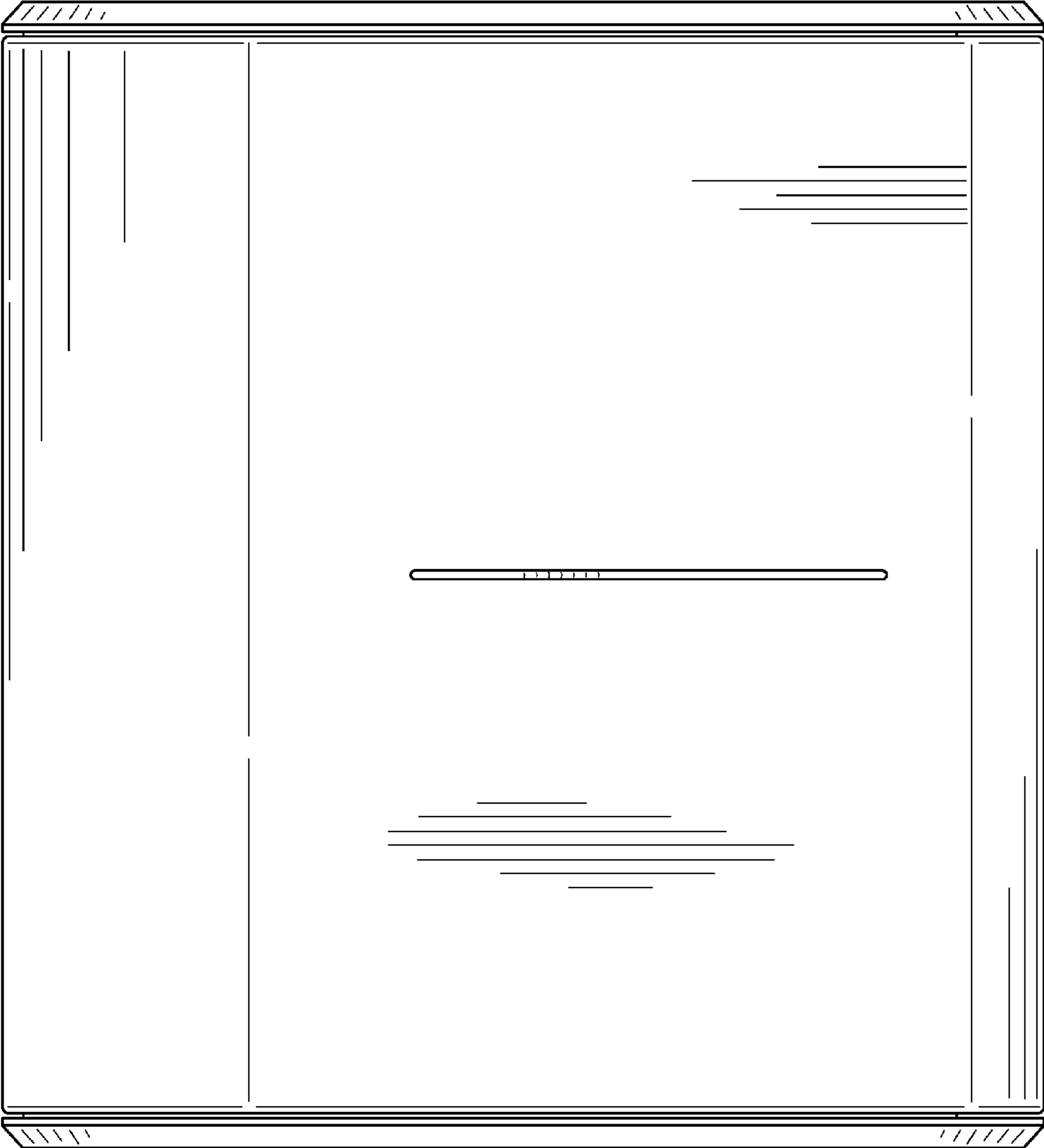
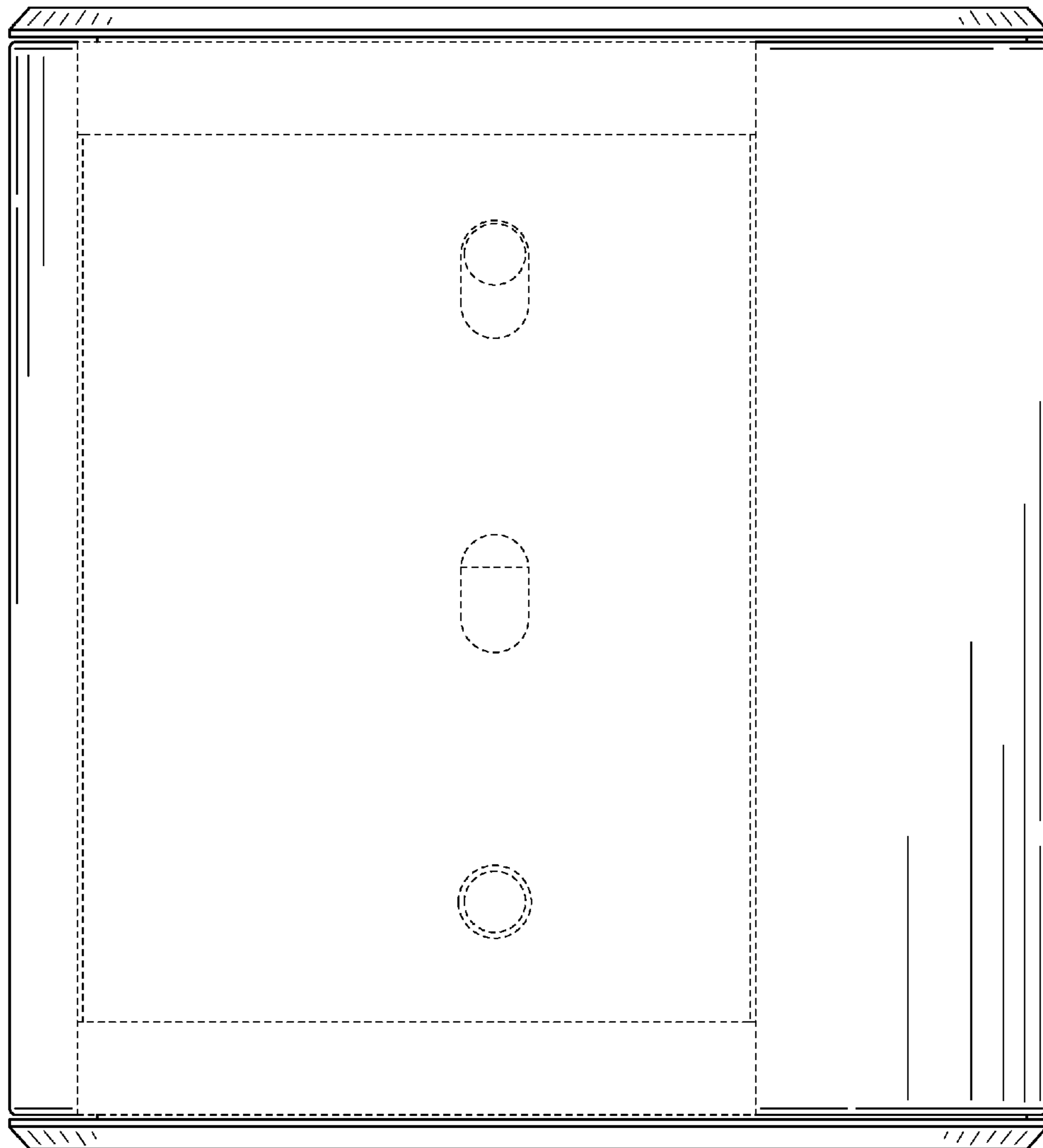

FIG. 7





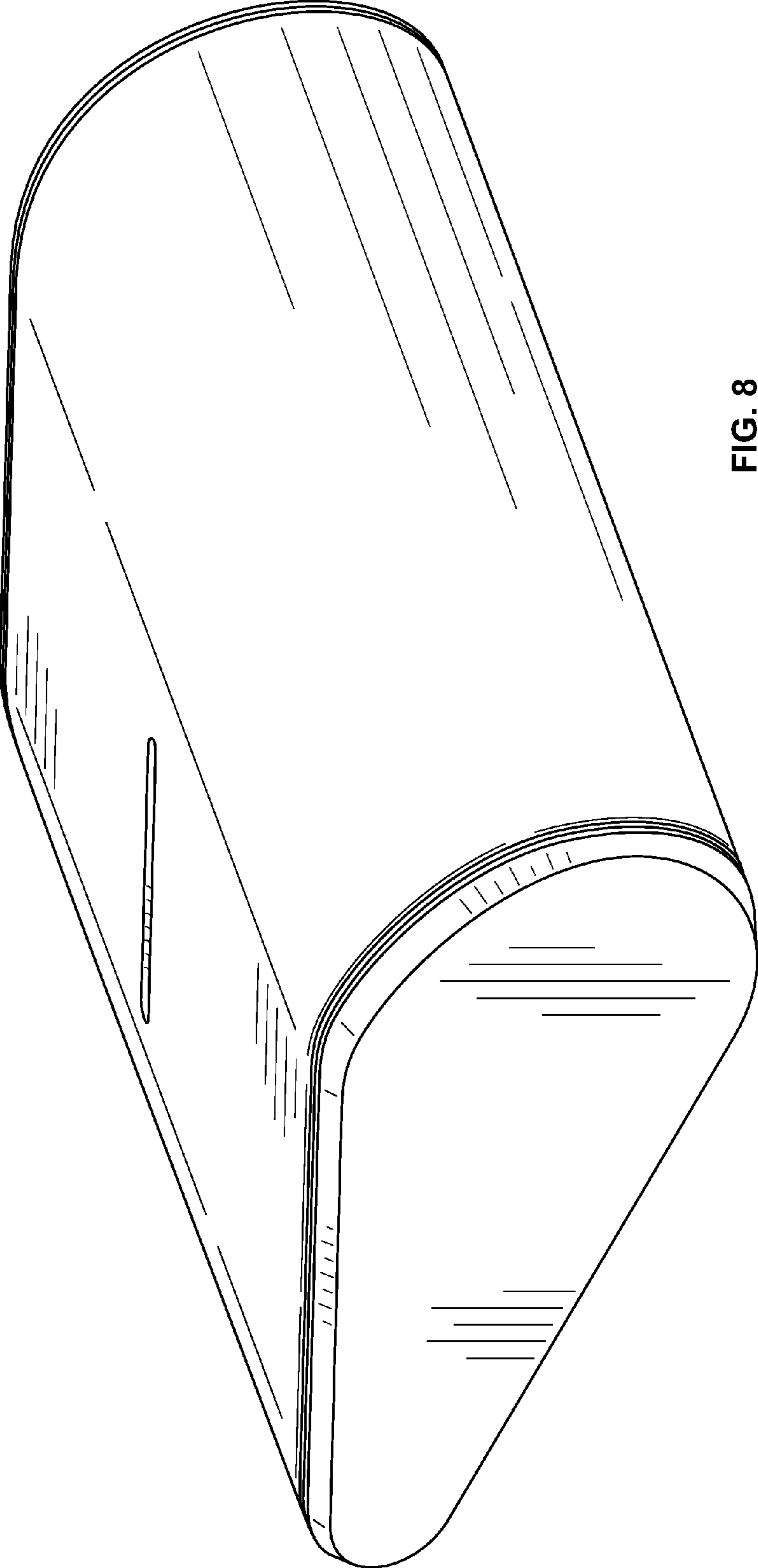

FIG. 8