



US00D658122S

(12) **United States Design Patent**
Tsoi

(10) **Patent No.:** **US D658,122 S**

(45) **Date of Patent:** **** Apr. 24, 2012**

(54) **SWITCHING POWER SUPPLY WITH CHANGEABLE PLUGS**

(75) Inventor: **Chun Chun Tsoi**, New Territories (HK)

(73) Assignee: **Eastern Frontier Co., Ltd.**, Kowloon (HK)

(**) Term: **14 Years**

(21) Appl. No.: **29/292,466**

(22) Filed: **Oct. 12, 2007**

(51) **LOC (9) Cl.** **13-02**

(52) **U.S. Cl.** **D13/108**

(58) **Field of Classification Search** D13/107,
D13/110, 118–119, 138.1, 138.2, 184; D14/251,
D14/253, 432, 434; 320/107–115

See application file for complete search history.

(56) **References Cited**

U.S. PATENT DOCUMENTS

D378,290	S	*	3/1997	Hahn	D13/138.2
D378,291	S	*	3/1997	Hahn	D13/138.2
5,611,701	A	*	3/1997	Hahn	439/131
5,613,863	A	*	3/1997	Klaus et al.	439/131
D379,003	S	*	4/1997	Hahn	D13/138.1
6,086,395	A	*	7/2000	Lloyd et al.	439/172
6,227,888	B1	*	5/2001	Hahn	439/173
6,261,109	B1	*	7/2001	Liu et al.	439/131
D449,030	S	*	10/2001	Baxter et al.	D13/110
6,320,353	B1	*	11/2001	Chiu et al.	320/111
D454,537	S	*	3/2002	O'Connor et al.	D13/110
D456,008	S	*	4/2002	Kawanobe et al.	D13/110
D460,412	S	*	7/2002	Nawrozki	D13/107
6,638,113	B2	*	10/2003	Kajiwara et al.	439/651
6,669,495	B2	*	12/2003	Philips et al.	439/170
6,884,125	B2	*	4/2005	Chen	439/848
7,008,246	B2	*	3/2006	Zhuge	439/173
7,179,105	B1	*	2/2007	Hung	439/172
D543,147	S	*	5/2007	Ng	D13/138.1
D556,138	S	*	11/2007	Ng	D13/138.1

7,300,297	B1	*	11/2007	Wang	439/173
D562,766	S	*	2/2008	Yang	D13/110
D575,775	S	*	8/2008	Sekine	D14/242
D584,732	S	*	1/2009	Cho et al.	D14/434
D595,224	S	*	6/2009	Seil et al.	D13/110
7,547,219	B2	*	6/2009	Zhuge	439/173
D596,562	S	*	7/2009	Hong et al.	D13/110
D621,781	S	*	8/2010	Chang et al.	D13/137.2
7,794,251	B2	*	9/2010	Wen et al.	439/173
2003/0085686	A1	*	5/2003	Haga et al.	320/112

* cited by examiner

Primary Examiner — Rosemary K Tarcza

(74) *Attorney, Agent, or Firm* — Howard C. Miskin; Gloria Tsui-Yip

(57) **CLAIM**

I claim a switching power supply with changeable plugs, as shown and described.

DESCRIPTION

FIG. 1 is a side view of the switching power supply with changeable plugs showing my new design;
 FIG. 2 is a front view thereof;
 FIG. 3 is an opposite side view thereof;
 FIG. 4 is a bottom view thereof;
 FIG. 5 is a rear view thereof;
 FIG. 6 is a top view thereof;
 FIG. 7 is a perspective view thereof with an inserted changeable plug, the surface of said plug being unclaimed;
 FIG. 8 is a perspective view thereof without an inserted changeable plug;
 FIG. 9 is a perspective view of a changeable plug;
 FIG. 10 is a perspective view of a changeable plug;
 FIG. 11 is a perspective view of a changeable plug;
 FIG. 12 is a perspective view of a changeable plug; and,
 FIG. 13 is a perspective exploded view of a switching power supply with changeable plugs.

1 Claim, 5 Drawing Sheets

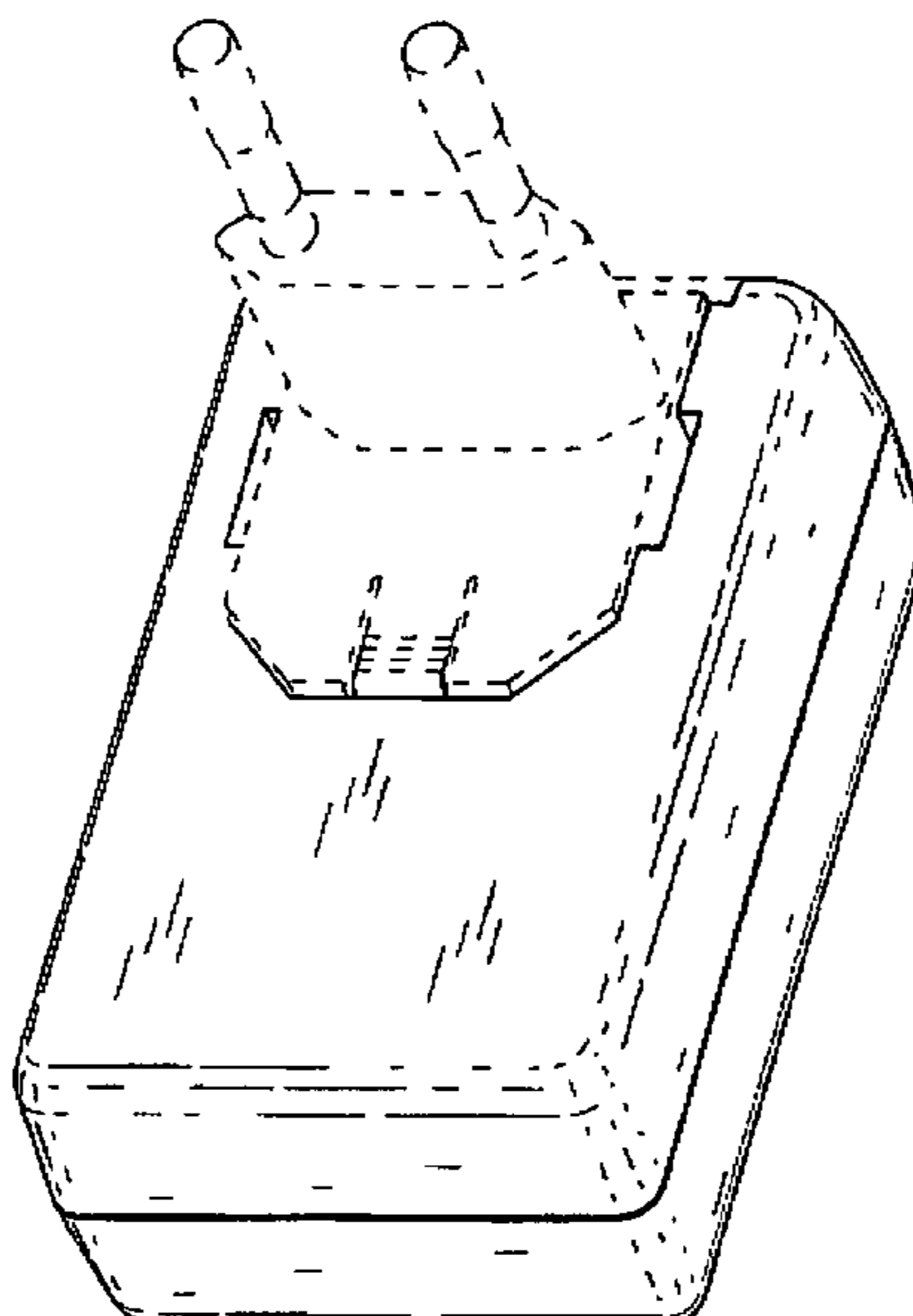

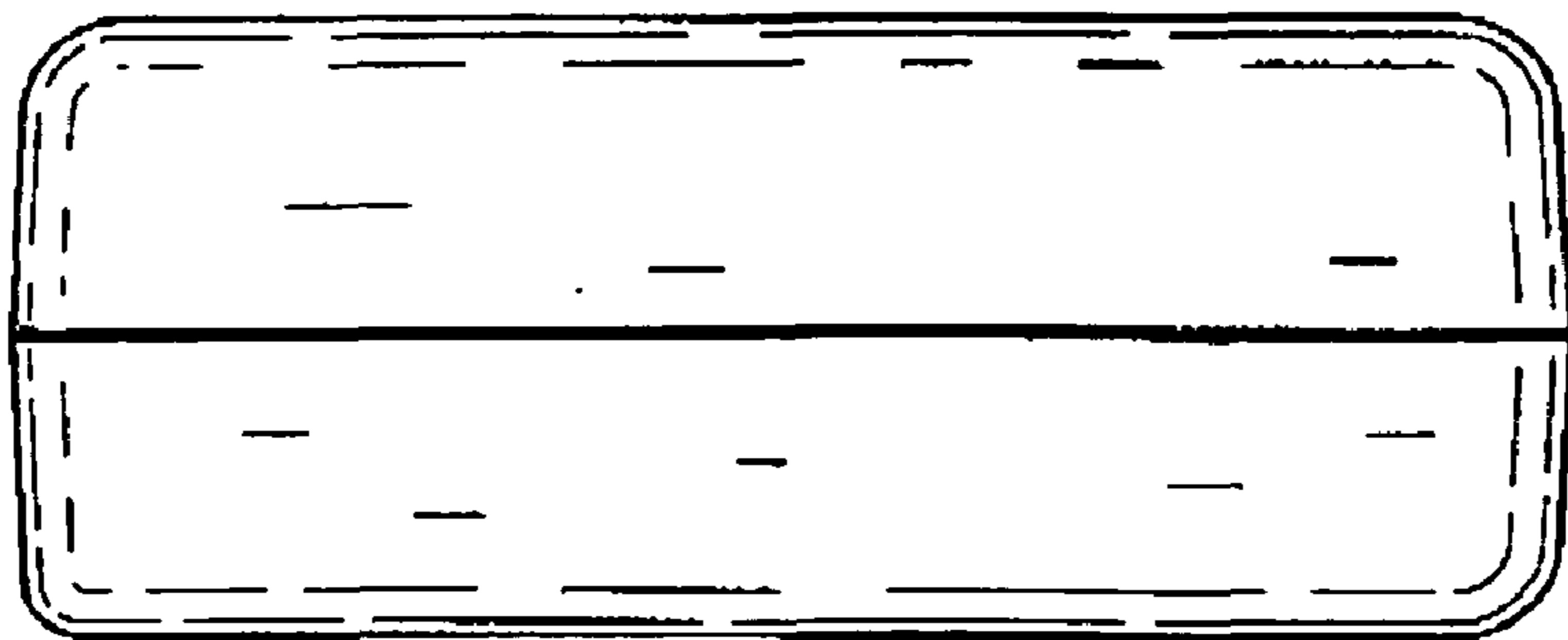

Fig.1

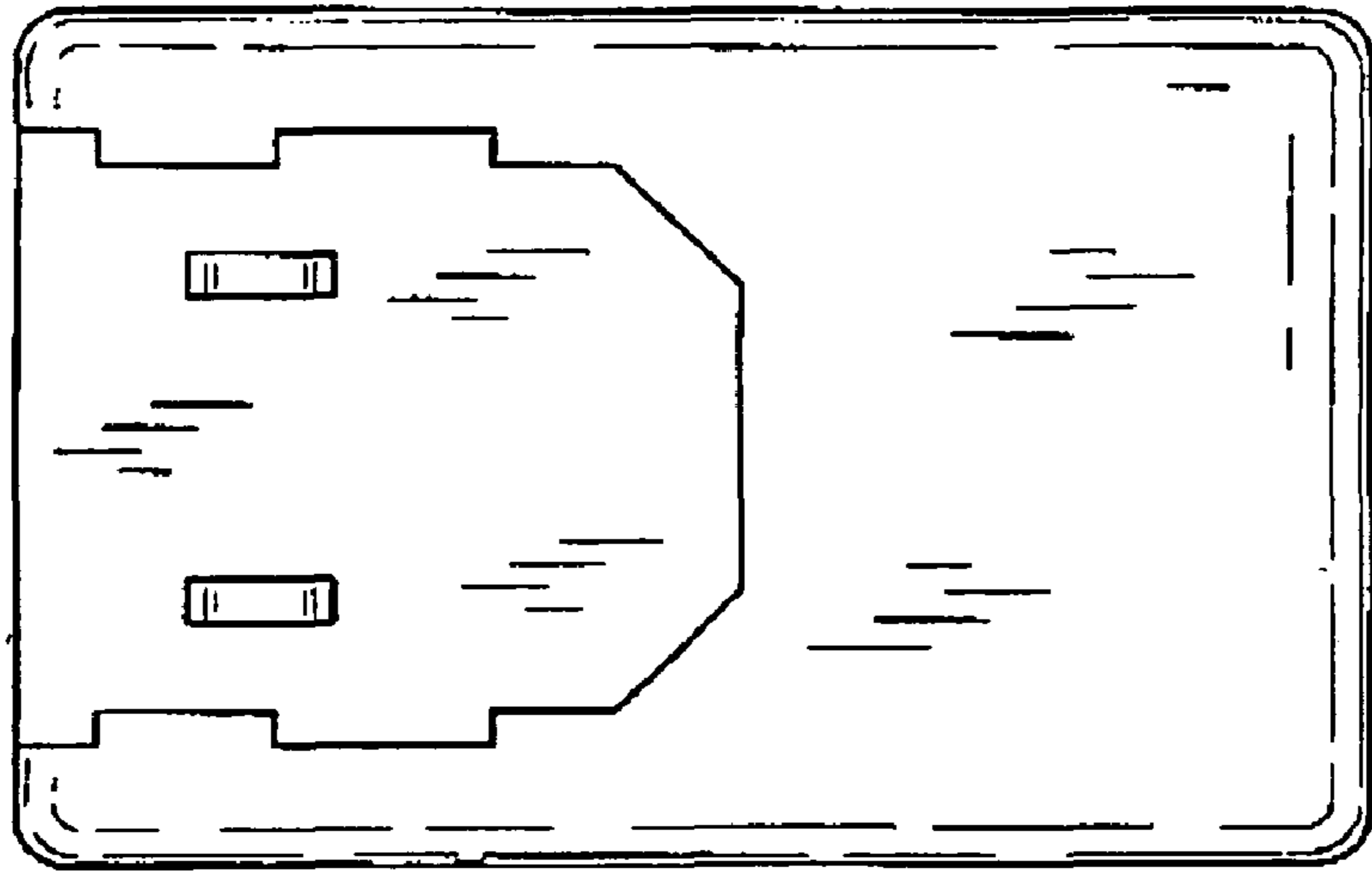

Fig.2

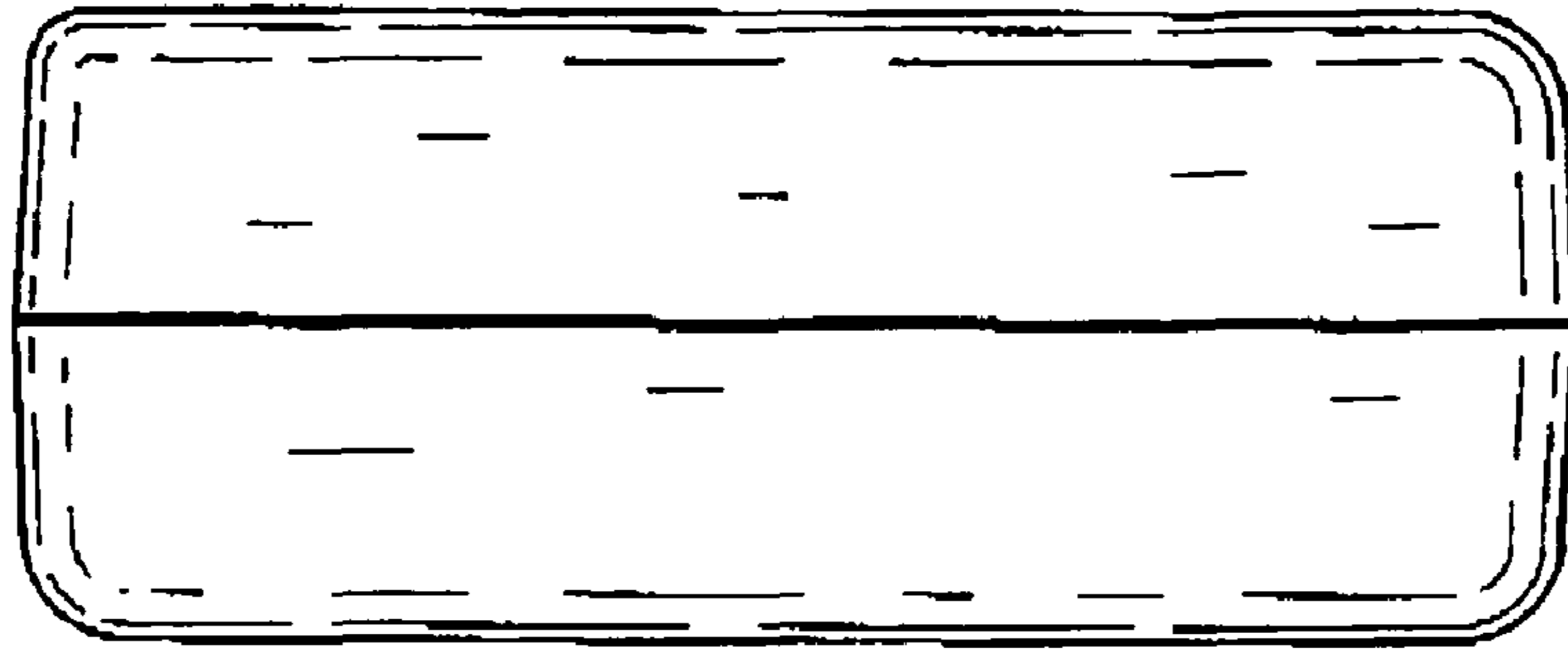

Fig.3

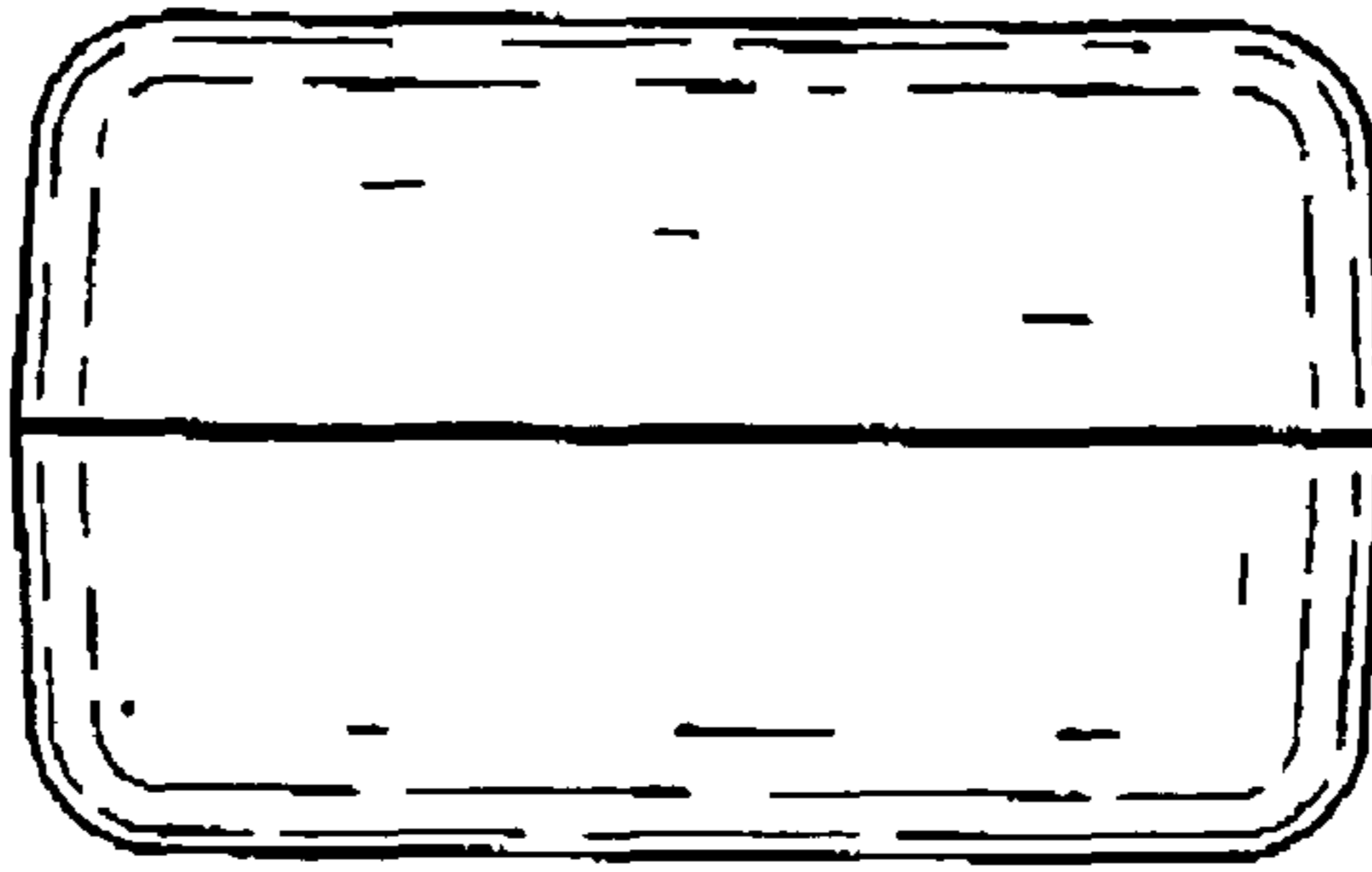

Fig.4

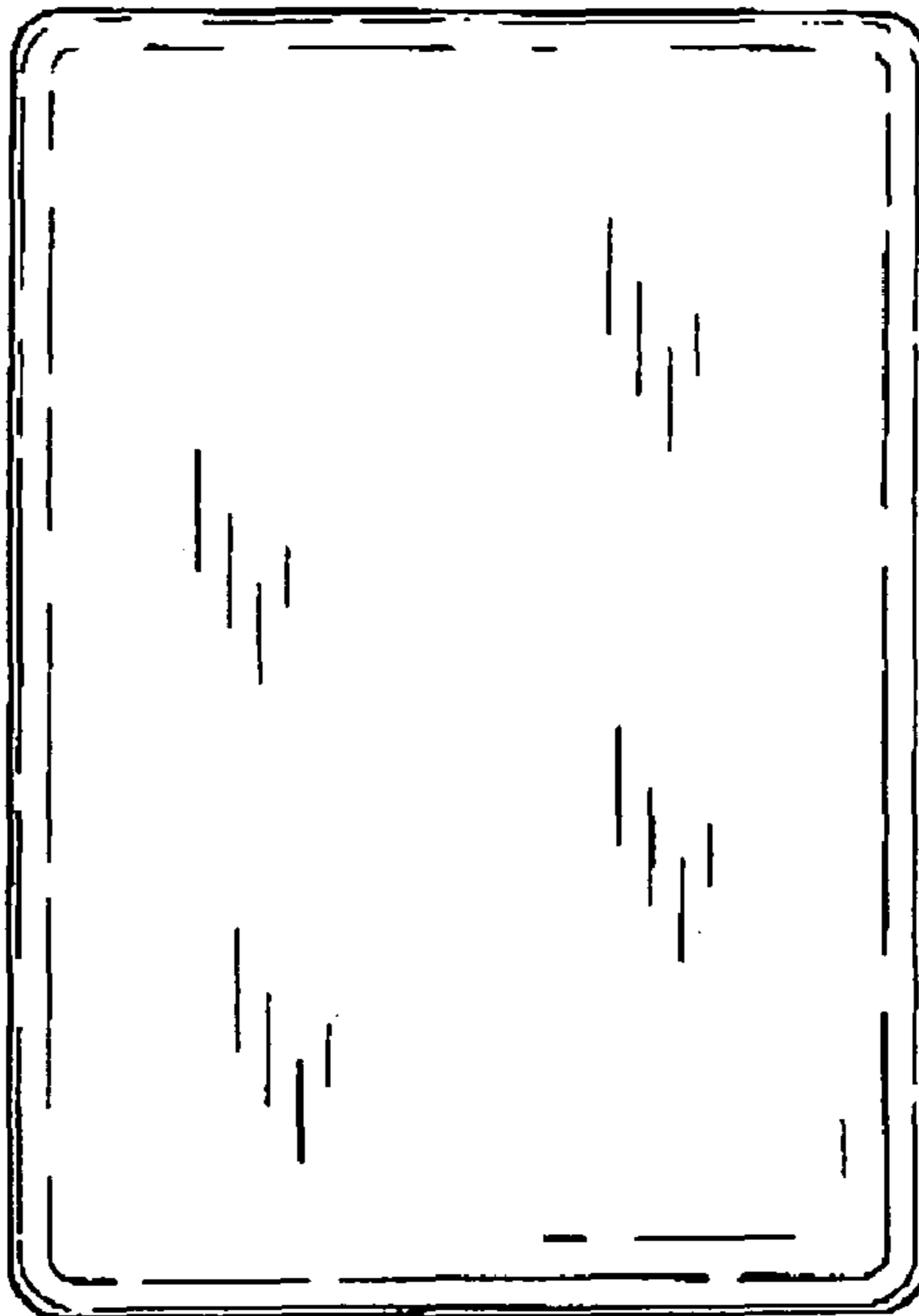

Fig.5

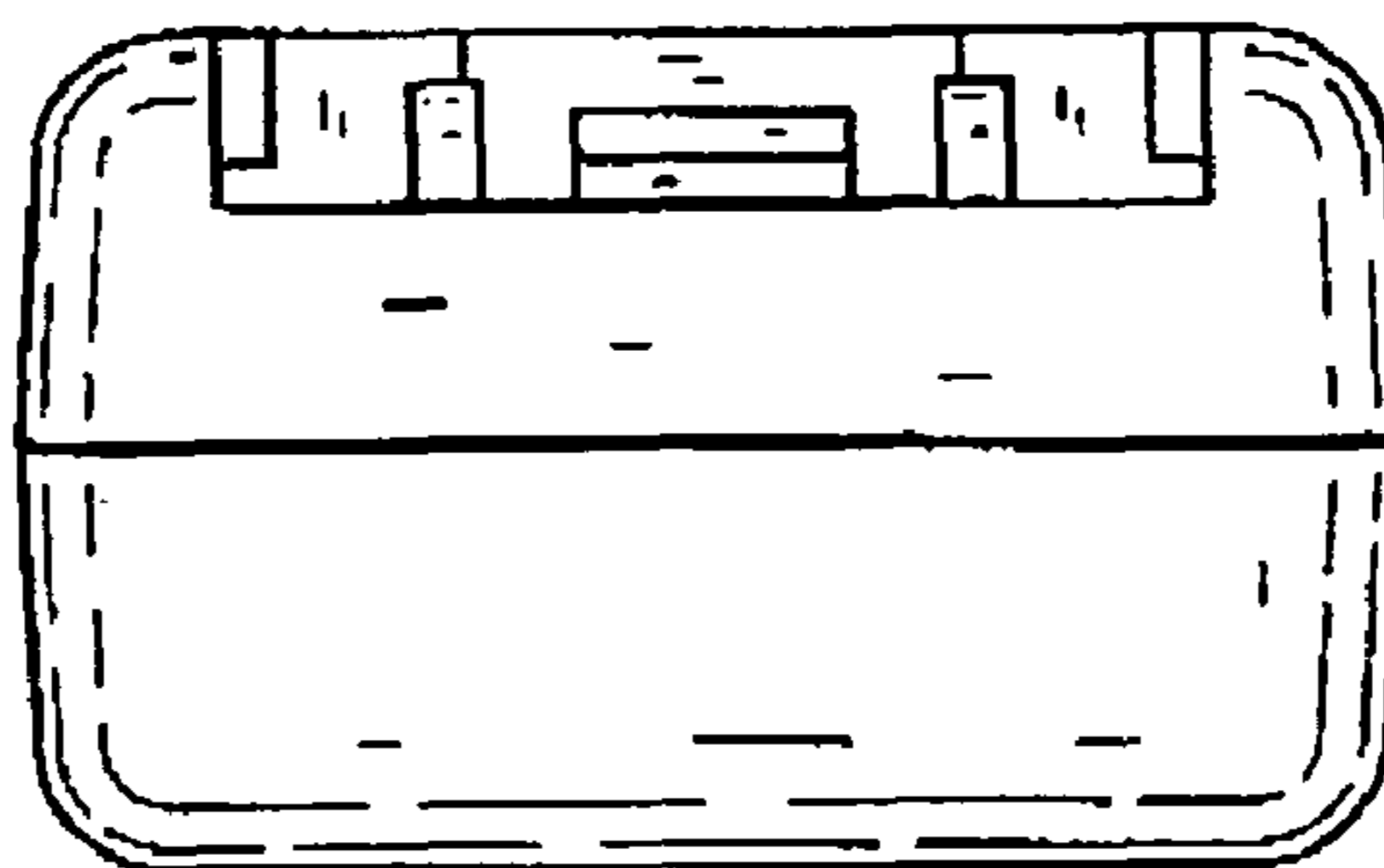

Fig.6

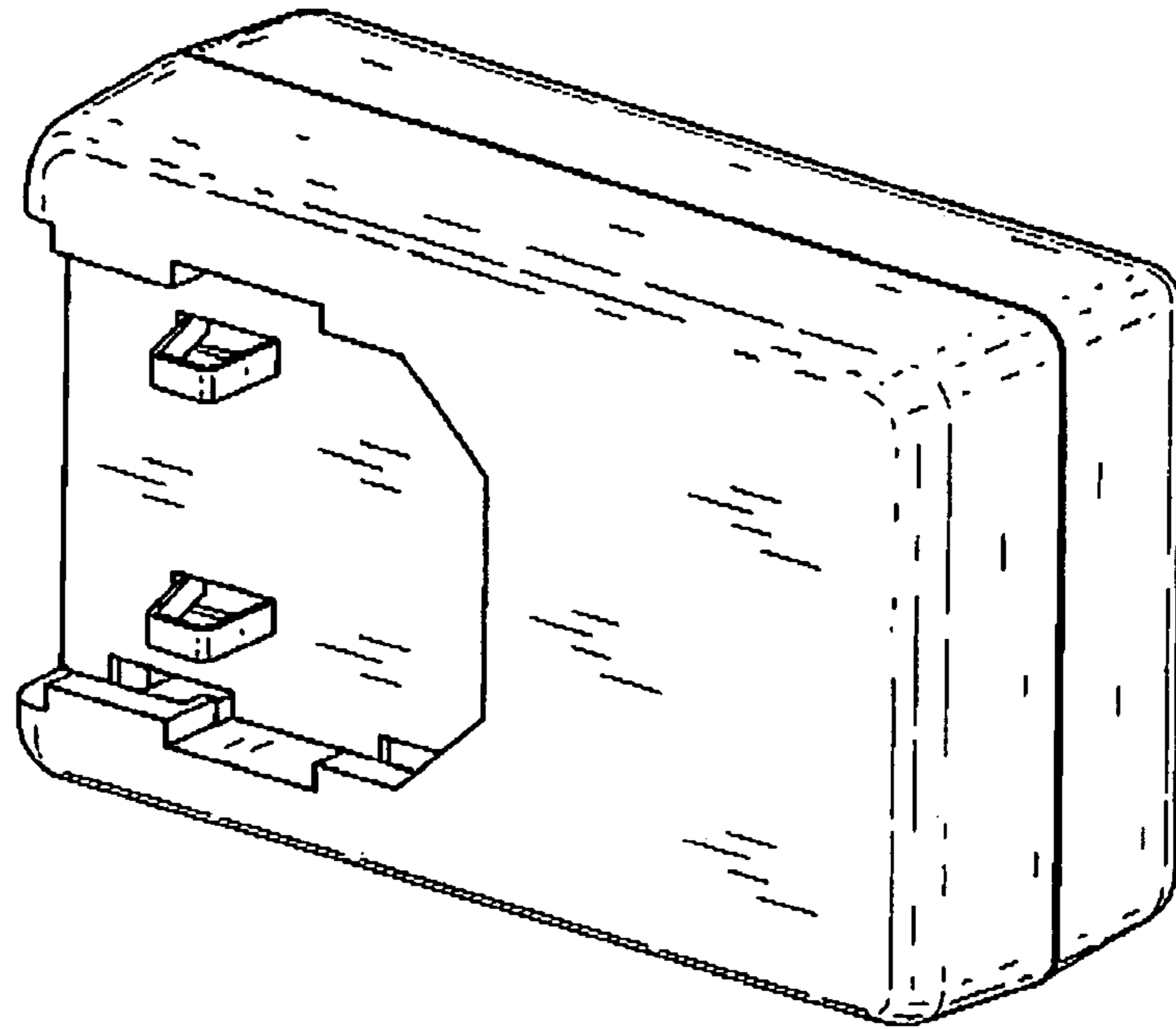

Fig.8

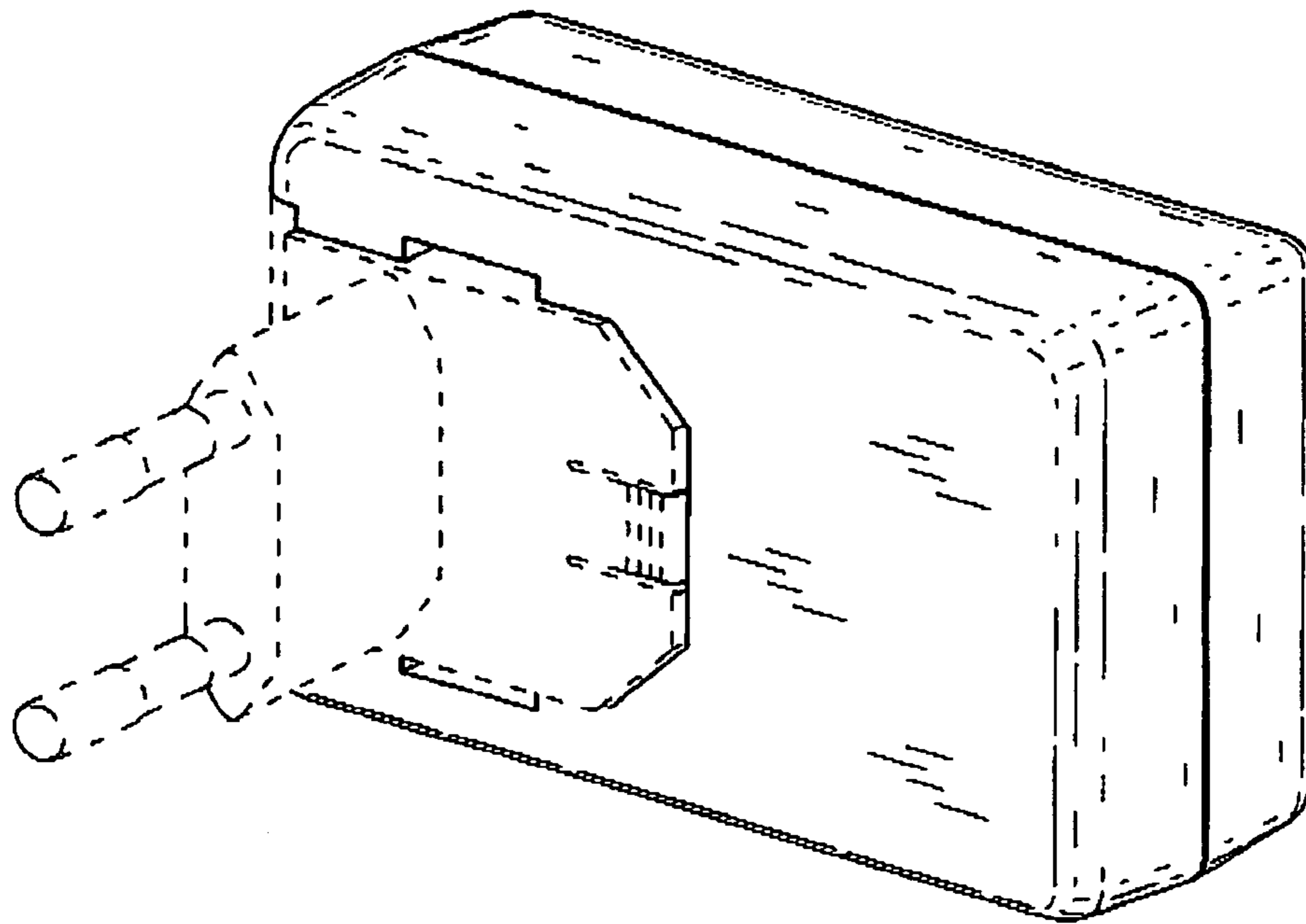

Fig.7

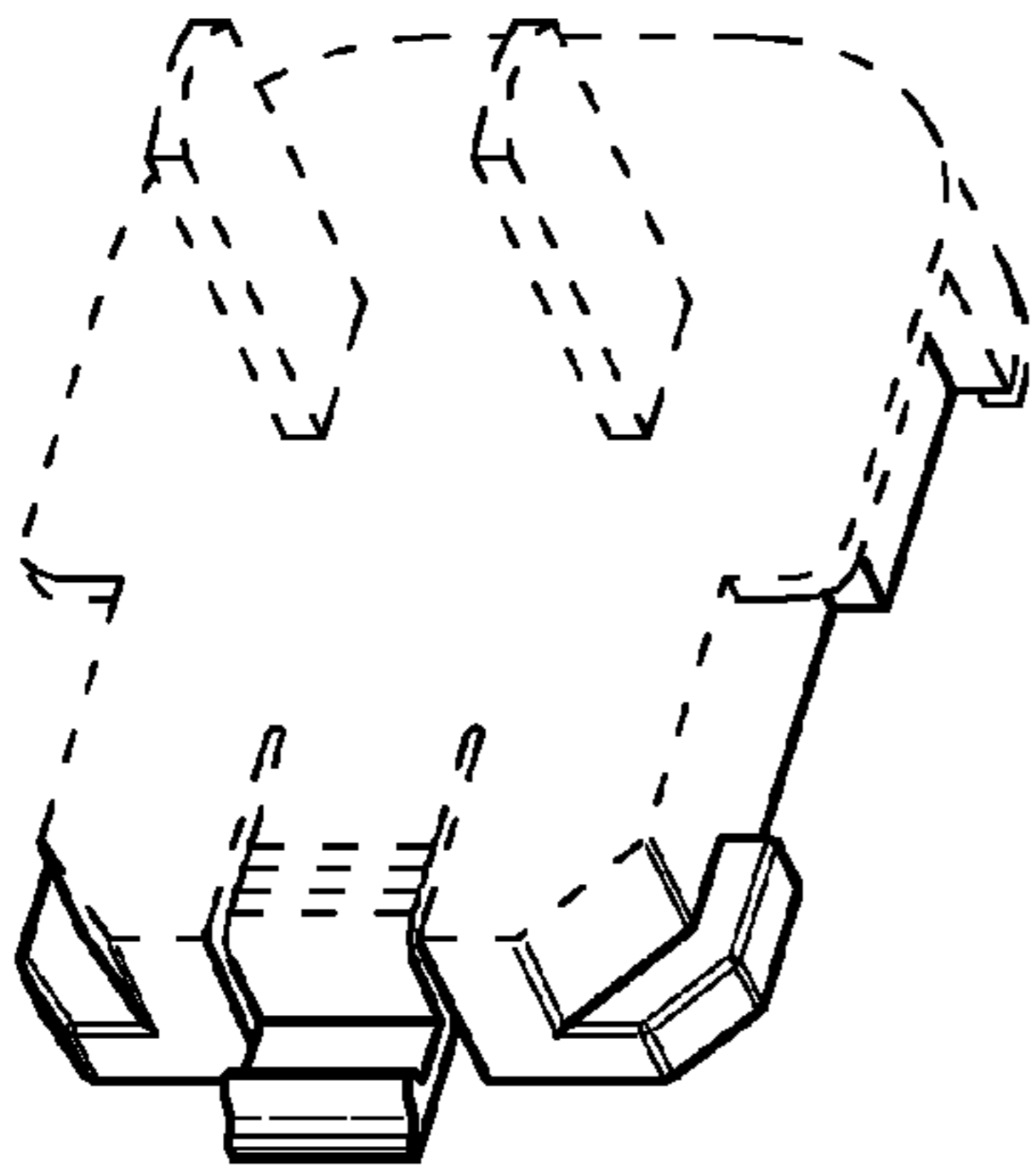

Fig.9

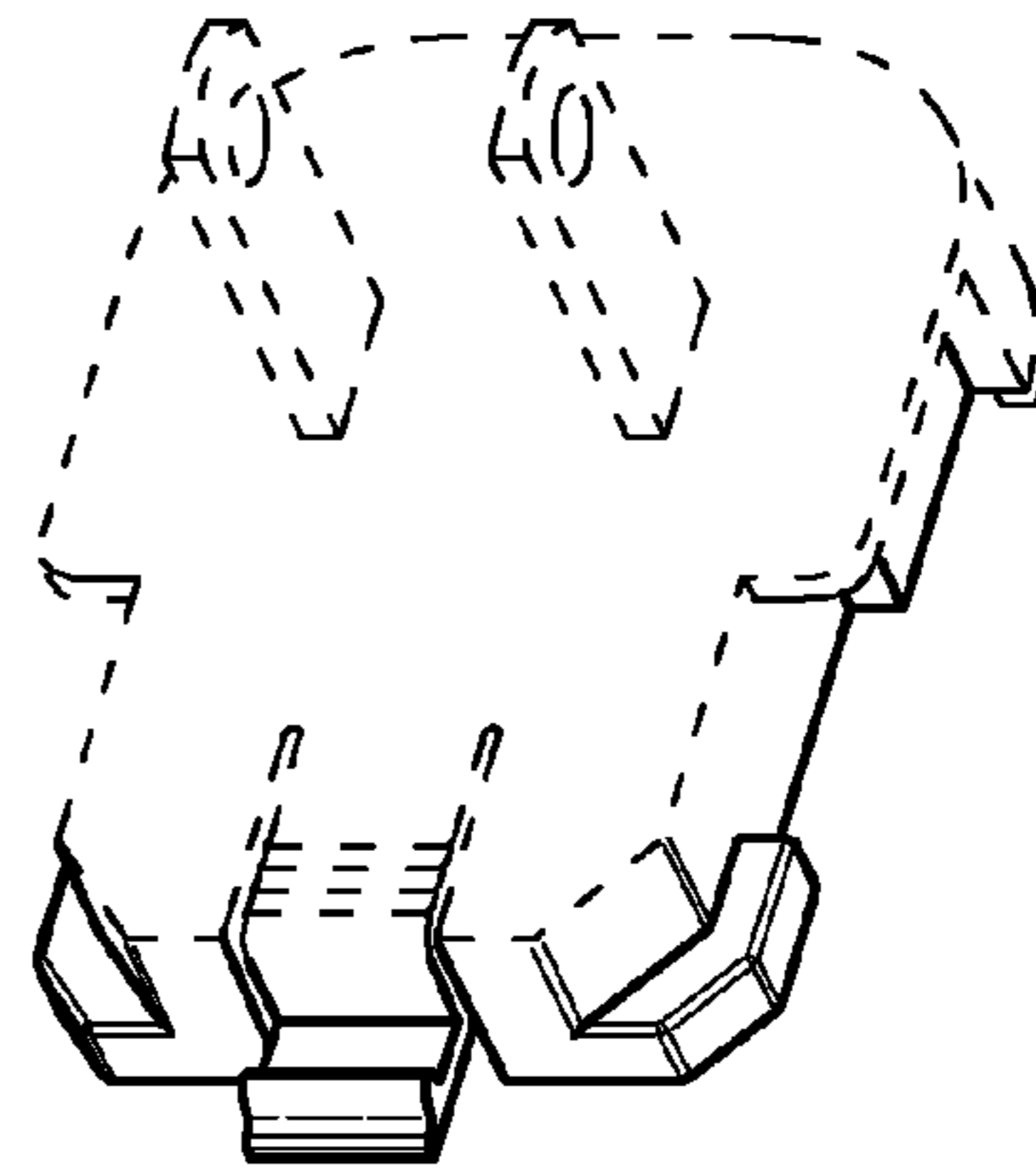

Fig.10

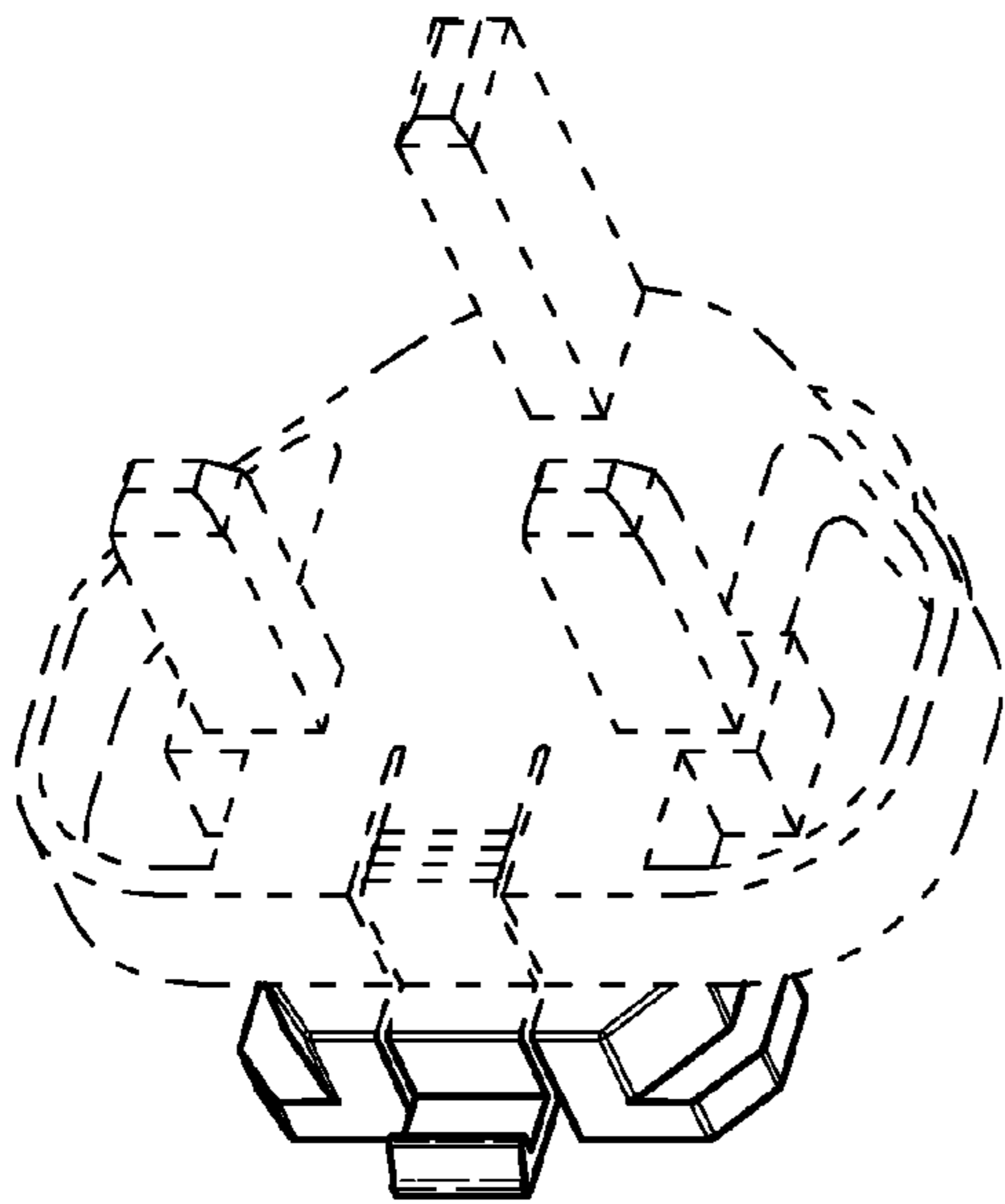

Fig.11

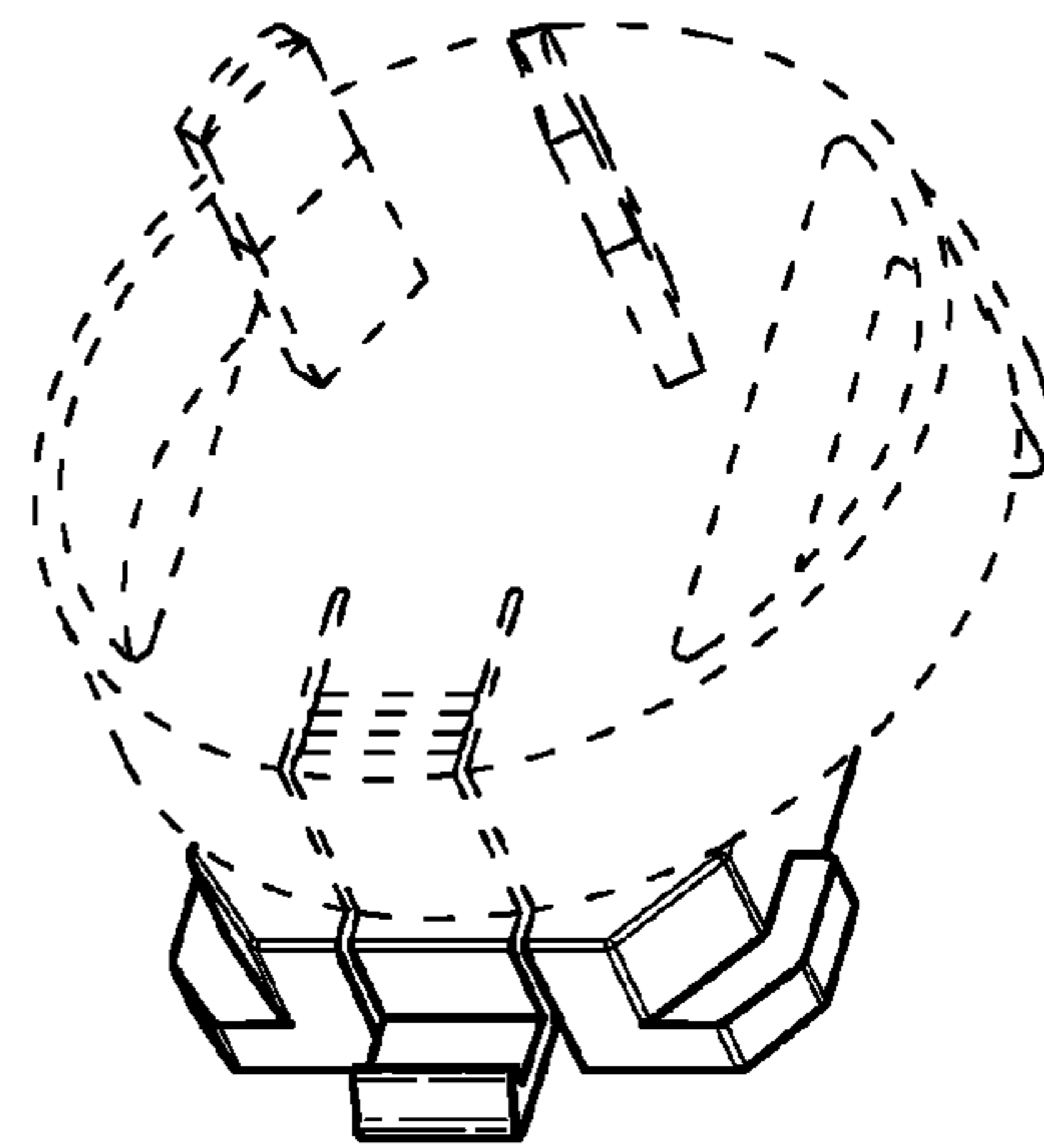

Fig.12

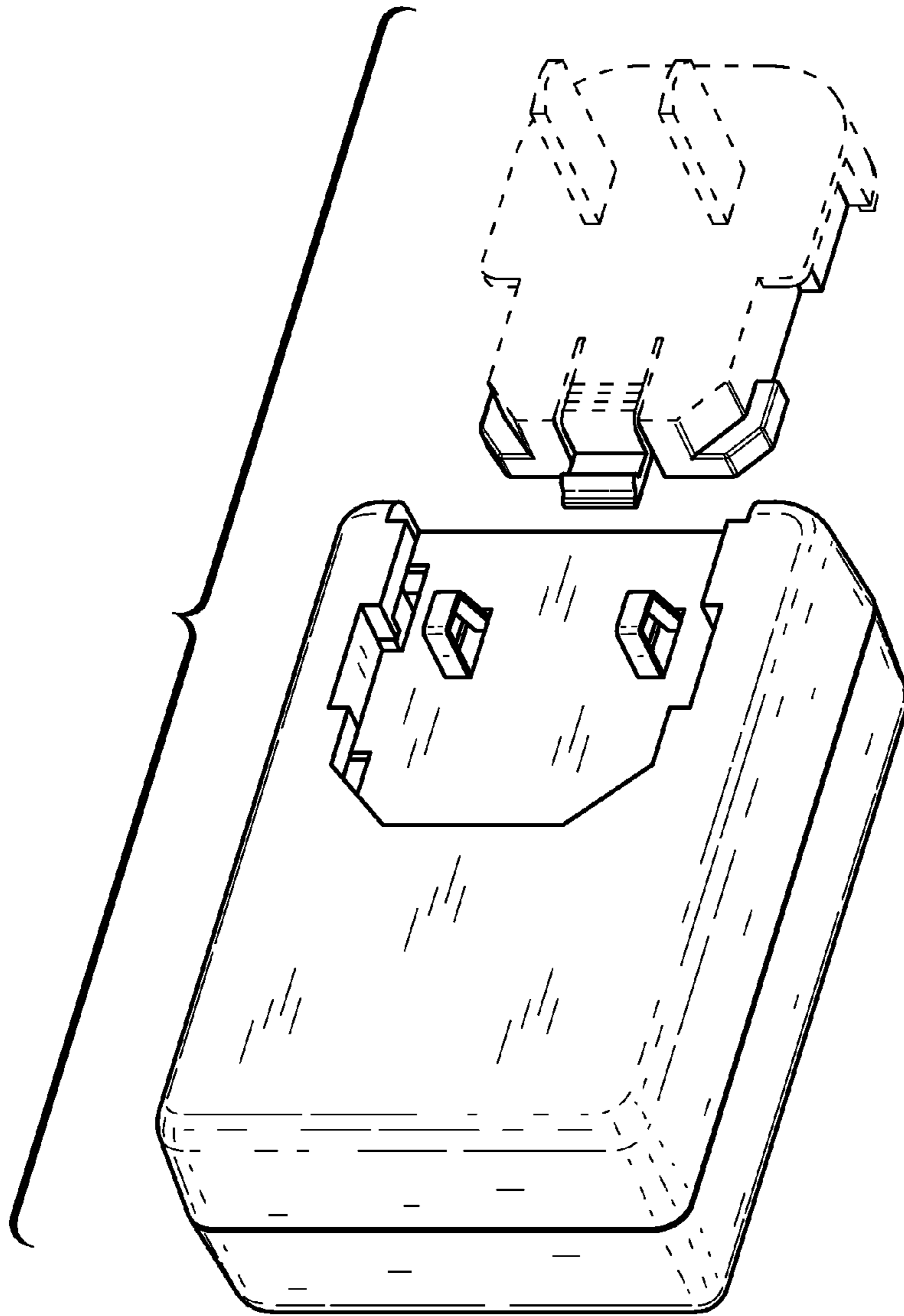

Fig.13