



US00D658098S

(12) **United States Design Patent**
Plainfield

(10) **Patent No.:** **US D658,098 S**

(45) **Date of Patent:** **** Apr. 24, 2012**

(54) **PAIR OF HANDLEBAR EXTENSION BARS**

(76) Inventor: **Richard Plainfield**, Portland, OR (US)

(**) Term: **14 Years**

(21) Appl. No.: **29/386,975**

(22) Filed: **Mar. 7, 2011**

(51) **LOC (9) Cl.** **12-11**

(52) **U.S. Cl.** **D12/178**

(58) **Field of Classification Search** D12/178,
D12/114, 110, 126; 180/219, 220; 74/551.1-551.9,
74/543, 544; 280/288.4, 274-280, 263, 281.1,
280/288.1-288.3, 270; D8/303; 16/110.1,
16/421

See application file for complete search history.

5,235,871 A	8/1993	Yamazaki et al.	
D340,432 S *	10/1993	Osborne	D12/114
5,265,496 A	11/1993	Townsend	
5,319,994 A	6/1994	Miller	
5,421,220 A	6/1995	Chen	
5,425,285 A	6/1995	Cheng	
5,429,013 A	7/1995	Taylor et al.	
5,511,444 A	4/1996	Clausen et al.	
D369,772 S	5/1996	Newkirk	
5,570,614 A *	11/1996	Nastrucci	74/551.1
D376,124 S *	12/1996	Bernloehr	D12/178
5,758,548 A	6/1998	Smith	
D397,069 S	8/1998	Newkirk	

(Continued)

OTHER PUBLICATIONS

J & P Cycles® Keeping the World on 2 Wheels® 2008 Sportbike parts and accessories catalog. Convertibars and Clip-on Handlebars on p. 109.*

(Continued)

(56) **References Cited**

U.S. PATENT DOCUMENTS

567,663 A	9/1896	Snyder
D26,340 S	11/1896	Murphy
583,105 A	5/1897	Wheeler
588,166 A	8/1897	McCoy
603,995 A	5/1898	Powell
689,217 A	12/1901	Palmer
3,481,218 A	12/1969	Yoshikawa
3,863,521 A	2/1975	Gatsos et al.
3,937,629 A	2/1976	Hamasaka
3,942,822 A	3/1976	Lewis
D263,293 S	3/1982	Janson
4,361,057 A	11/1982	Kochera
4,493,225 A	1/1985	Galahad
4,862,762 A	9/1989	Ross
5,024,119 A	6/1991	Linden
5,033,325 A	7/1991	Giard, Jr.
D323,805 S	2/1992	Giard, Jr.
5,138,893 A	8/1992	Copeland
5,138,900 A	8/1992	Hals
5,145,210 A	9/1992	Lennon
5,163,339 A	11/1992	Giard, Jr. et al.
5,195,394 A	3/1993	Latta
5,197,350 A	3/1993	Borromeo
5,201,243 A	4/1993	Schneider
5,224,396 A	7/1993	Lobbezoo et al.

Primary Examiner — Susan M Lee

Assistant Examiner — Linda G. Brooks

(74) *Attorney, Agent, or Firm* — Schwabe, Williamson & Wyatt, P.C.

(57) **CLAIM**

I claim an ornamental design for the pair of handlebar extension bars, as shown and described.

DESCRIPTION

FIG. 1 is a perspective view of the pair of handlebar extension bars, showing my new design; FIG. 2 is a front view thereof; FIG. 3 is a rear view thereof; FIG. 4 is a top view thereof; FIG. 5 is a bottom view thereof; and, FIG. 6 is a side view thereof. The dashed lines are included for illustrating environmental structure and form no part of the claimed design.

1 Claim, 3 Drawing Sheets

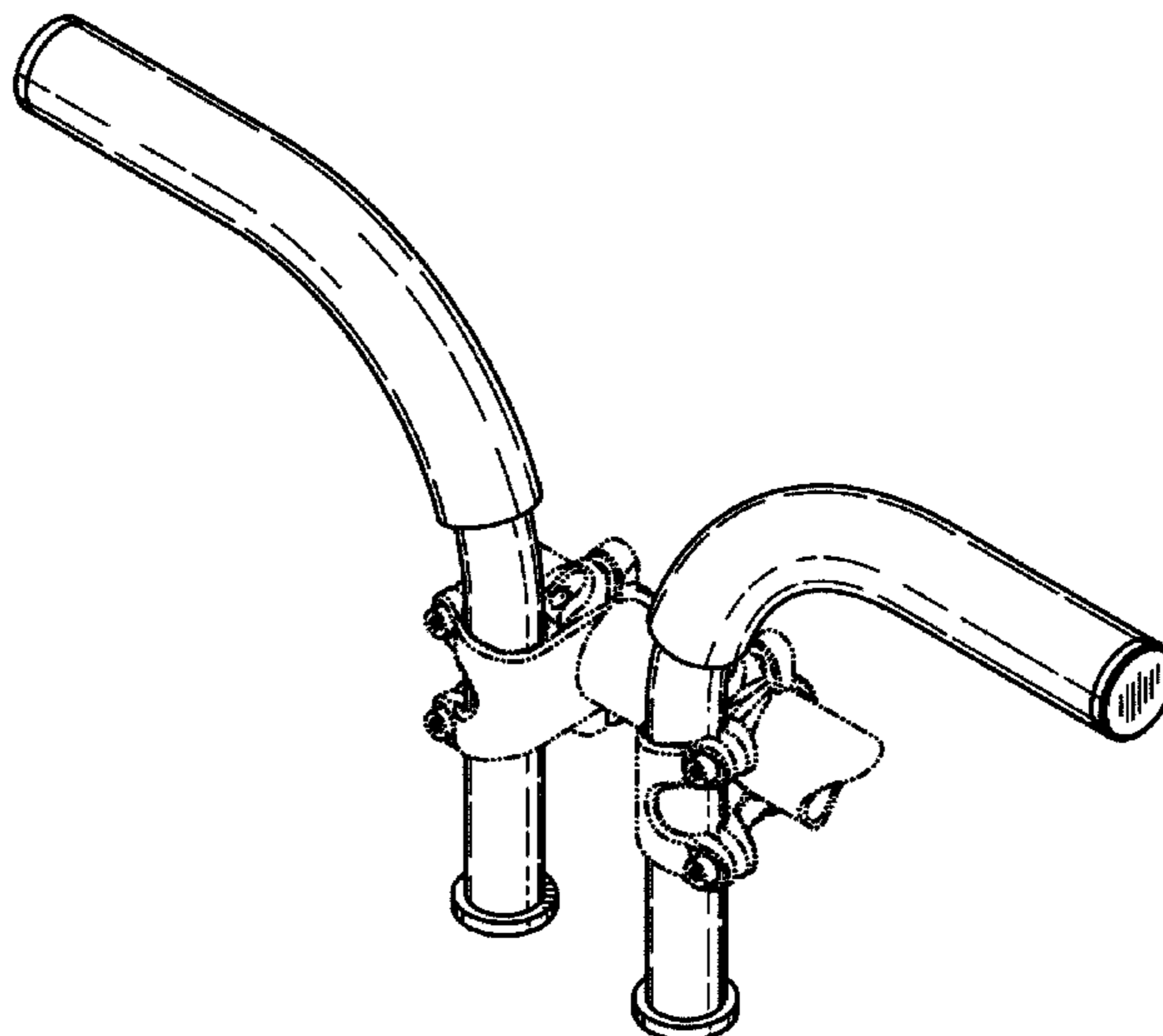

US D658,098 S

Page 2

U.S. PATENT DOCUMENTS

5,899,117 A 5/1999 Newkirk
5,983,747 A 11/1999 Chen
6,098,493 A 8/2000 Cortes
6,234,043 B1 5/2001 Marshall
6,564,673 B1 5/2003 Kilmer
D483,306 S 12/2003 Meinhold
6,662,680 B2 12/2003 Rocket
6,742,222 B2 * 6/2004 Furr-Britt et al. 16/430
6,811,174 B2 11/2004 Luetkemuller et al.
6,928,897 B2 * 8/2005 Duncan 74/551.8
7,077,029 B2 7/2006 McColligan et al.
7,127,966 B2 10/2006 Meng
7,207,237 B2 4/2007 Johnson
D557,643 S * 12/2007 Douglas D12/178

D572,181 S 7/2008 Lujan
D604,212 S 11/2009 Carlini
7,909,345 B1 * 3/2011 Olson 280/279
2003/0188601 A1 10/2003 Maslowsky et al.
2003/0229966 A1 12/2003 Boice
2004/0244526 A1 12/2004 Jones
2005/0246861 A1 11/2005 Monrad
2008/0202281 A1 8/2008 Bruyere

OTHER PUBLICATIONS

Photograph of experimental prototype used to test functionality of device, dated Feb. 24, 2010.

* cited by examiner

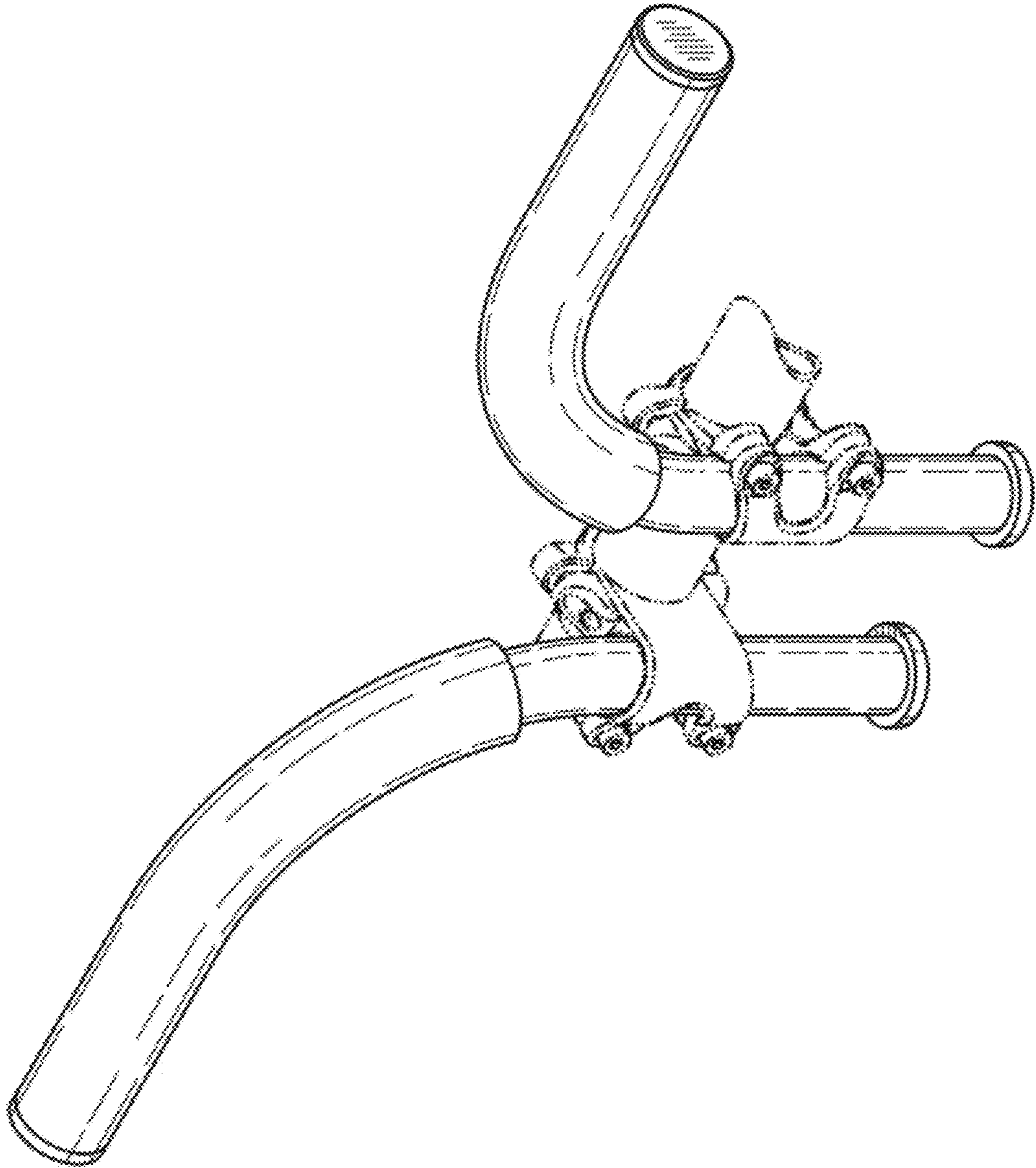

FIG. 1

Fig. 2

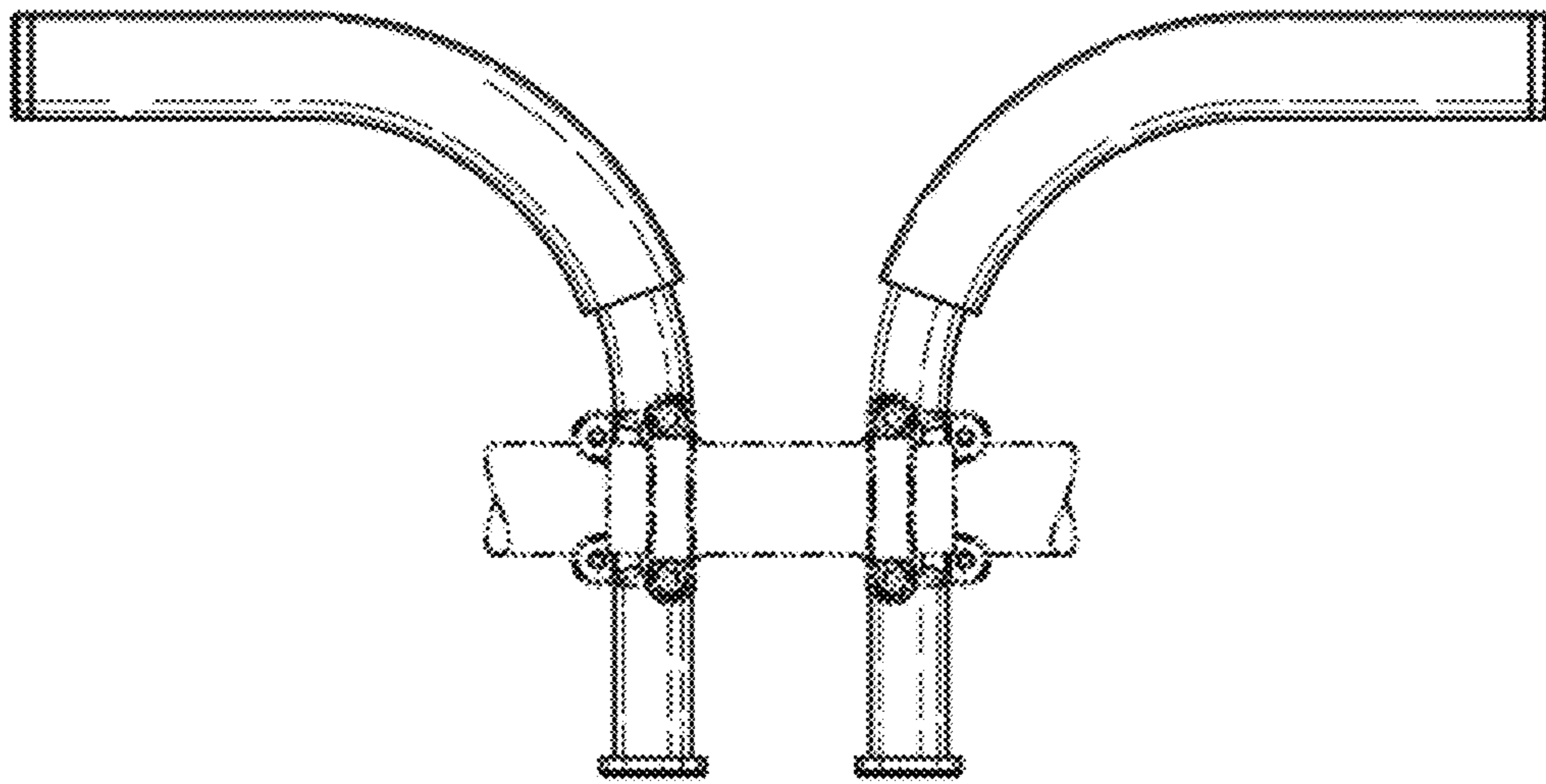

Fig. 3

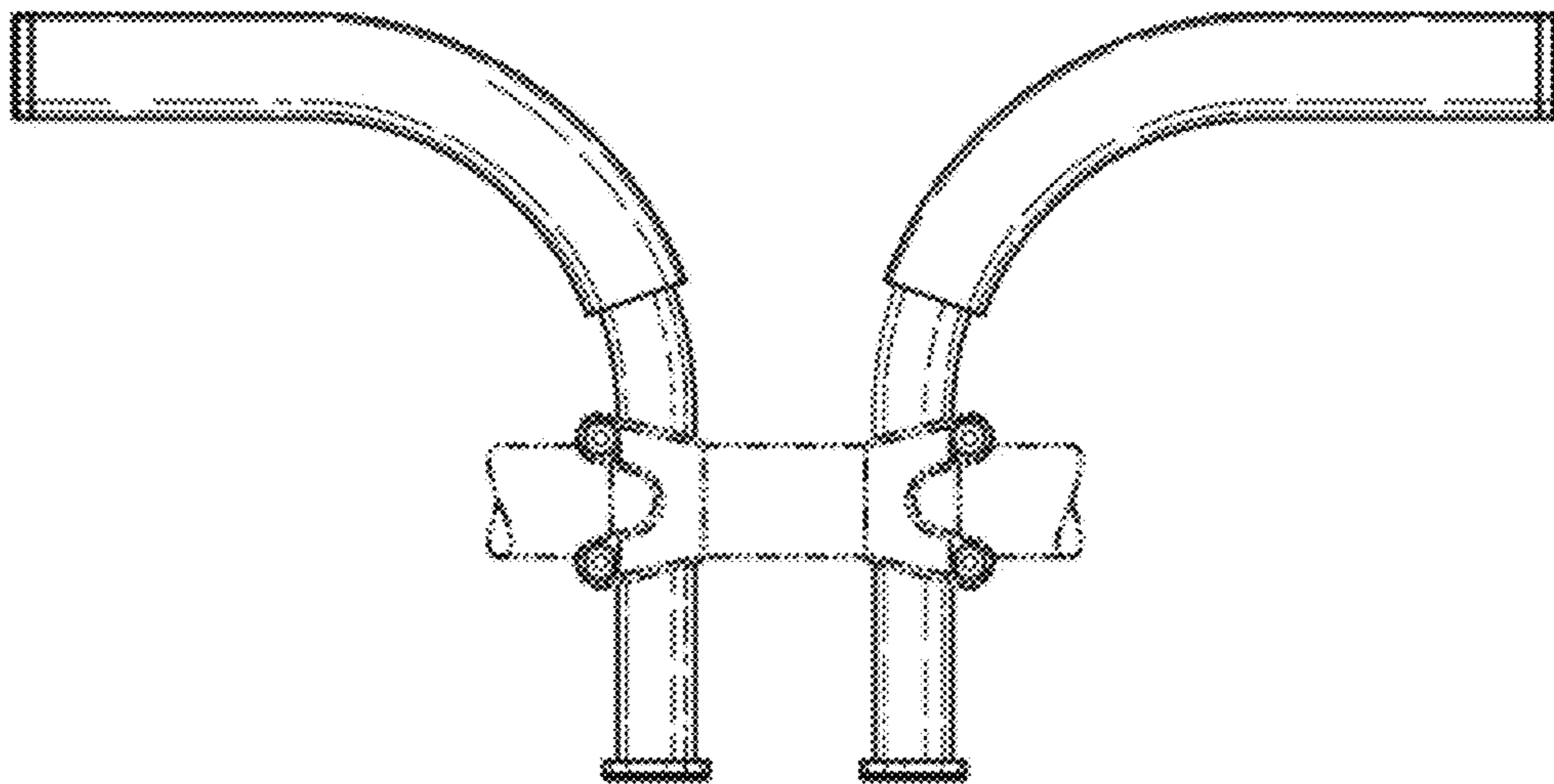

Fig. 4

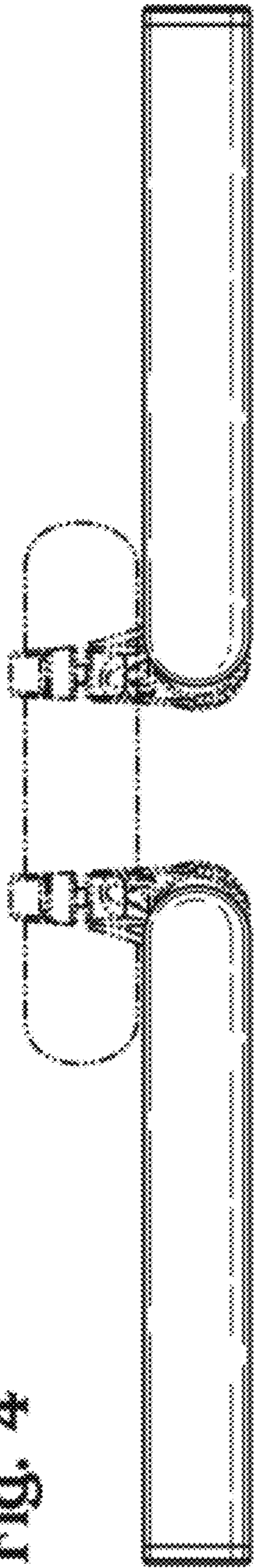

Fig. 5

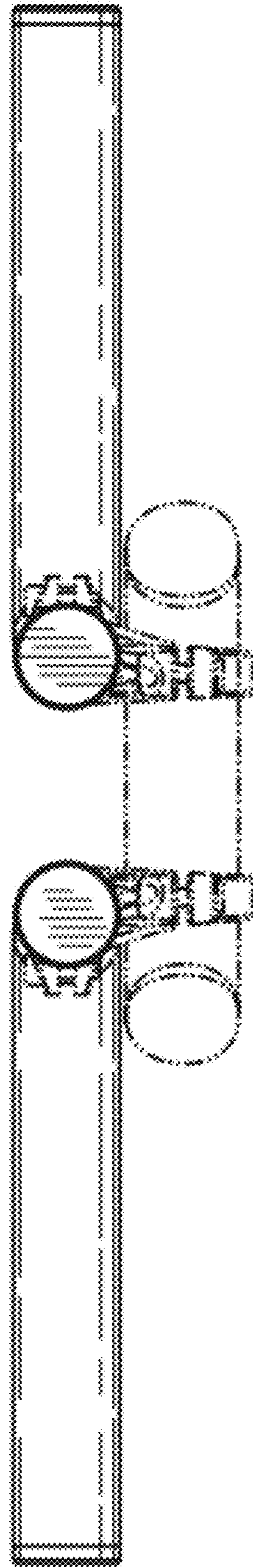
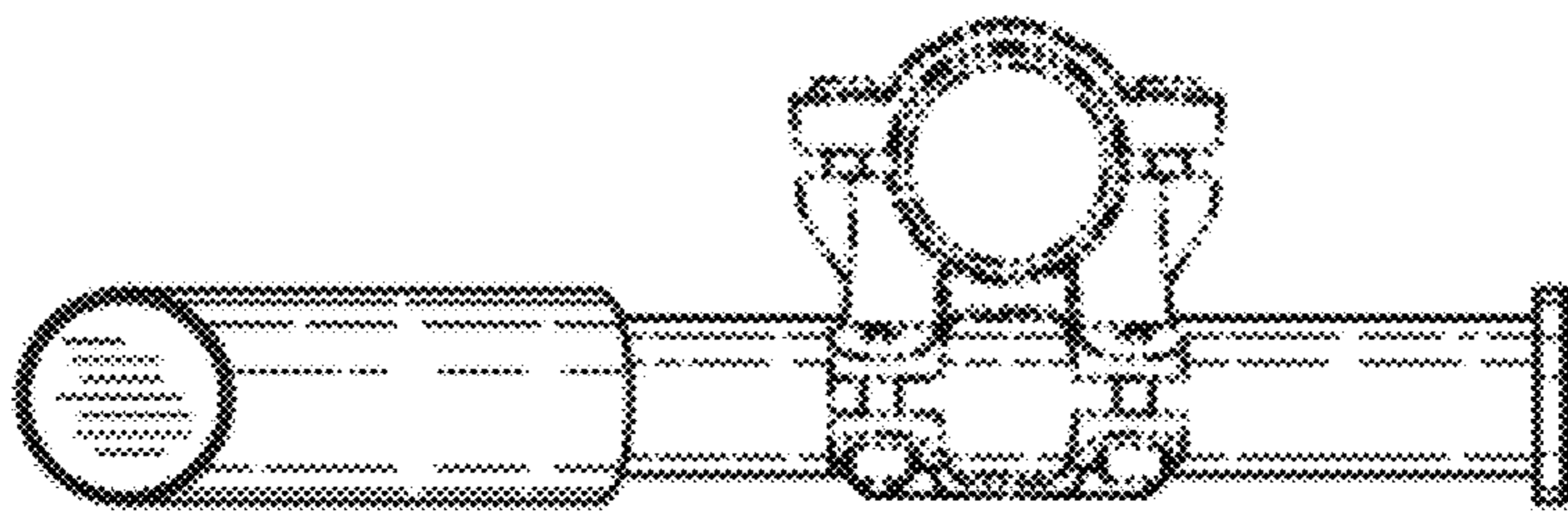

Fig. 6



UNITED STATES PATENT AND TRADEMARK OFFICE
CERTIFICATE OF CORRECTION

PATENT NO. : D658,098 S
APPLICATION NO. : 29/386975
DATED : April 24, 2012
INVENTOR(S) : Richard Plainfield

Page 1 of 5

It is certified that error appears in the above-identified patent and that said Letters Patent is hereby corrected as shown below:

Delete Title Page, and replace with new Title Page. (Attached)

In the drawings:

All drawing sheets are replaced with the attached originally-filed drawings, which clearly show the claimed and unclaimed portions.

Signed and Sealed this
Sixteenth Day of October, 2012

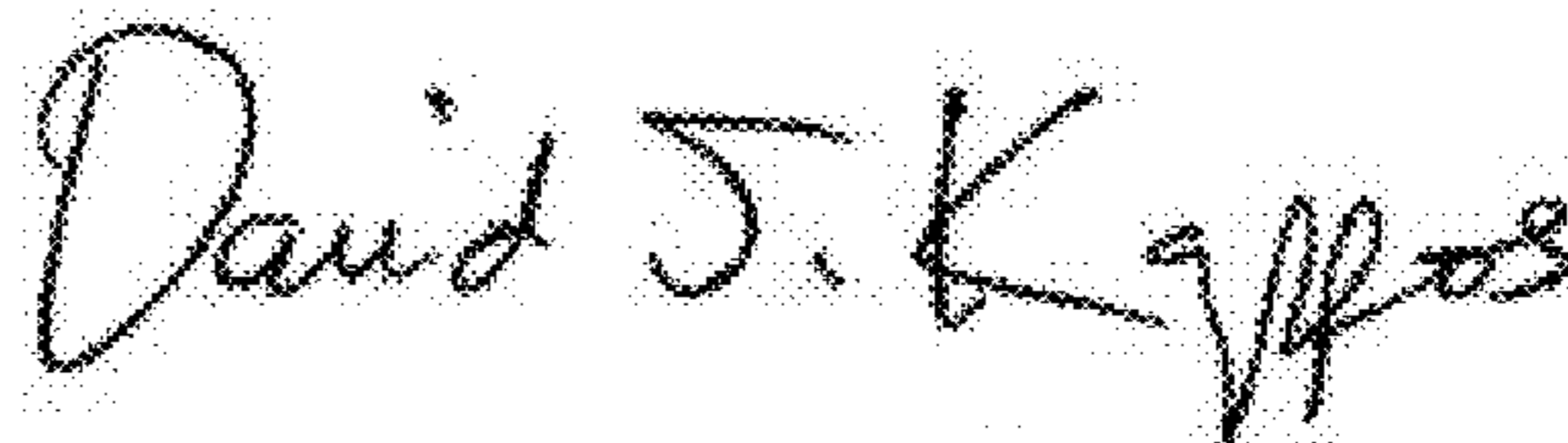
A handwritten signature in black ink that reads "David J. Kappos". The signature is written in a cursive style with a large, stylized 'D' and 'K'.

David J. Kappos
Director of the United States Patent and Trademark Office

(12) **United States Design Patent**
Plainfield

(10) **Patent No.:** **US D658,098 S**
(45) **Date of Patent:** **** Apr. 24, 2012**

(54) **PAIR OF HANDLEBAR EXTENSION BARS**
(76) Inventor: **Richard Plainfield**, Portland, OR (US)
(**) Term: **14 Years**
(21) Appl. No.: **29/386,975**
(22) Filed: **Mar. 7, 2011**
(51) **LOC (9) Cl.** **12-11**
(52) **U.S. Cl.** **D12/178**
(58) **Field of Classification Search** D12/178,
D12/114, 110, 126; 180/219, 220; 74/551.1-551.9,
74/543, 544; 280/288.4, 274-280, 263, 281.1,
280/288.1-288.3, 270; D8/303; 16/110.1,
16/421
See application file for complete search history.

5,235,871 A 8/1993 Yamazaki et al.
D340,432 S * 10/1993 Osborne D12/114
5,265,496 A 11/1993 Townsend
5,319,994 A 6/1994 Miller
5,421,220 A 6/1995 Chen
5,425,285 A 6/1995 Cheng
5,429,013 A 7/1995 Taylor et al.
5,511,444 A 4/1996 Clausen et al.
D369,772 S 5/1996 Newkirk
5,570,614 A * 11/1996 Nastrucci 74:551.1
D376,124 S * 12/1996 Bernloehr D12/178
5,758,548 A 6/1998 Smith
D397,069 S 8/1998 Newkirk

(Continued)

OTHER PUBLICATIONS

J & P Cycles® Keeping the World on 2 Wheels® 2008 Sportbike parts and accessories catalog. Convertibars and Clip-on Handlebars on p. 109.*

(Continued)

(56) **References Cited**

U.S. PATENT DOCUMENTS

567,663 A 9/1896 Snyder
D26,340 S 11/1896 Murphy
583,105 A 5/1897 Wheeler
588,166 A 8/1897 McCoy
603,995 A 5/1898 Powell
689,217 A 12/1901 Palmer
3,481,218 A 12/1969 Yoshikawa
3,863,521 A 2/1975 Gatsos et al.
3,937,629 A 2/1976 Hamasaka
3,942,822 A 3/1976 Lewis
D263,293 S 3/1982 Janson
4,361,057 A 11/1982 Kochera
4,493,225 A 1/1985 Galahad
4,862,762 A 9/1989 Ross
5,024,119 A 6/1991 Linden
5,033,325 A 7/1991 Giard, Jr.
D323,805 S 2/1992 Giard, Jr.
5,138,893 A 8/1992 Copeland
5,138,900 A 8/1992 Hals
5,145,210 A 9/1992 Lennon
5,163,339 A 11/1992 Giard, Jr. et al.
5,195,394 A 3/1993 Latta
5,197,350 A 3/1993 Borromeo
5,201,243 A 4/1993 Schneider
5,224,396 A 7/1993 Lobstero et al.

Primary Examiner — Susan M Lee
Assistant Examiner — Linda G. Brooks
(74) *Attorney, Agent, or Firm* — Schwabe, Williamson & Wyatt, P.C.

(57) **CLAIM**
I claim an ornamental design for the pair of handlebar extension bars, as shown and described.

DESCRIPTION

FIG. 1 is a perspective view of the pair of handlebar extension bars, showing my new design;
FIG. 2 is a front view thereof;
FIG. 3 is a rear view thereof;
FIG. 4 is a top view thereof;
FIG. 5 is a bottom view thereof; and,
FIG. 6 is a side view thereof.
The dashed lines are included for illustrating environmental structure and form no part of the claimed design.

1 Claim, 3 Drawing Sheets

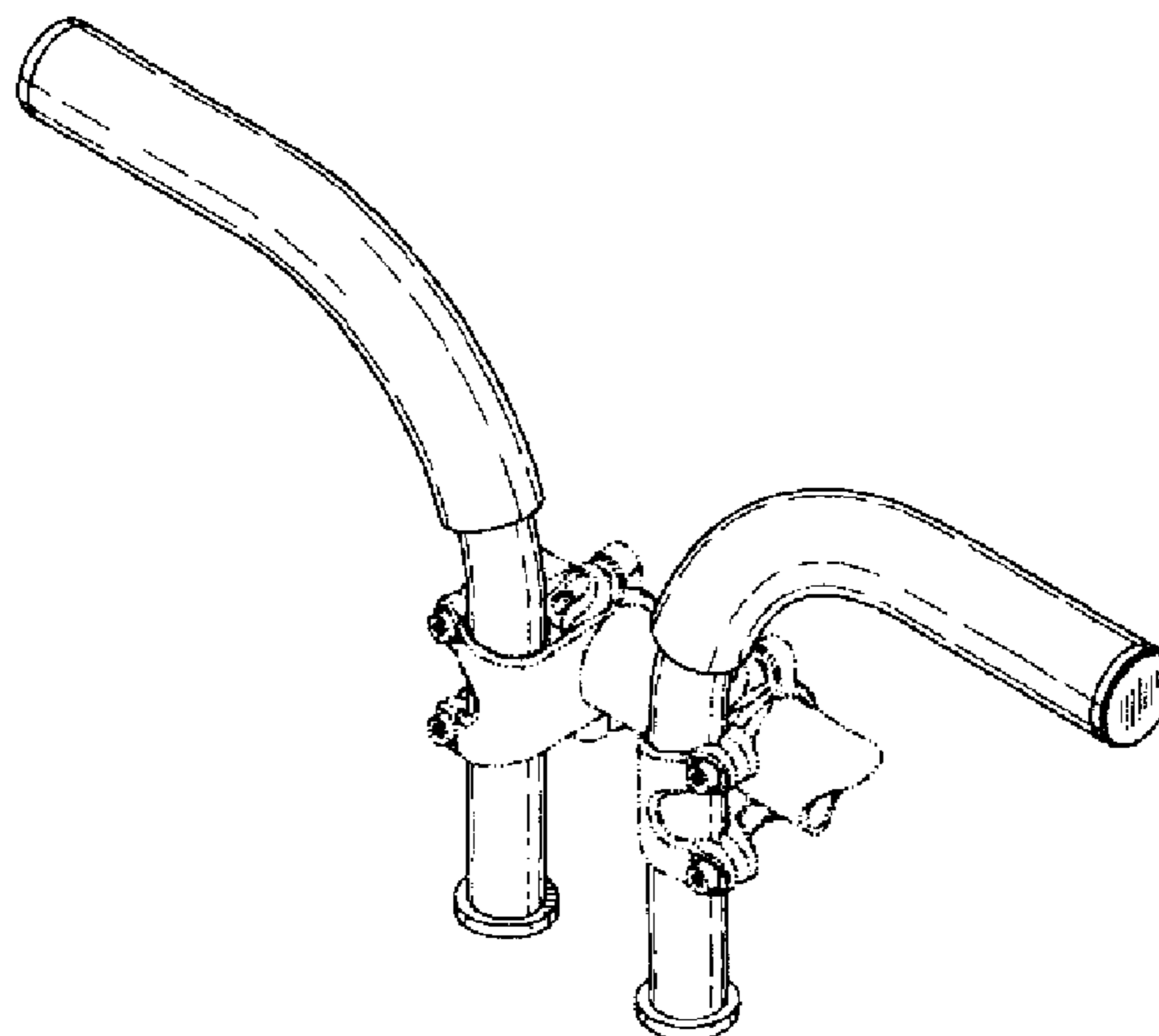

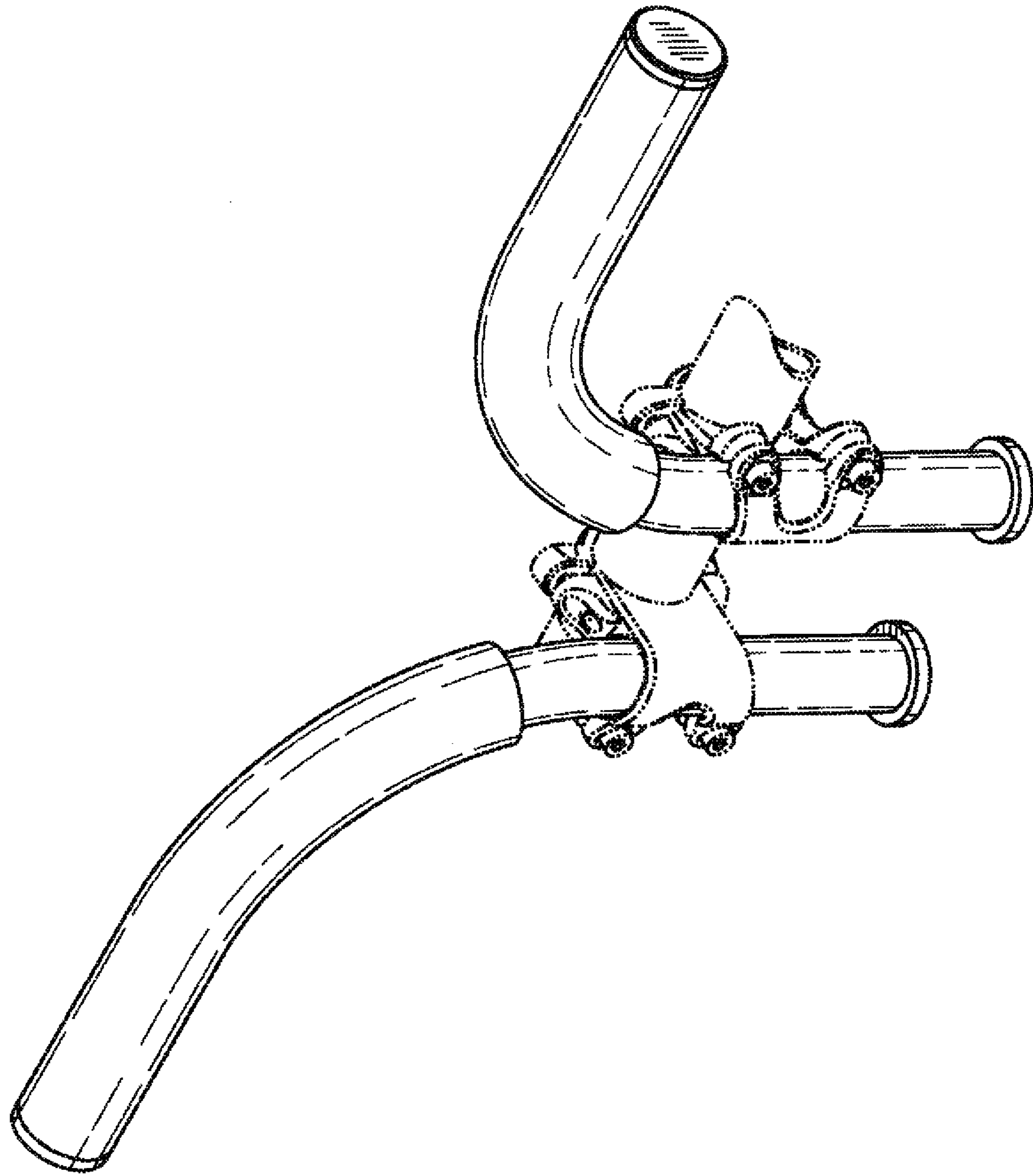

Fig. 1

Fig. 2

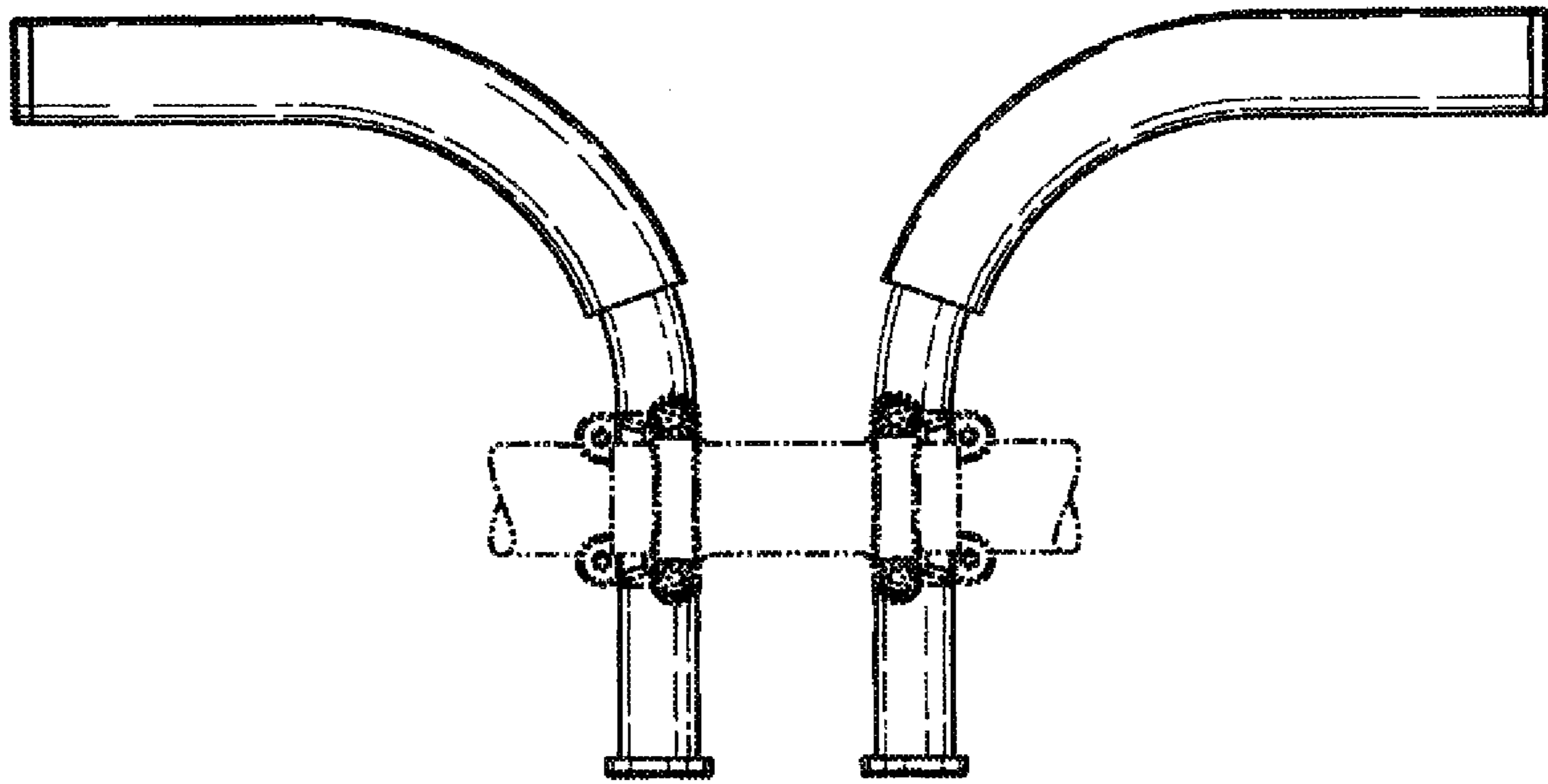

Fig. 3

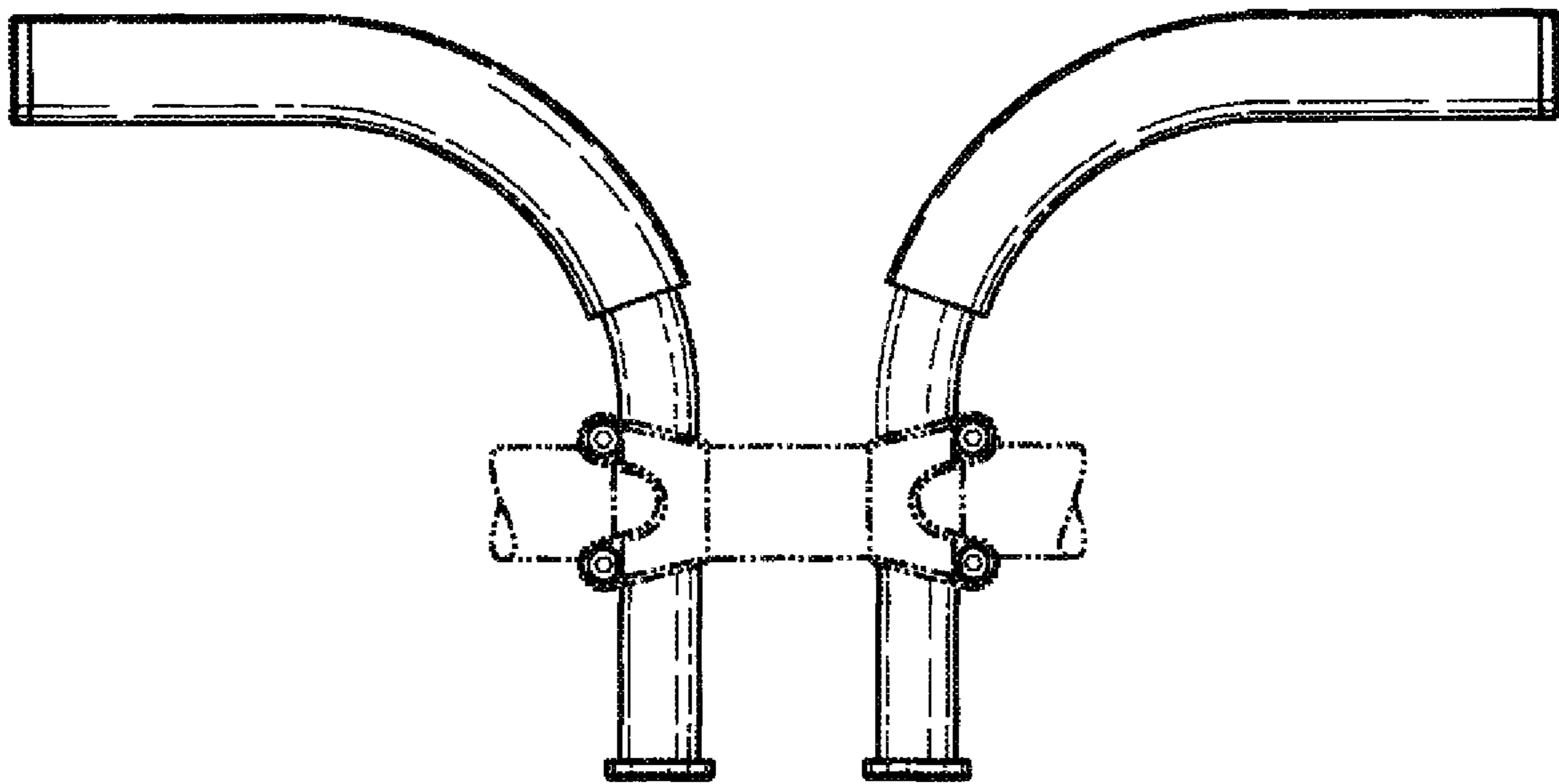

Fig. 6

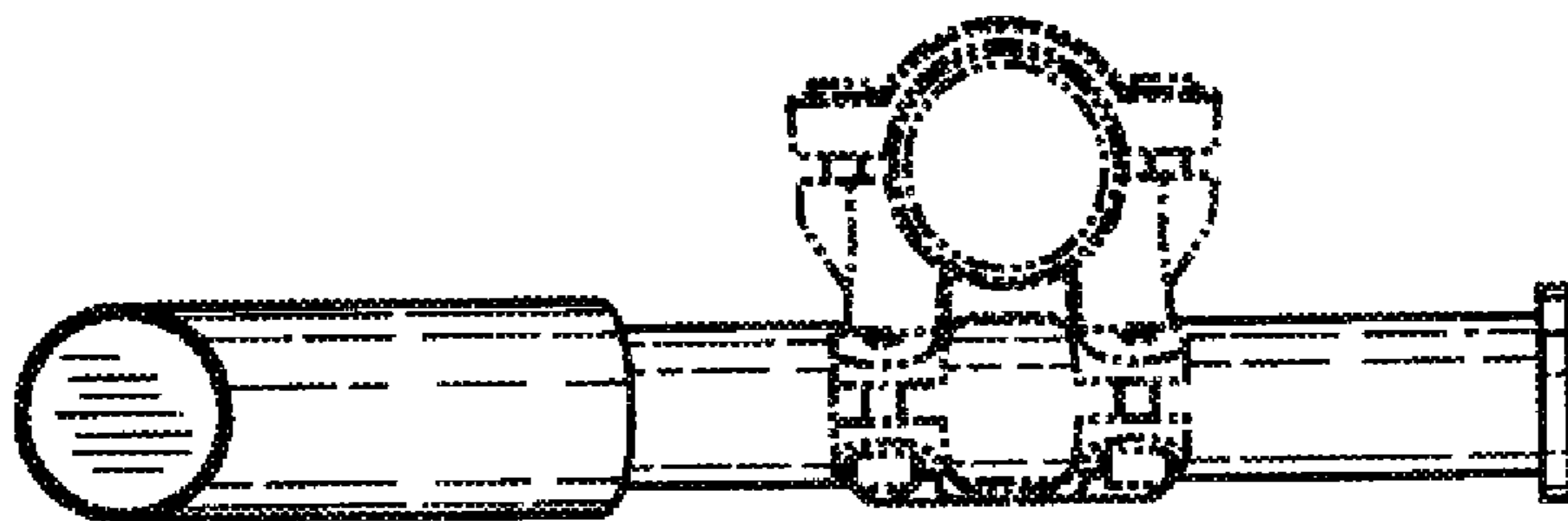

Fig. 4

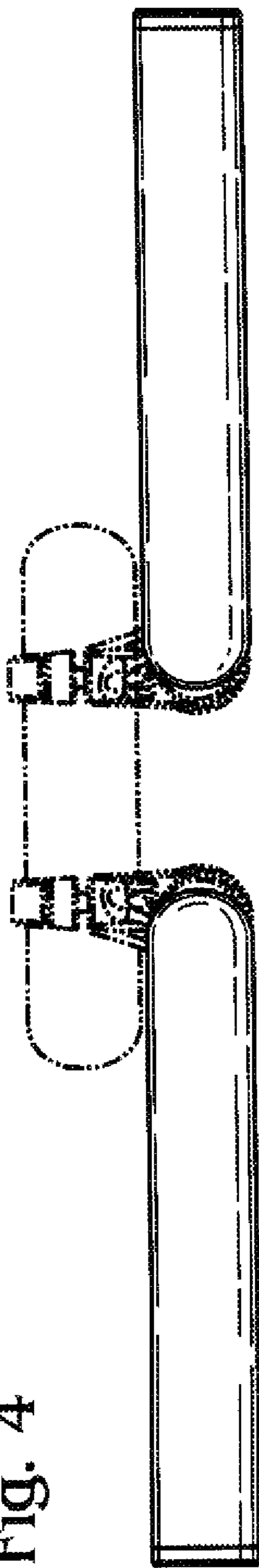

Fig. 5

