



US00D657925S

(12) **United States Design Patent**  
**Luipold**

(10) **Patent No.:** **US D657,925 S**  
(45) **Date of Patent:** **\*\* Apr. 17, 2012**

(54) **CLEANING ARTICLE**

(75) Inventor: **Lee Ann Luipold**, Cincinnati, OH (US)

(73) Assignee: **The Procter & Gamble Company**,  
Cincinnati, OH (US)

(\*\*) Term: **14 Years**

(21) Appl. No.: **29/398,375**

(22) Filed: **Jul. 29, 2011**

(51) **LOC (9) Cl.** ..... **04-01**

(52) **U.S. Cl.** ..... **D32/40**

(58) **Field of Classification Search** ..... D32/40-46;  
D25/110, 152, 153, 157, 158; D5/1, 2, 3,  
D5/4; 15/244.1-244.4, 208, 209.1

See application file for complete search history.

(56) **References Cited**

**U.S. PATENT DOCUMENTS**

D39,059 S	2/1908	Landis
D86,564 S	3/1932	Fuchs
D215,582 S	10/1969	Bogan, Jr.
3,593,819 A	7/1971	Giraudeau
D233,832 S	12/1974	Becker
D411,685 S	6/1999	Thomas
D489,537 S	5/2004	Wong et al.

(Continued)

*Primary Examiner* — Robin V Webster

(74) *Attorney, Agent, or Firm* — John T. Dipre

(57) **CLAIM**

The ornamental design for a cleaning article, as shown and described.

**DESCRIPTION**

FIG. 1 is a front perspective view of a first embodiment of a cleaning article;

FIG. 2 is a top view of the first embodiment of a cleaning article shown in FIG. 1;

FIG. 3 is a right view of the first embodiment of a cleaning article shown in FIG. 1;

FIG. 4 is a left view of the first embodiment of a cleaning article shown in FIG. 1;

FIG. 5 is a back view of the first embodiment of a cleaning article shown in FIG. 1;

FIG. 6 is a front view of the first embodiment of a cleaning article shown in FIG. 1;

FIG. 7 is a bottom view of the first embodiment of a cleaning article shown in FIG. 1;

FIG. 8 is a front perspective view of a second embodiment of a cleaning article;

FIG. 9 is a top view of the second embodiment of a cleaning article shown in FIG. 8;

FIG. 10 is a right view of the second embodiment of a cleaning article shown in FIG. 8;

FIG. 11 is a left view of the second embodiment of a cleaning article shown in FIG. 8;

FIG. 12 is a back view of the second embodiment of a cleaning article shown in FIG. 8;

FIG. 13 is a front view of the second embodiment of a cleaning article shown in FIG. 8;

FIG. 14 is a bottom view of the second embodiment of a cleaning article shown in FIG. 8;

FIG. 15 is a front perspective view of a third embodiment of a cleaning article;

FIG. 16 is a top view of the third embodiment of a cleaning article shown in FIG. 15;

FIG. 17 is a right view of the third embodiment of a cleaning article shown in FIG. 15;

FIG. 18 is a left view of the third embodiment of a cleaning article shown in FIG. 15;

FIG. 19 is a back view of the third embodiment of a cleaning article shown in FIG. 15;

FIG. 20 is a front view of the third embodiment of a cleaning article shown in FIG. 15; and,

FIG. 21 is a bottom view of the third embodiment of a cleaning article shown in FIG. 15.

The broken lines shown in the drawings are for illustrative purposes only and form no part of the claimed design.

**1 Claim, 6 Drawing Sheets**

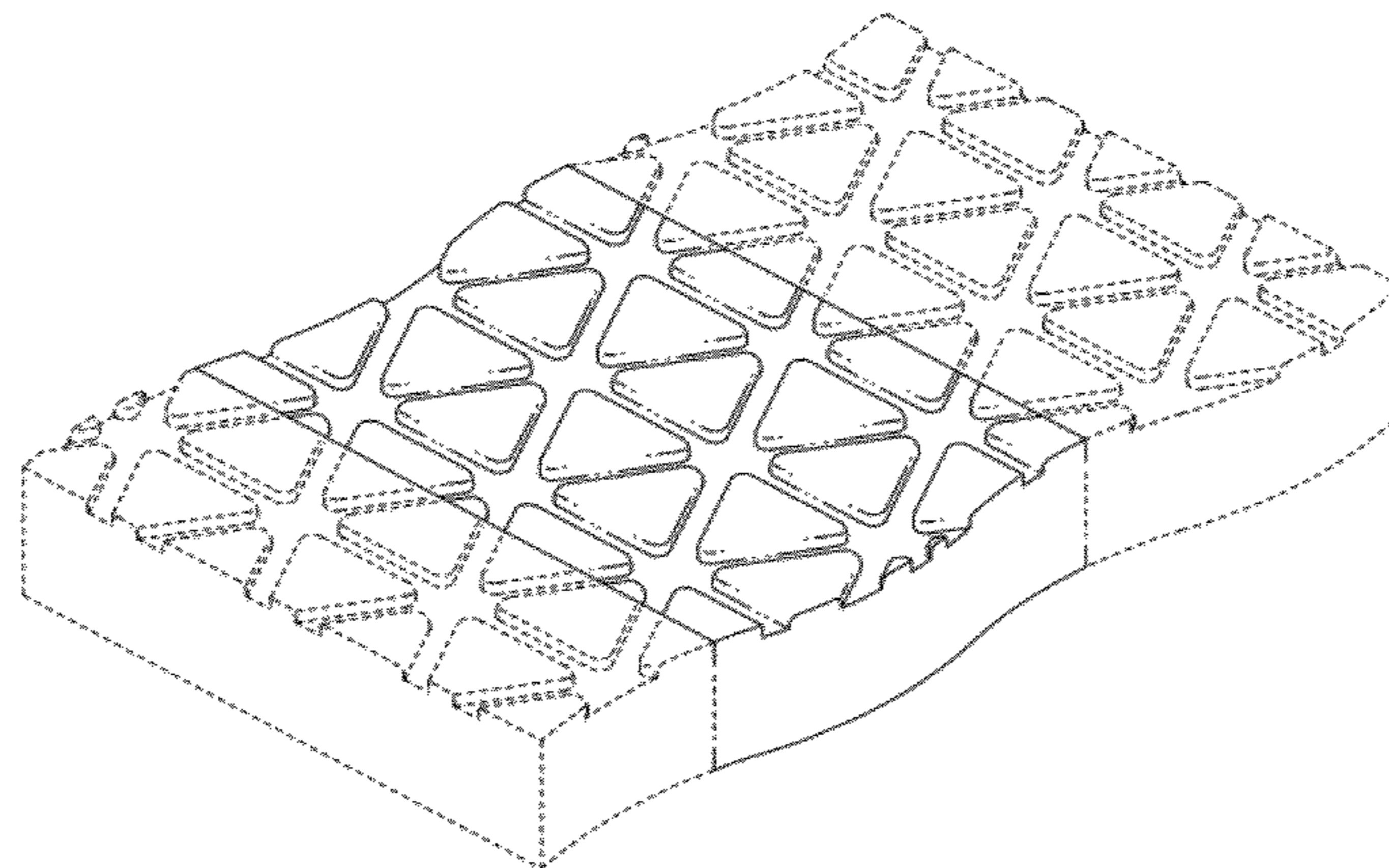

# US D657,925 S

Page 2

---

## U.S. PATENT DOCUMENTS

D499,887 S	*	12/2004	Wong et al. ....	D5/53	D604,469 S	*	11/2009	Rolstad et al. ....	D32/40
D505,528 S		5/2005	Burt et al.		D610,753 S	*	2/2010	Moskowitz ....	D30/158
D506,299 S	*	6/2005	Chumley .....	D32/40	D622,421 S		8/2010	Akkala	
D556,966 S	*	12/2007	Herbrand et al. ....	D32/40	D636,955 S	*	4/2011	Armaly, Jr. ....	D32/40
D577,167 S	*	9/2008	Bogaerts et al. ....	D32/40	D641,527 S	*	7/2011	Regnier et al. ....	D32/40
D587,416 S		2/2009	Ashe						

\* cited by examiner



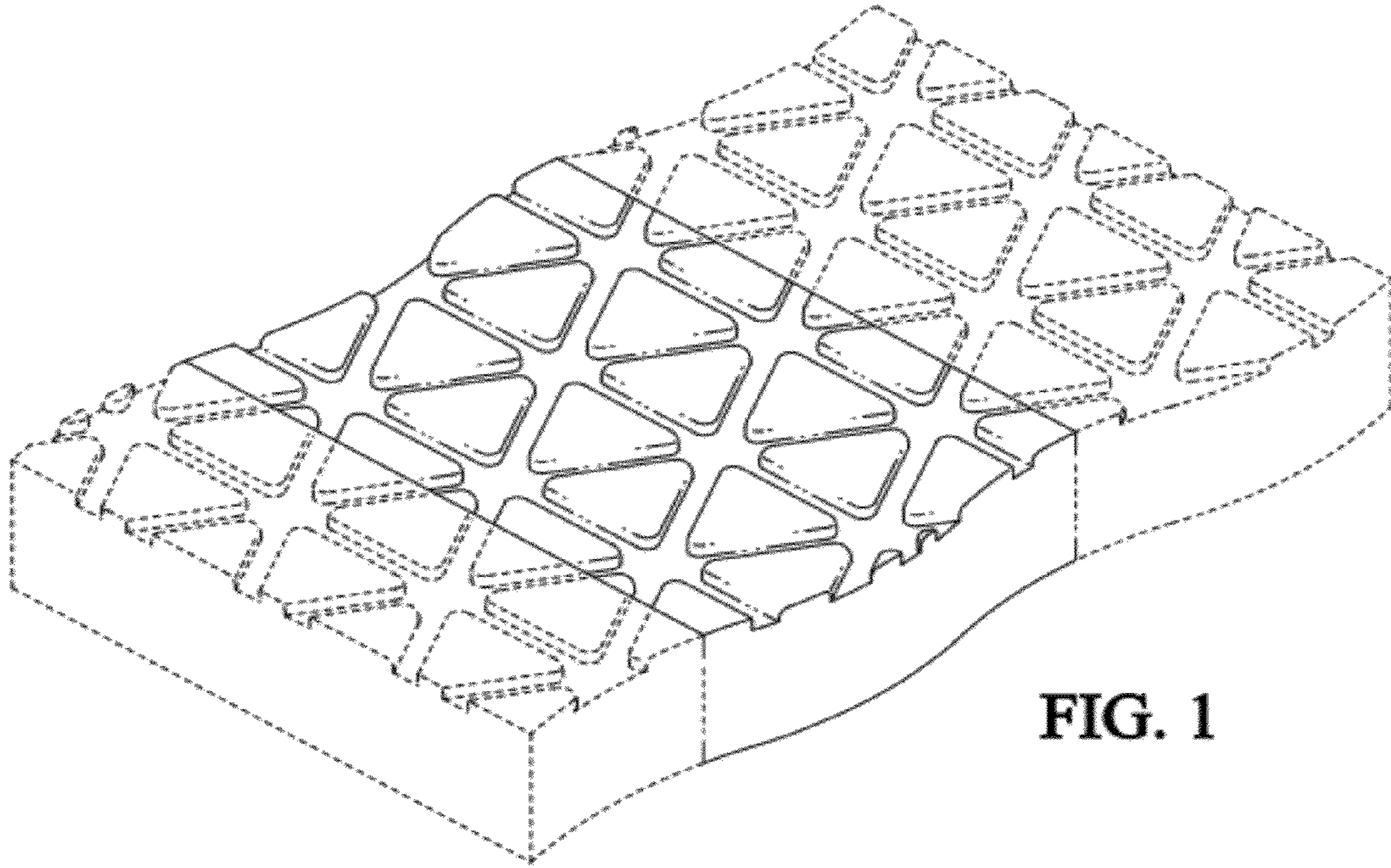

FIG. 1

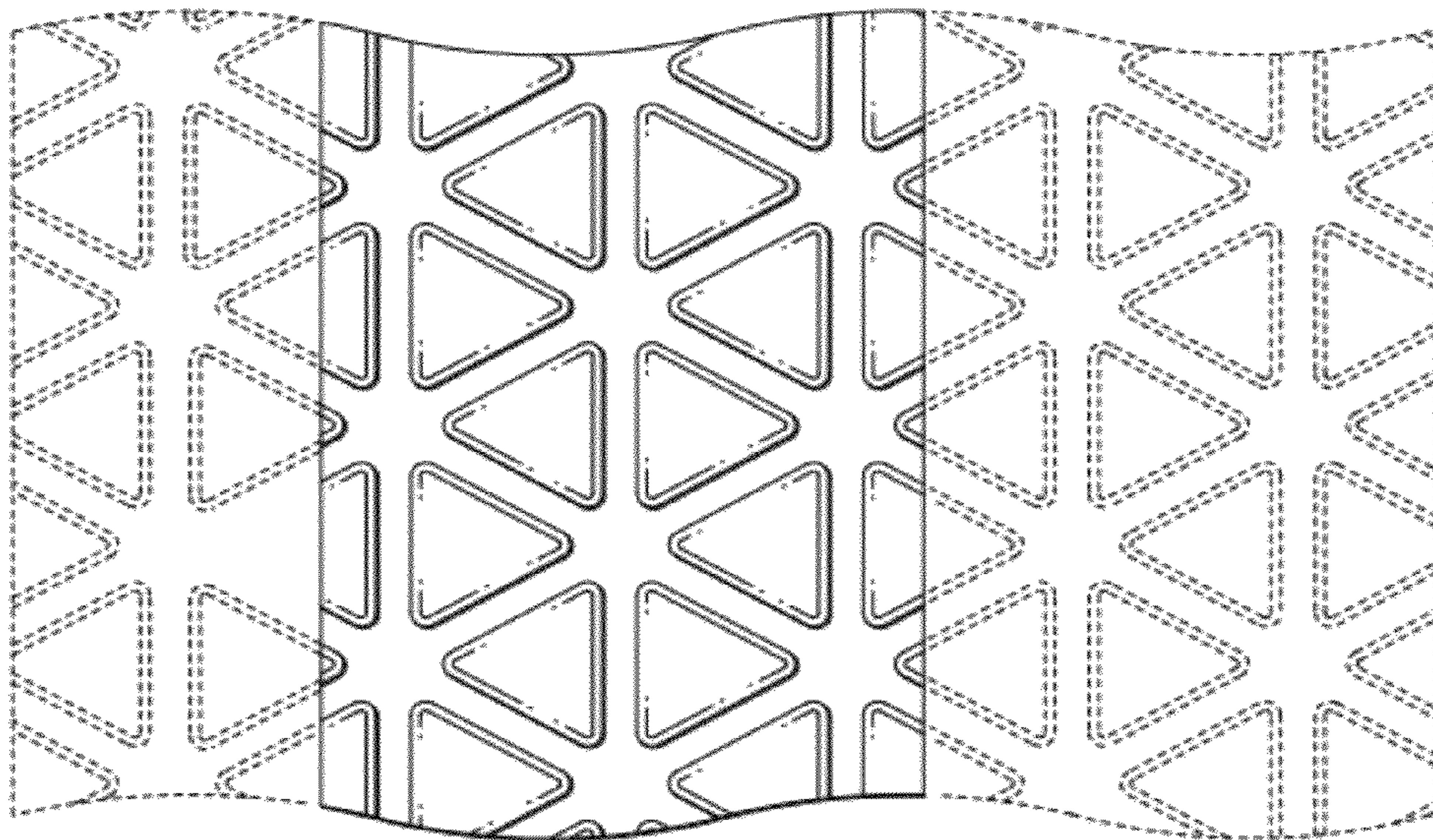

FIG. 2

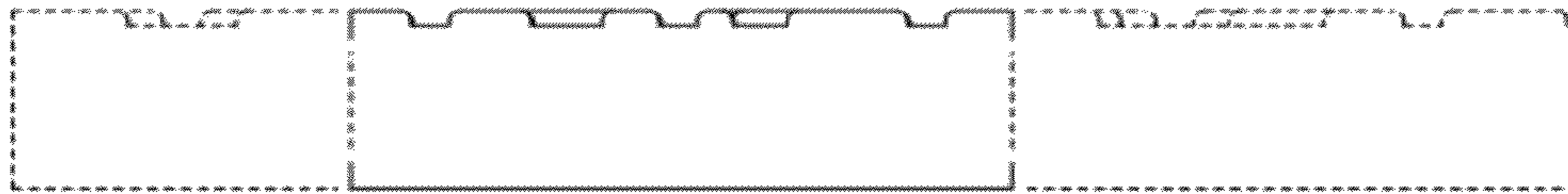

FIG. 3

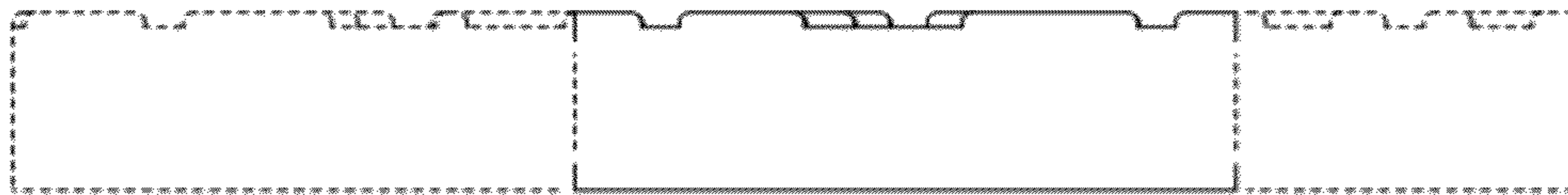

FIG. 4



FIG. 5

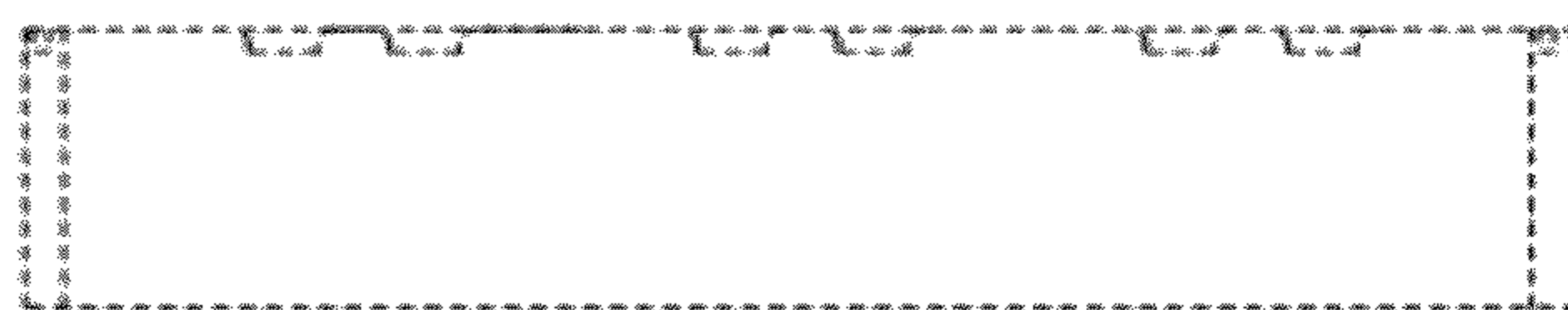

FIG. 6

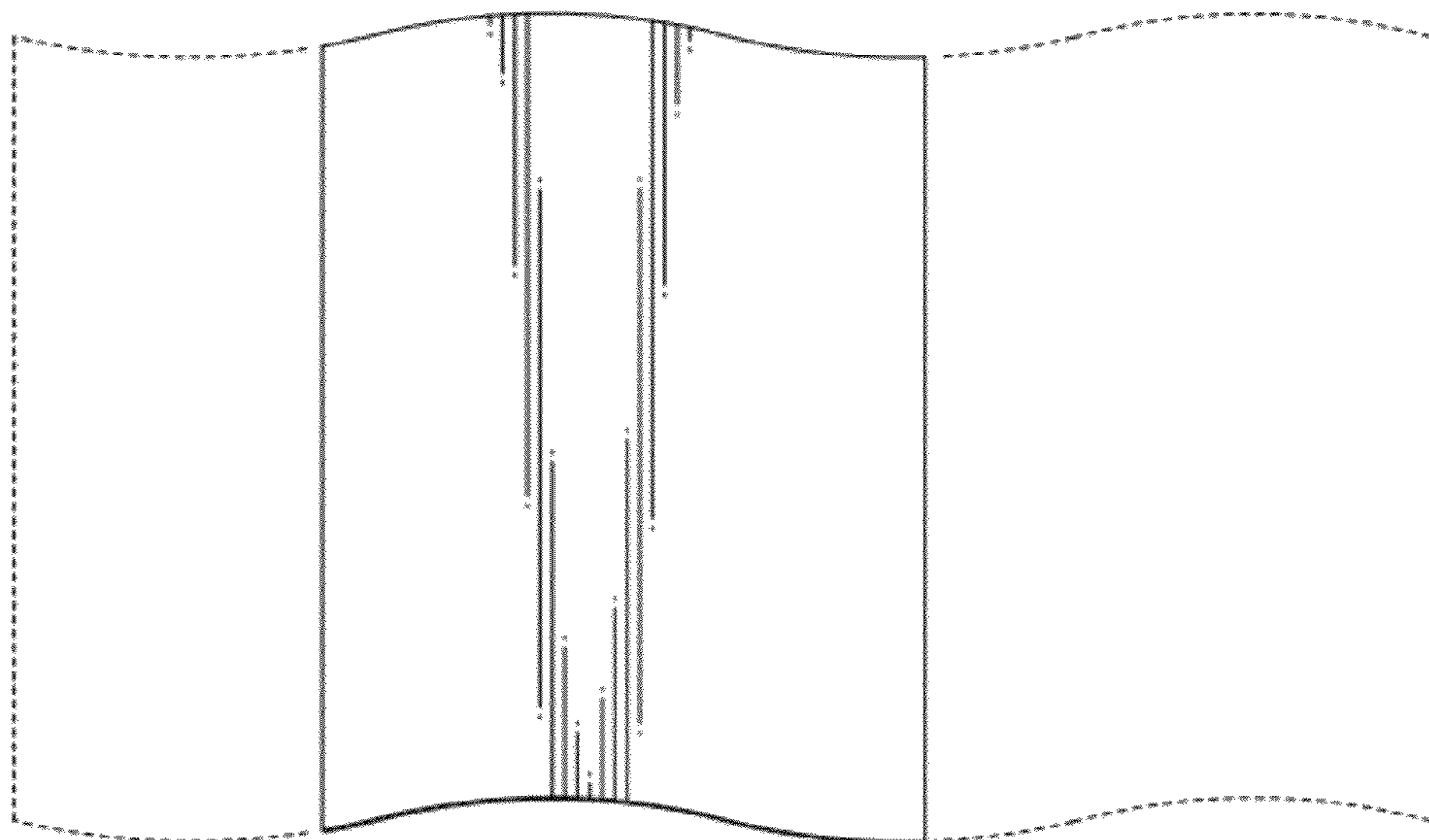

FIG. 7



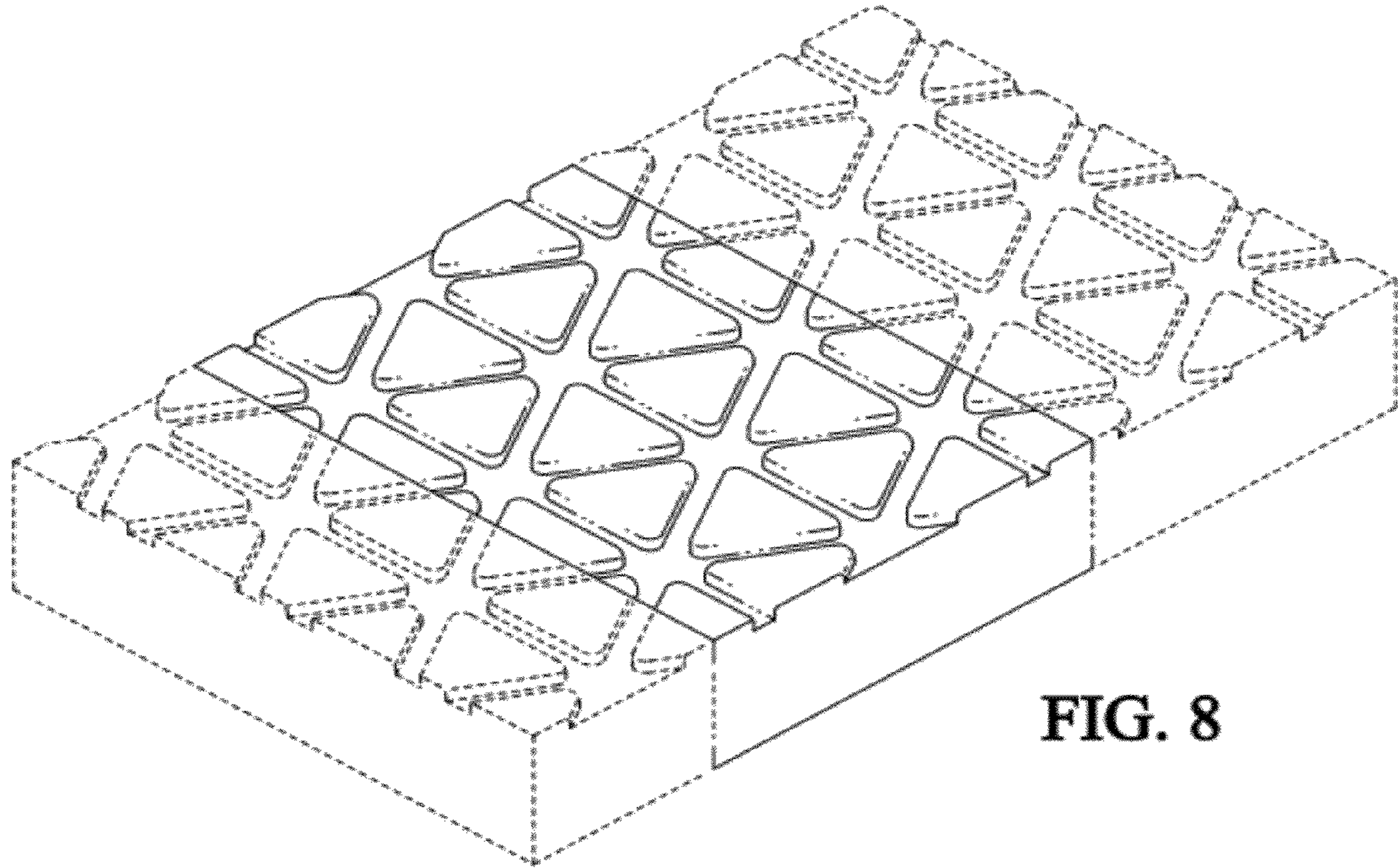

FIG. 8

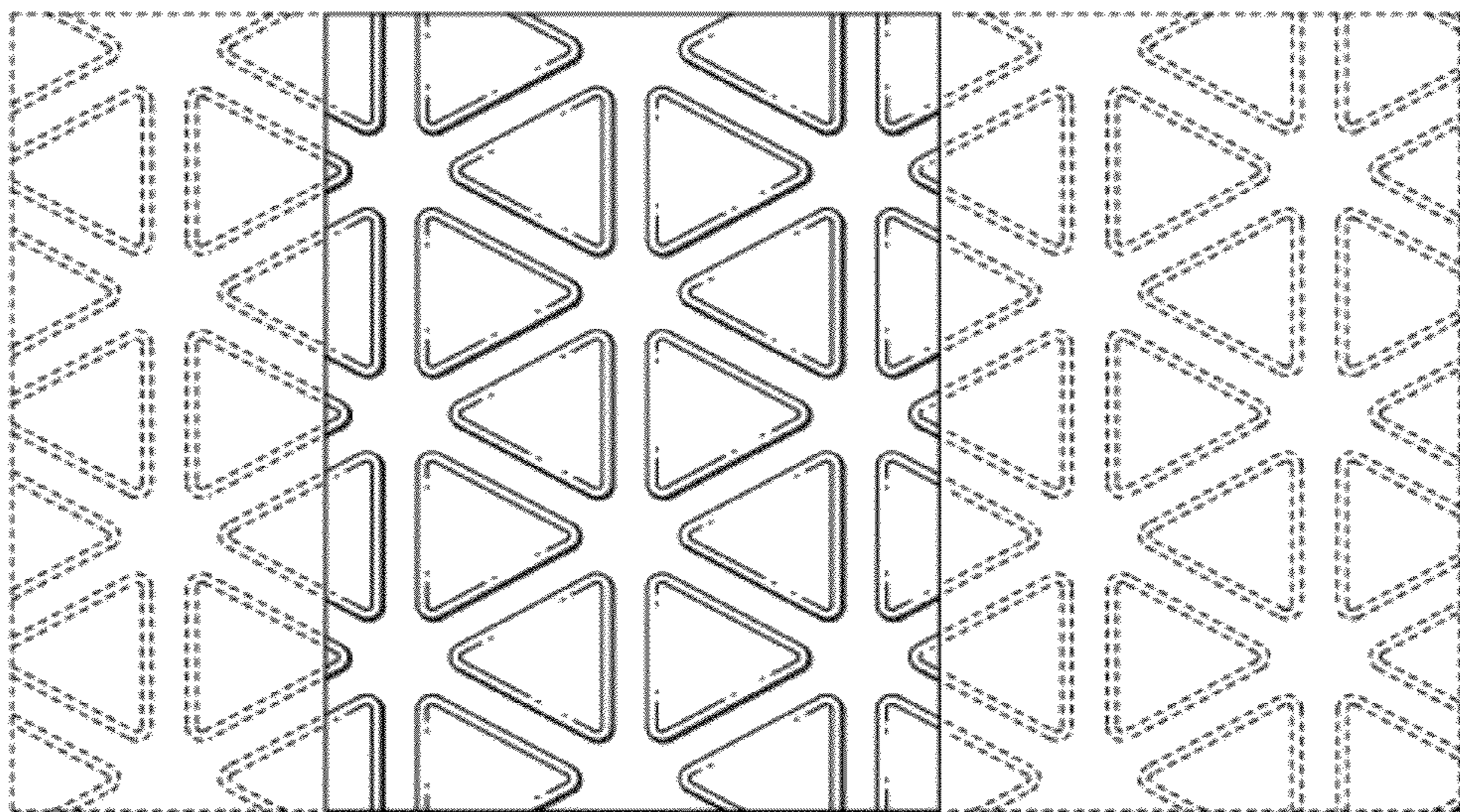

FIG. 9

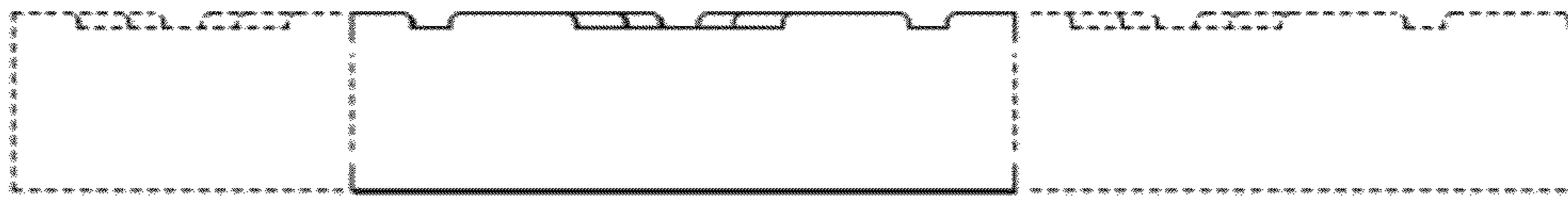

FIG. 10

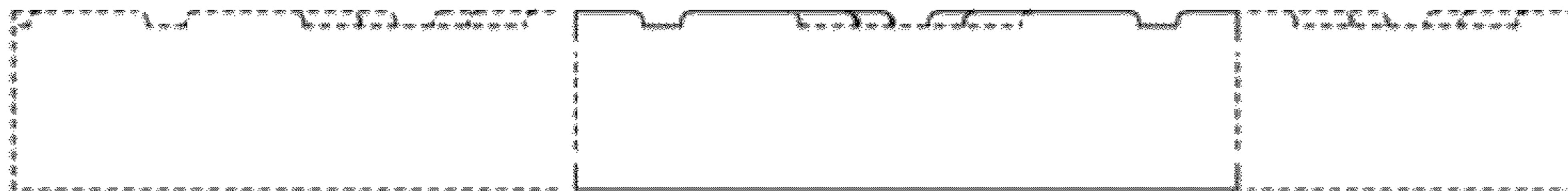

FIG. 11



FIG. 12

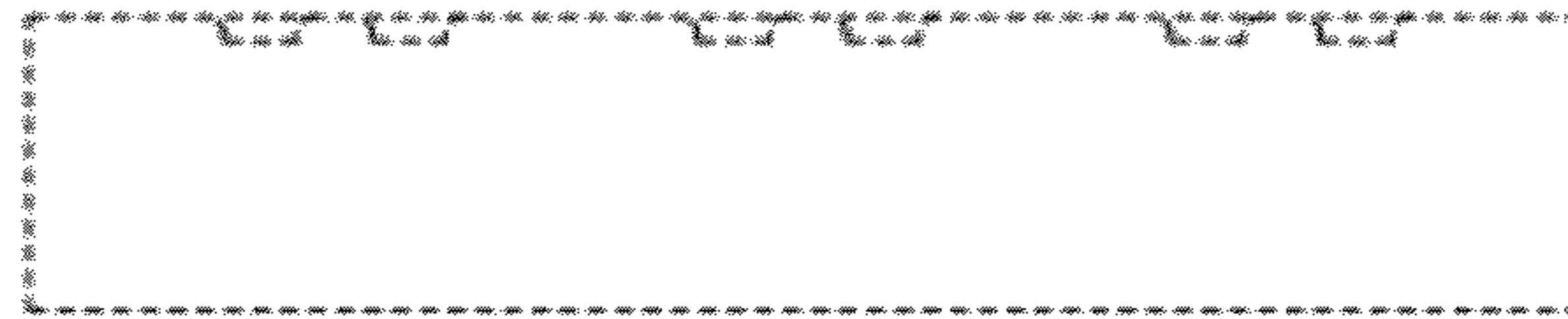

FIG. 13

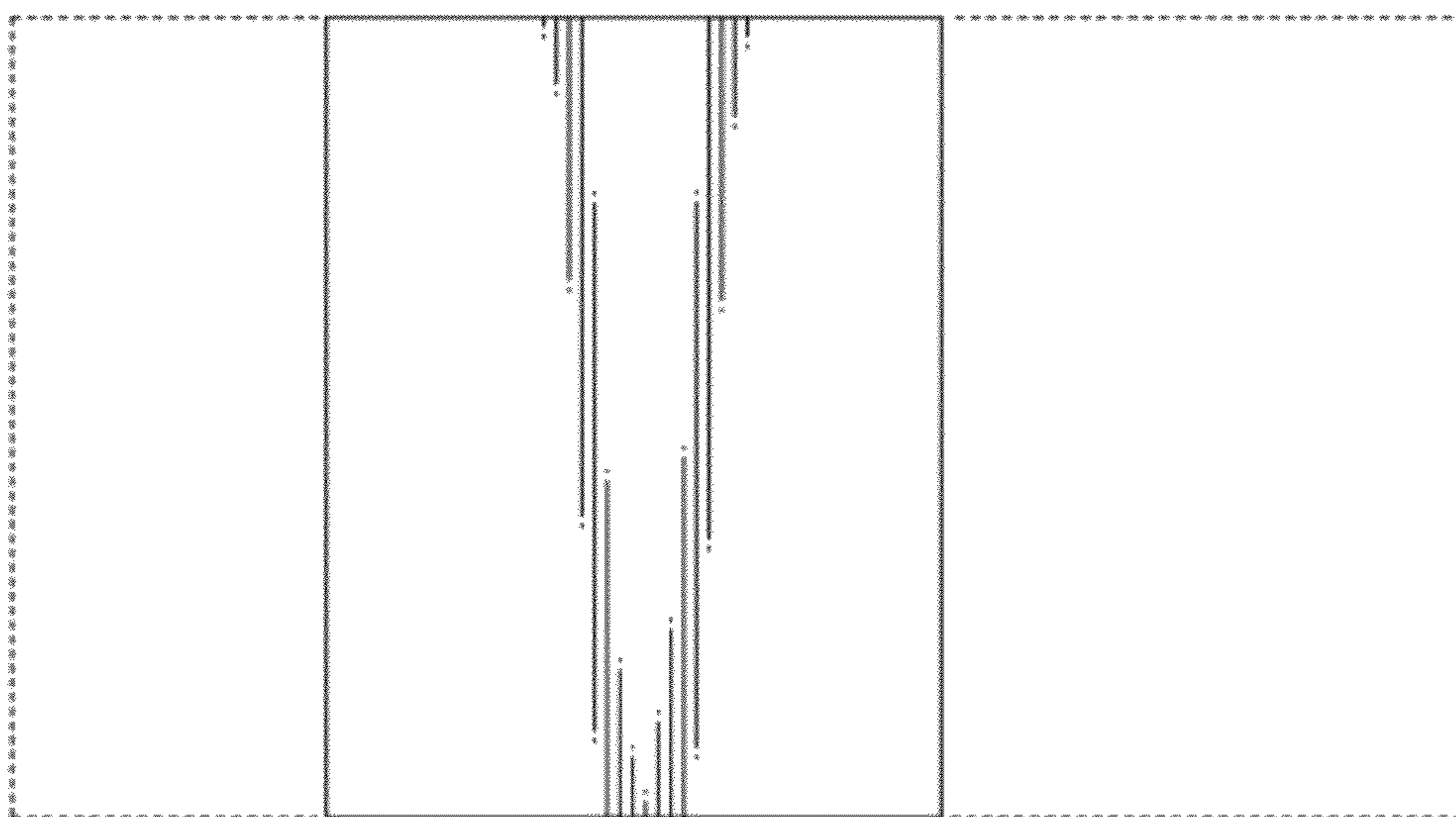

FIG. 14



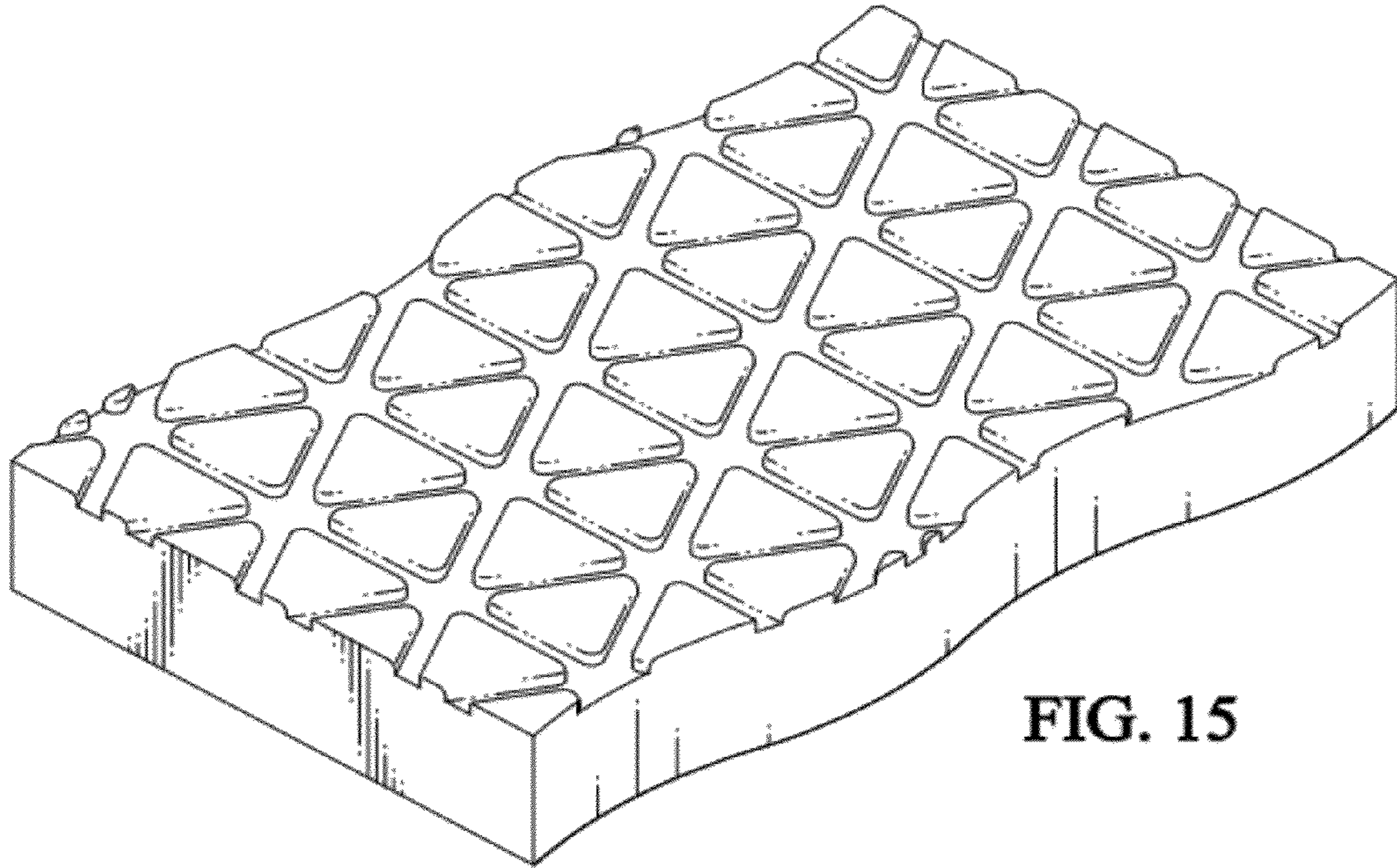

FIG. 15

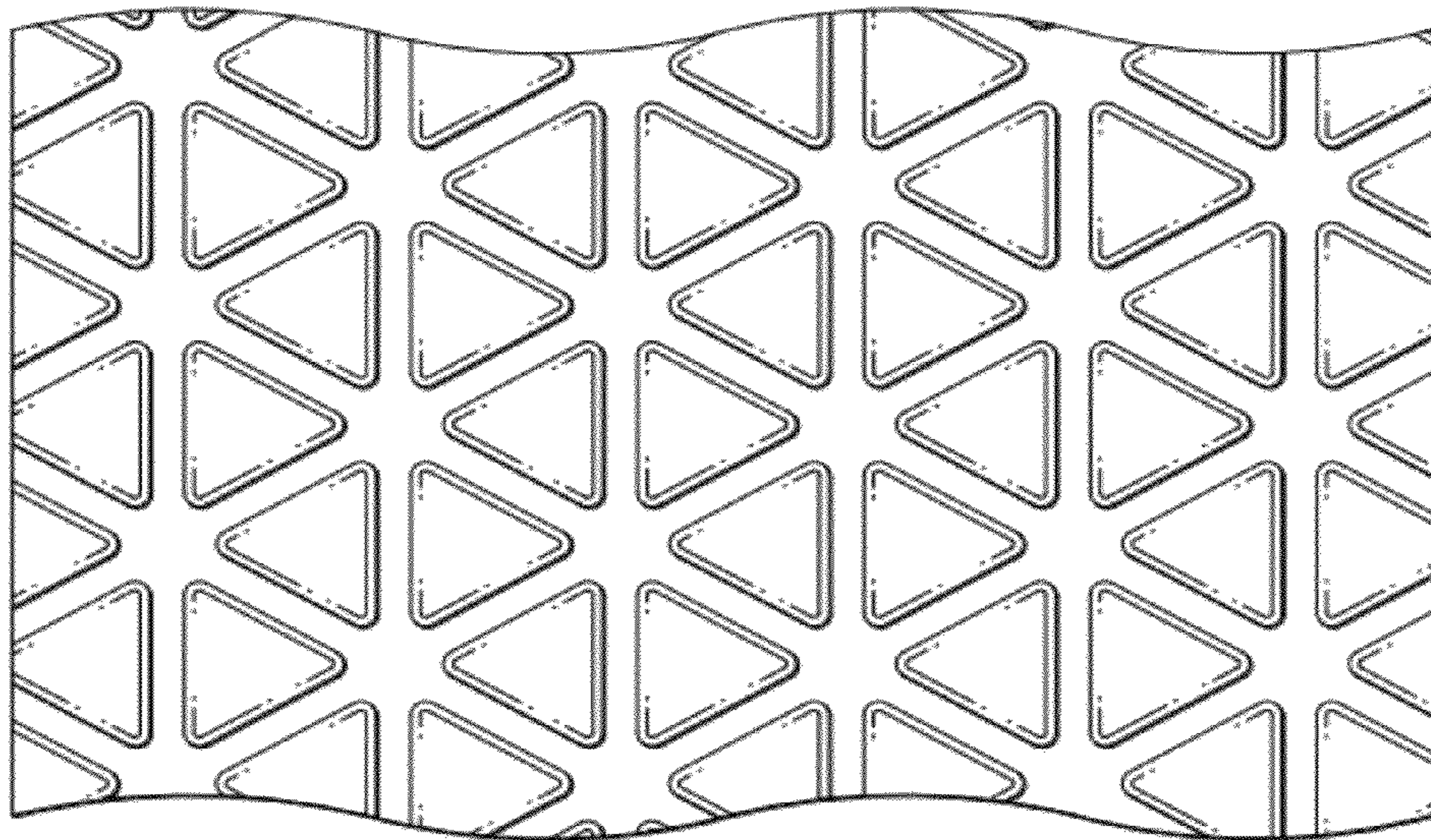

FIG. 16

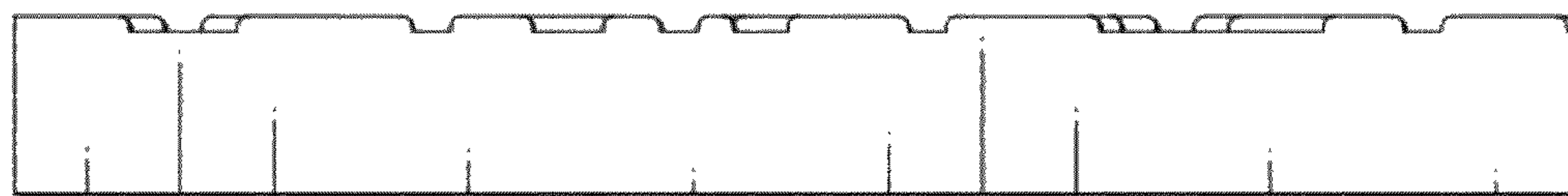

FIG. 17

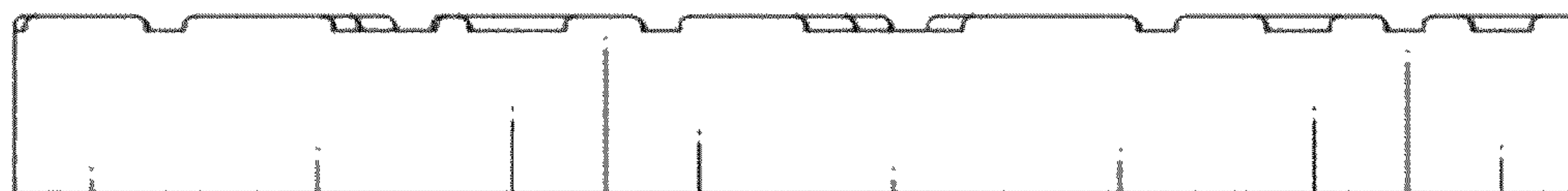

FIG. 18

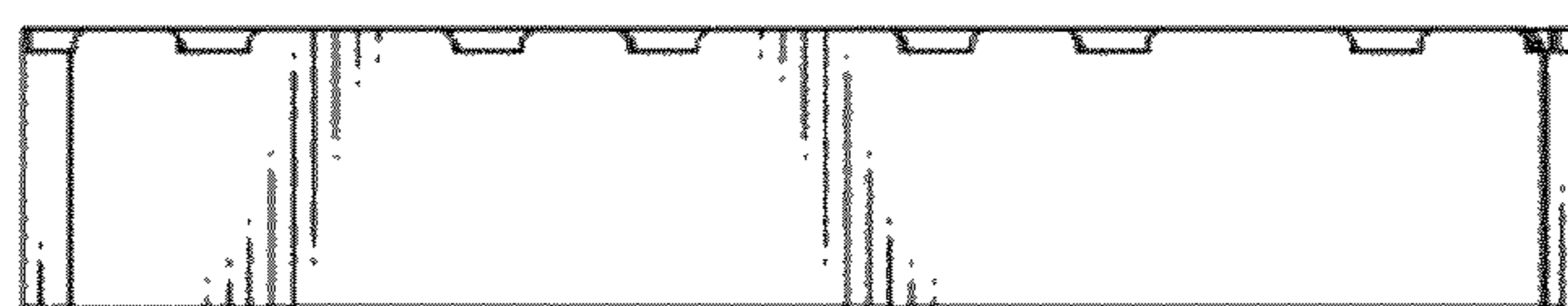

FIG. 19

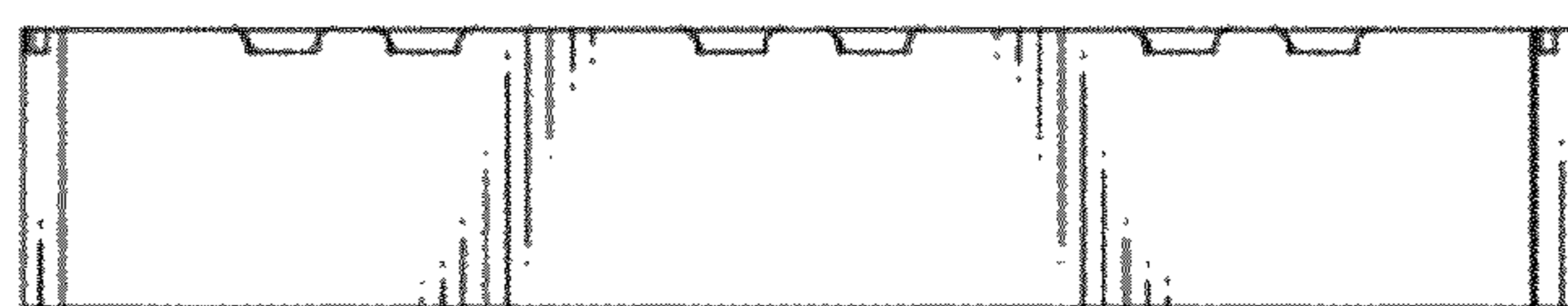

FIG. 20

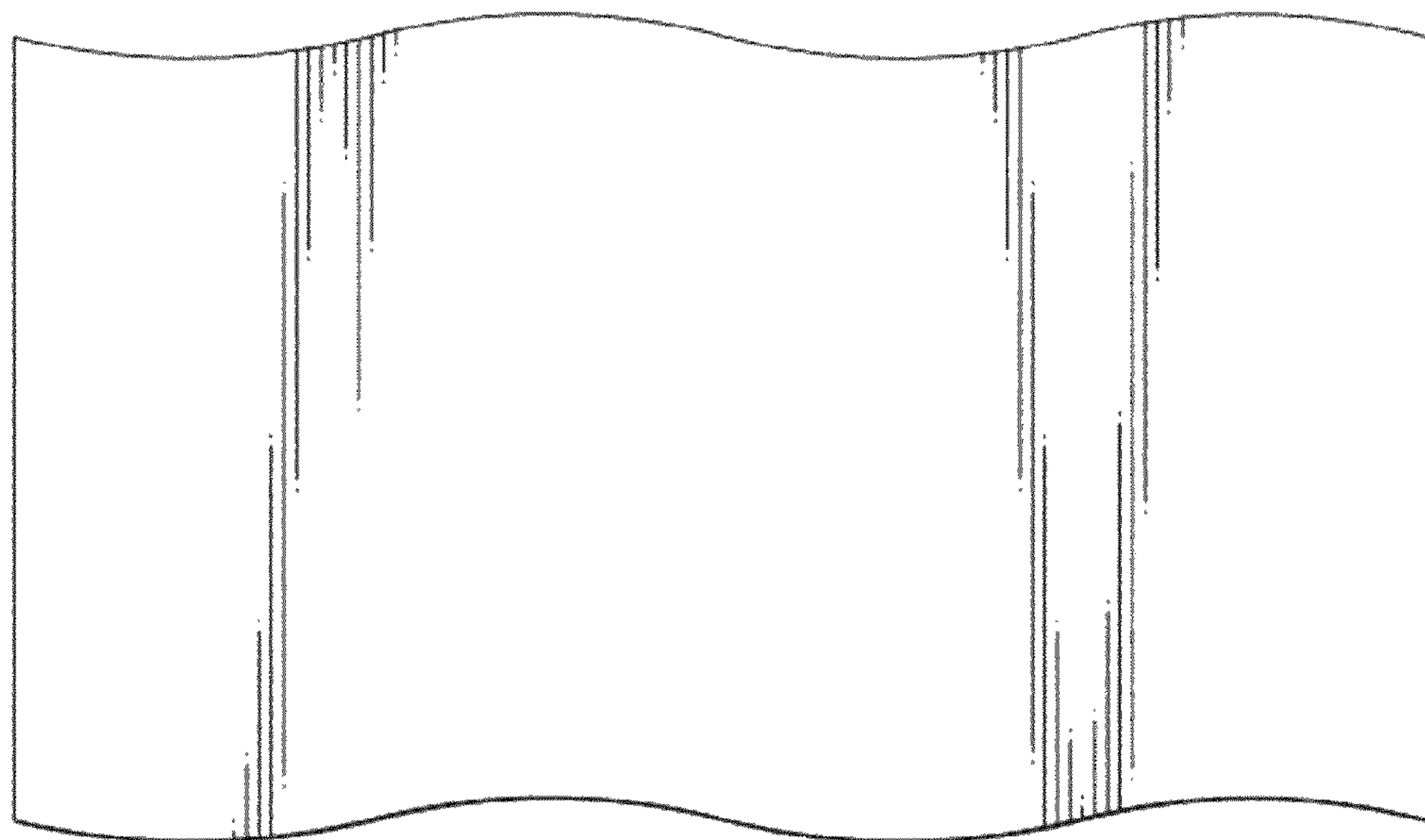

FIG. 21