



US00D657867S

(12) **United States Design Patent**
Effenberger

(10) **Patent No.:** **US D657,867 S**

(45) **Date of Patent:** **** Apr. 17, 2012**

(54) **SYRINGE**

(75) Inventor: **Steffen Effenberger**, Hamburg (DE)

(73) Assignee: **DMG Chemisch Pharmazeutische Fabrik GmbH**, Hamburg (DE)

(**) Term: **14 Years**

(21) Appl. No.: **29/316,056**

(22) Filed: **Aug. 18, 2009**

(30) **Foreign Application Priority Data**

Mar. 17, 2009 (EM) 001106181-0001

(51) **LOC (9) Cl.** **24-02**

(52) **U.S. Cl.** **D24/114**

(58) **Field of Classification Search** D24/112-114,
D24/133, 186, 104, 130, 127; 606/181, 185,
606/93; 604/504, 232, 187, 158, 164.08,
604/192, 263, 163, 181, 184, 198, 227, 264,
604/110, 210, 221, 214, 211, 218; 222/390;
433/90

See application file for complete search history.

(56) **References Cited**

U.S. PATENT DOCUMENTS

4,269,331	A *	5/1981	Watson	222/390
4,312,343	A *	1/1982	LeVeen et al.	604/211
D274,838	S *	7/1984	Shadwell	D24/114
4,810,249	A *	3/1989	Haber et al.	604/210
5,618,273	A *	4/1997	Fischer	604/211
D401,324	S *	11/1998	Hjertman et al.	D24/114
D401,325	S *	11/1998	Hjertman et al.	D24/114
D421,121	S *	2/2000	Prasad et al.	D24/114
6,638,065	B2 *	10/2003	Fischer et al.	433/90
6,712,794	B2 *	3/2004	Kust et al.	604/211
D574,954	S *	8/2008	Smith	D24/114
D578,210	S *	10/2008	Muta et al.	D24/114
D610,253	S *	2/2010	Kawamura	D24/114

* cited by examiner

Primary Examiner — David Muller

(74) *Attorney, Agent, or Firm* — Fross, Zelnick, Lehrman & Zissu, P.C.; Charles T. J. Weigell, Esq.

(57) **CLAIM**

The ornamental design for a syringe, as shown and described.

DESCRIPTION

FIG. 1 is a top perspective view of a first embodiment of a syringe showing my new design, with a transparent cap. FIG. 2 is an underside perspective view thereof; FIG. 3 is a front elevation view thereof; FIG. 4 is a rear elevation view thereof; FIG. 5 is a right side elevation view thereof; FIG. 6 is a left side elevation view thereof; FIG. 7 is a bottom plan view thereof; FIG. 8 is a top plan view thereof; FIG. 9 is a top perspective view of a second embodiment of the syringe shown in FIG. 1, with a translucent cap. FIG. 10 is an underside perspective view thereof; FIG. 11 is a front elevation view thereof; FIG. 12 is a rear elevation view thereof; FIG. 13 is a right side elevation view thereof; FIG. 14 is a left side elevation view thereof; FIG. 15 is a bottom plan view thereof; FIG. 16 is a top plan view thereof; FIG. 17 is a top perspective view of a third embodiment of the syringe shown in FIG. 1, with an opaque cap. FIG. 18 is an underside perspective view thereof; FIG. 19 is a front elevation view thereof; FIG. 20 is a rear elevation view thereof; FIG. 21 is a right side elevation view thereof; FIG. 22 is a left side elevation view thereof; FIG. 23 is a bottom plan view thereof; and, FIG. 24 is a top plan view thereof.

The portion of the screw and syringe shown in broken lines in FIGS. 1-16 depict environmental subject matter only and form no part of the claimed design.

1 Claim, 12 Drawing Sheets

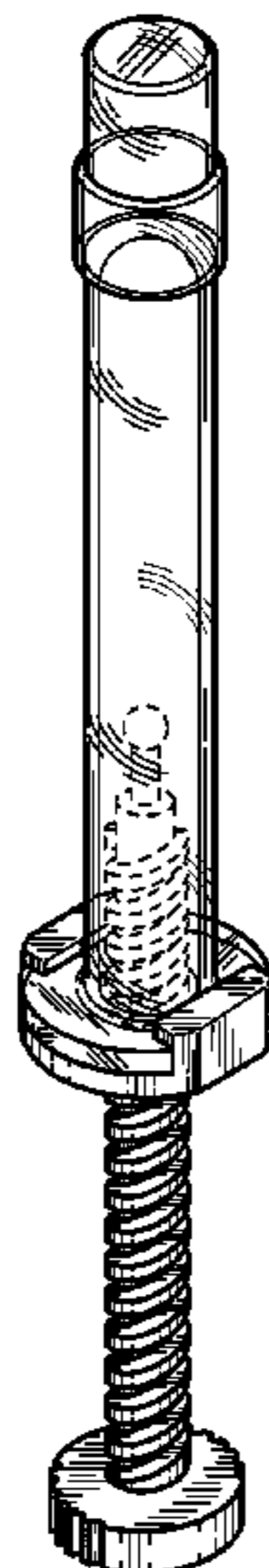

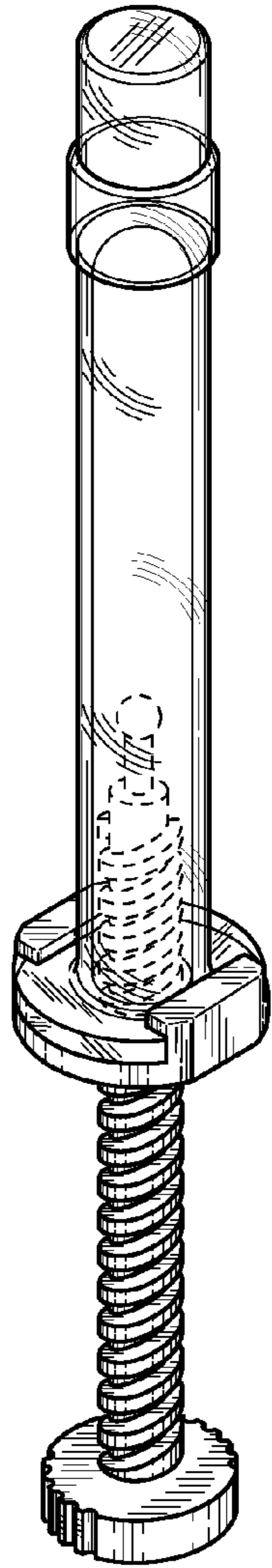

FIG. 1

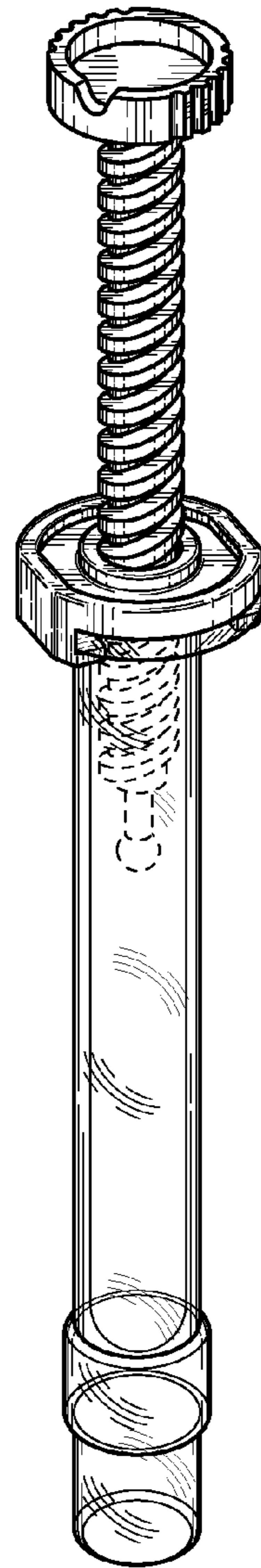

FIG. 2

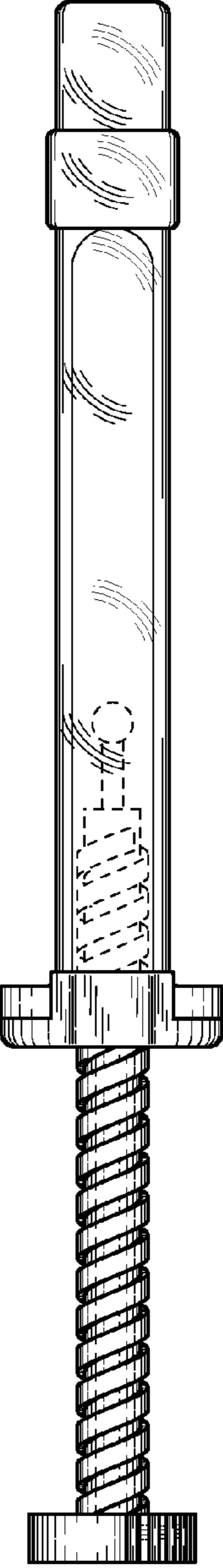

FIG. 3

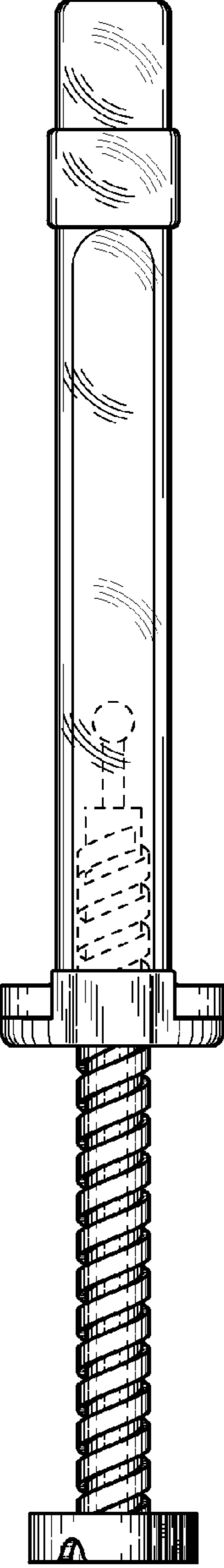

FIG. 4

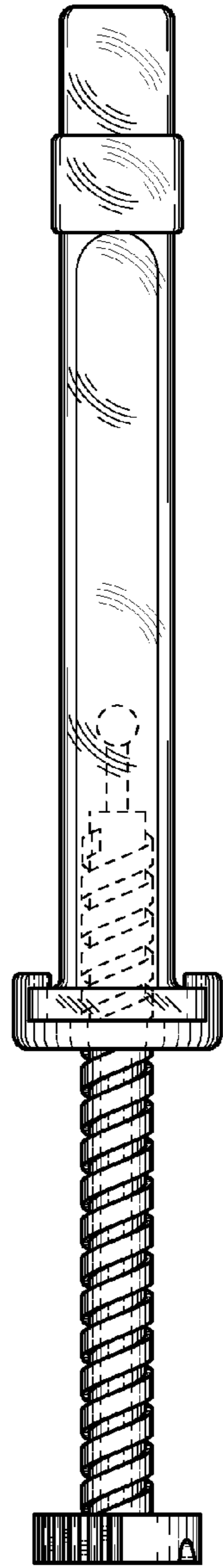

FIG. 5

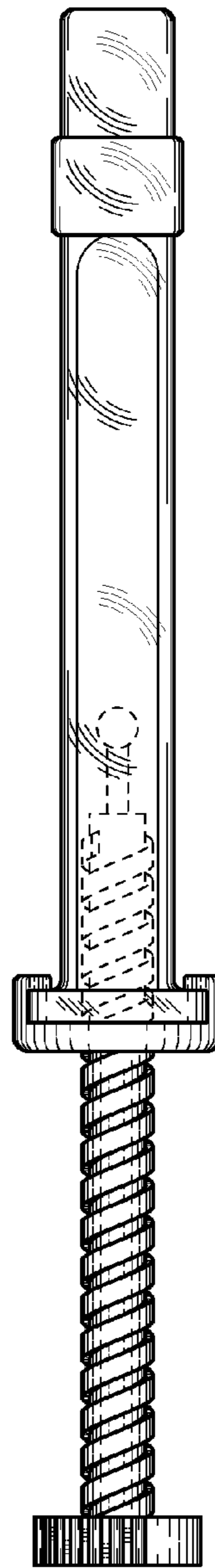

FIG. 6

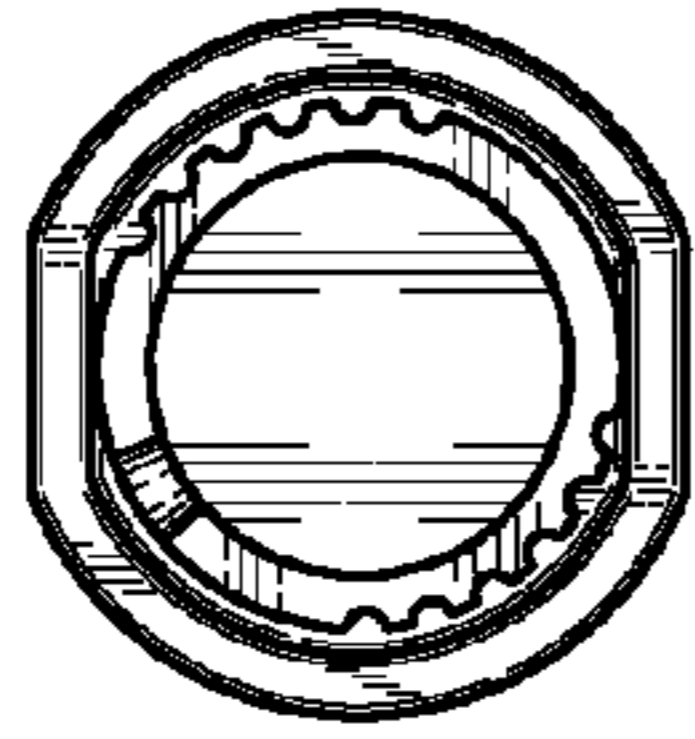

FIG. 7

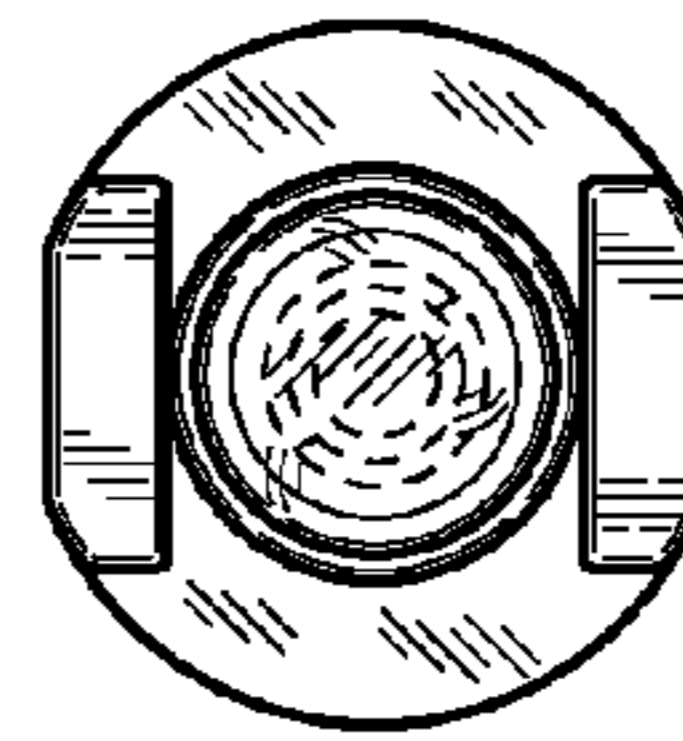

FIG. 8

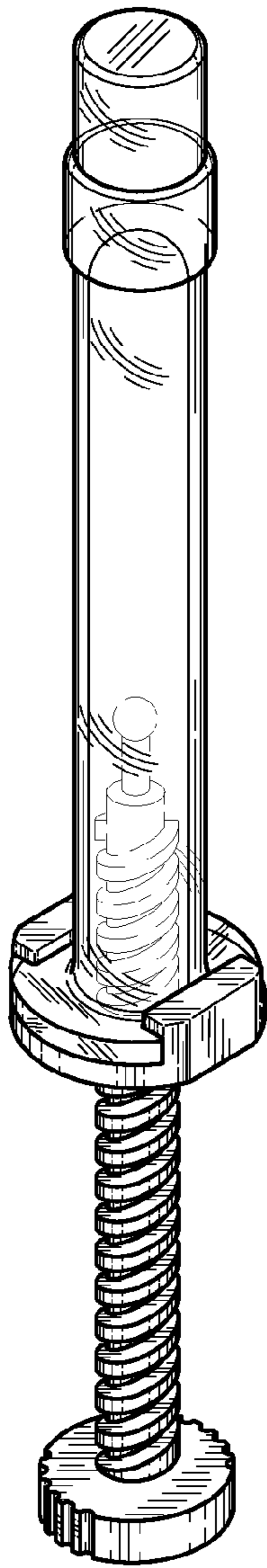

FIG. 9

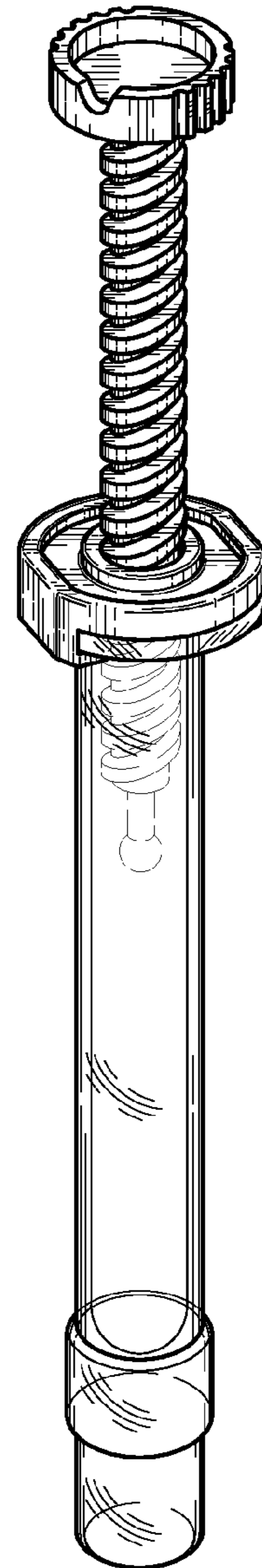

FIG. 10

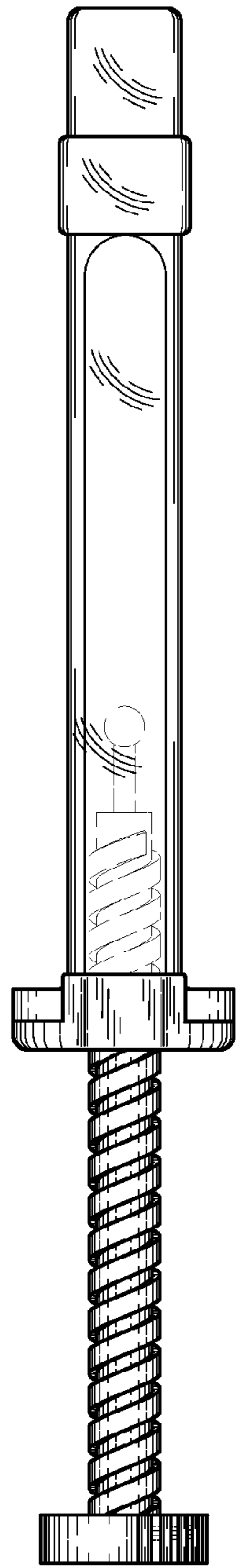

FIG. 11

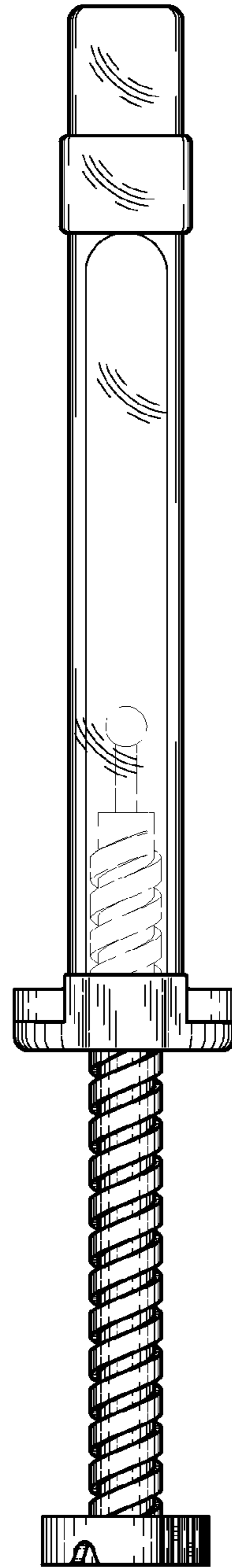

FIG. 12

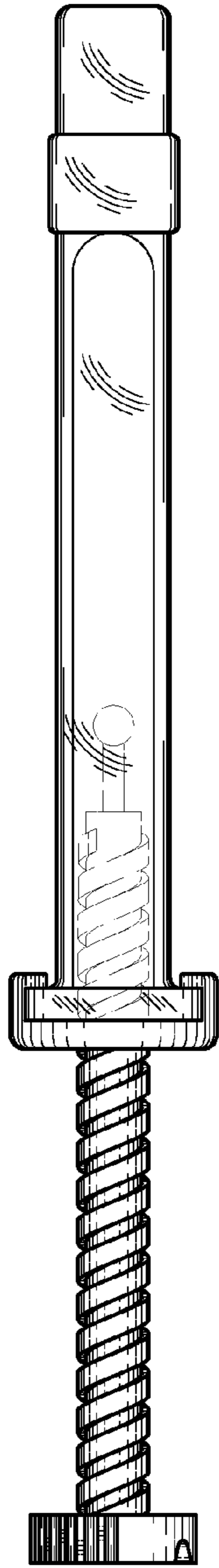

FIG. 13

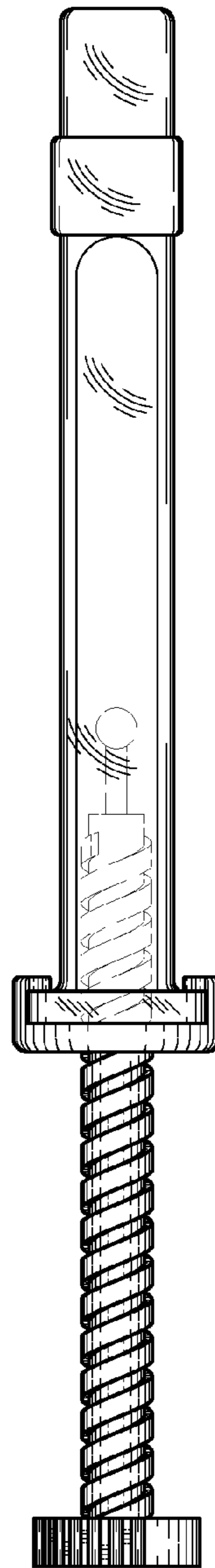

FIG. 14

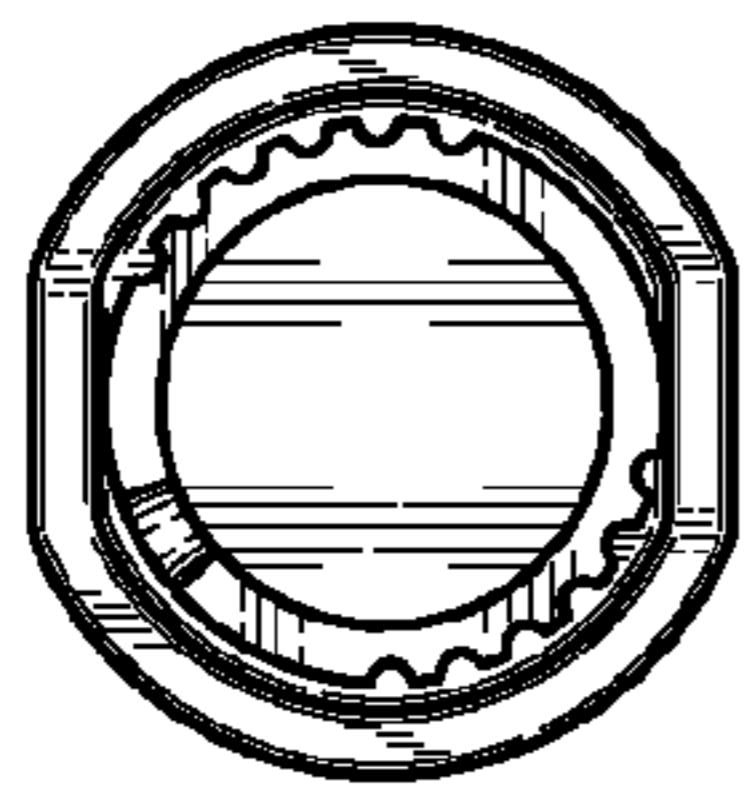

FIG. 15

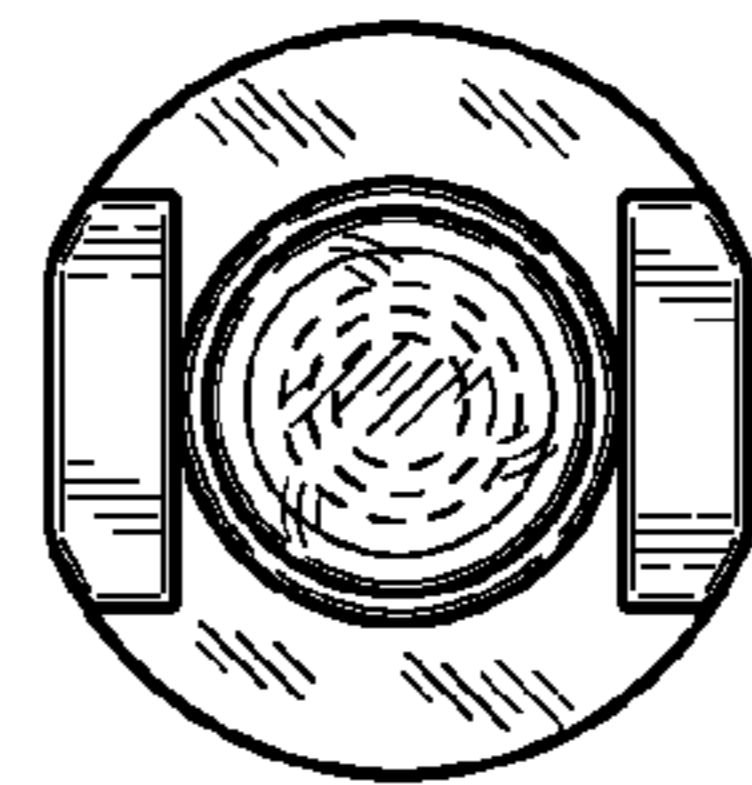

FIG. 16

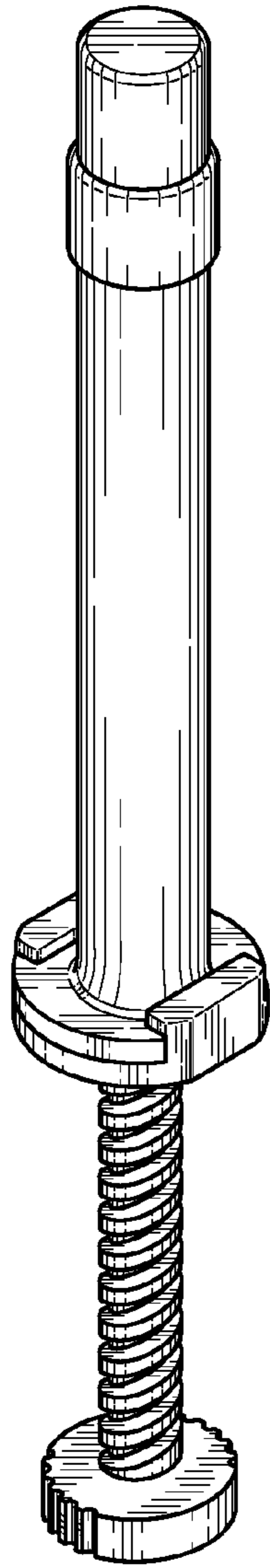

FIG. 17

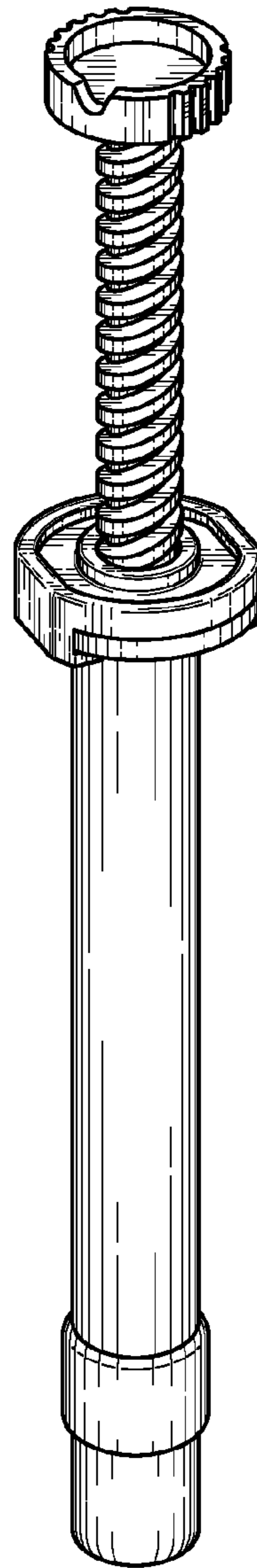

FIG. 18

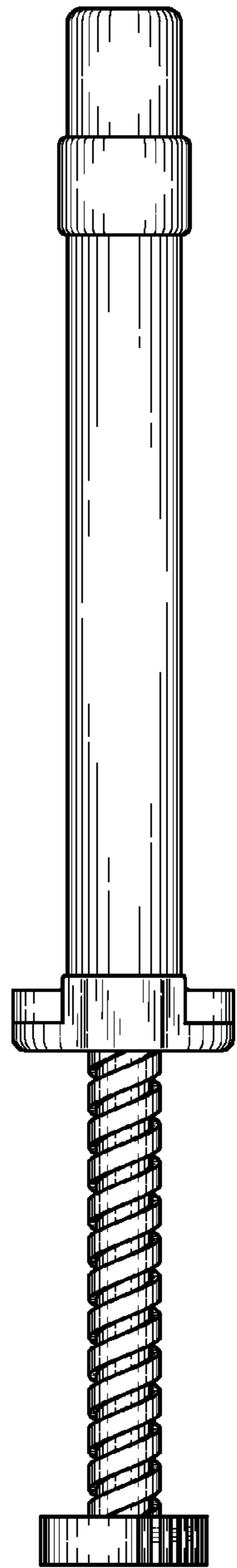

FIG. 19

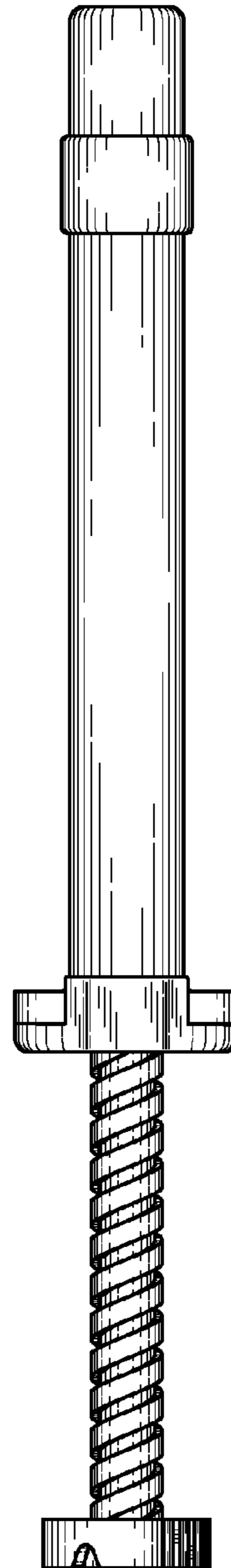

FIG. 20

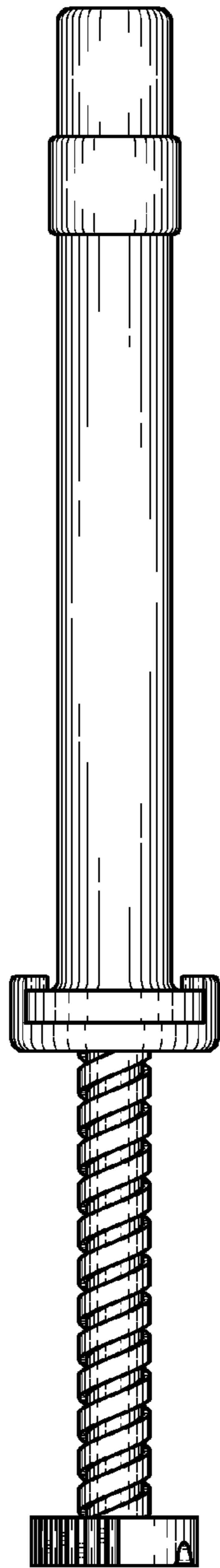

FIG. 21

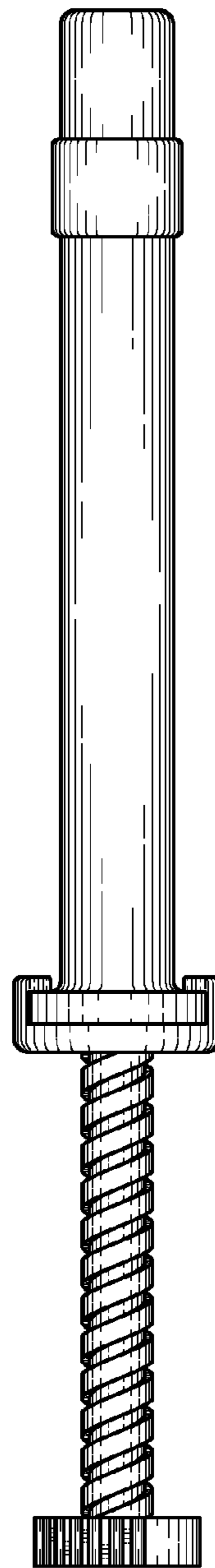

FIG. 22



FIG. 23

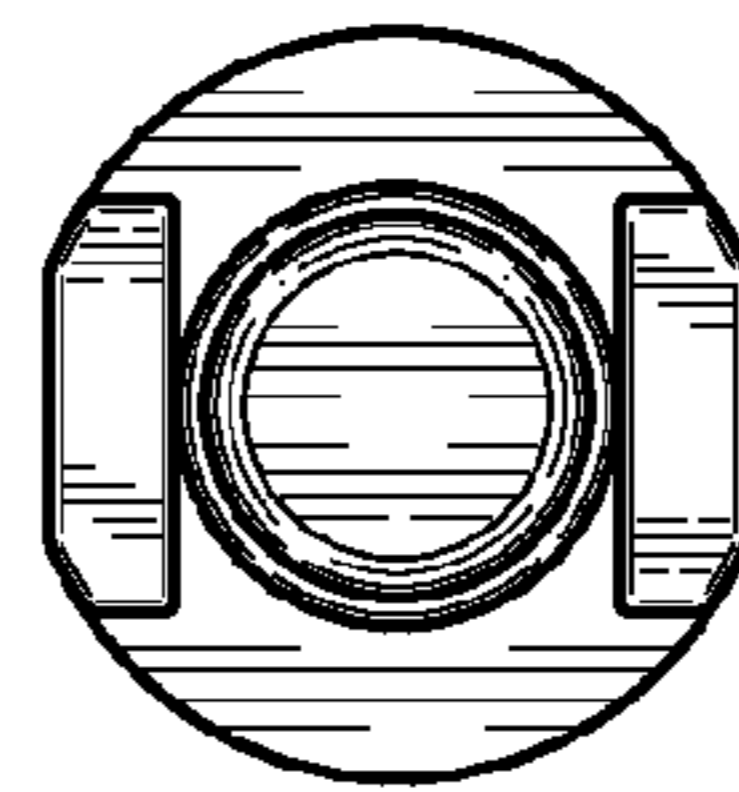

FIG. 24