

US00D657722S

(12) **United States Design Patent**
Lambri et al.

(10) **Patent No.:** **US D657,722 S**
(45) **Date of Patent:** **** Apr. 17, 2012**

(54) **MOTOR SCOOTER**

(75) Inventors: **Marco Lambri**, Pontedera (IT);
Riccardo Minuti, Pontedera (IT)

(73) Assignee: **Piaggio & C. S.p.A.**, Pontedera (PI) (IT)

(**) Term: **14 Years**

(21) Appl. No.: **29/381,348**

(22) Filed: **Dec. 17, 2010**

(30) **Foreign Application Priority Data**

Nov. 29, 2010 (EM) 001787078

(51) **LOC (9) Cl.** **12-11**

(52) **U.S. Cl.** **D12/110**

(58) **Field of Classification Search** D12/110;
180/219, 220, 225, 229

See application file for complete search history.

(56) **References Cited**

U.S. PATENT DOCUMENTS

D503,907 S * 4/2005 Beggio D12/110
D599,710 S * 9/2009 Chen et al. D12/110
D602,402 S * 10/2009 Takahashi et al. D12/110

D602,813 S * 10/2009 Chao et al. D12/110
D627,264 S * 11/2010 Huang et al. D12/110
D632,227 S * 2/2011 Lambri D12/110

* cited by examiner

Primary Examiner — Susan M Lee

Assistant Examiner — Linda G. Brooks

(74) *Attorney, Agent, or Firm* — Hedman & Costigan, P.C.;
Kathleen A. Costigan

(57) **CLAIM**

The ornamental design for a motor scooter, as shown and described.

DESCRIPTION

FIG. 1 is a front, left side perspective view of the motor scooter;

FIG. 2 is a front view thereof;

FIG. 3 is a rear view thereof;

FIG. 4 is a left side view thereof;

FIG. 5 is a right side view thereof;

FIG. 6 is a top view thereof; and,

FIG. 7 is a bottom view thereof.

The broken lines illustrate portions of the motor scooter that form no part of the claimed design.

1 Claim, 7 Drawing Sheets

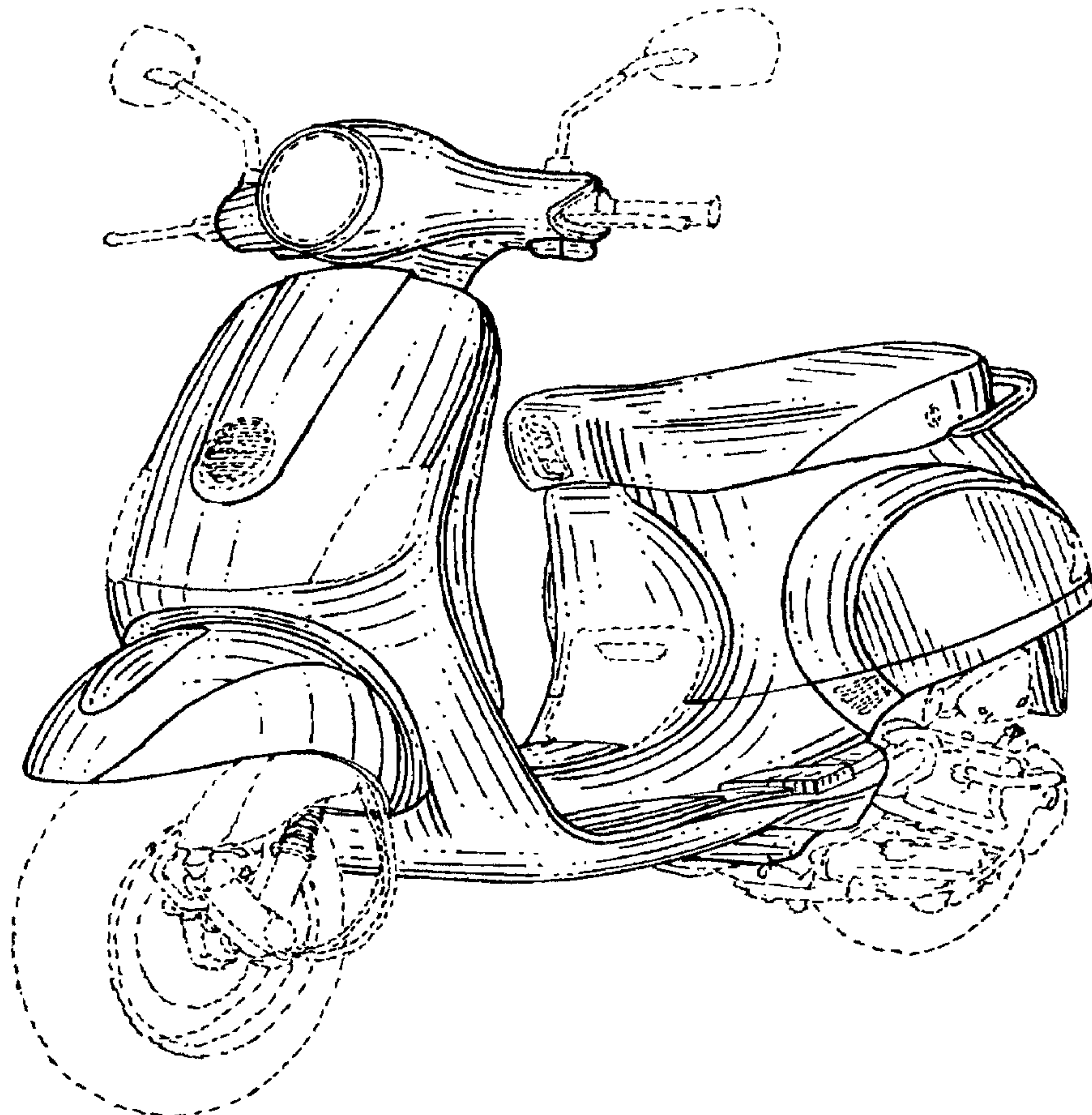

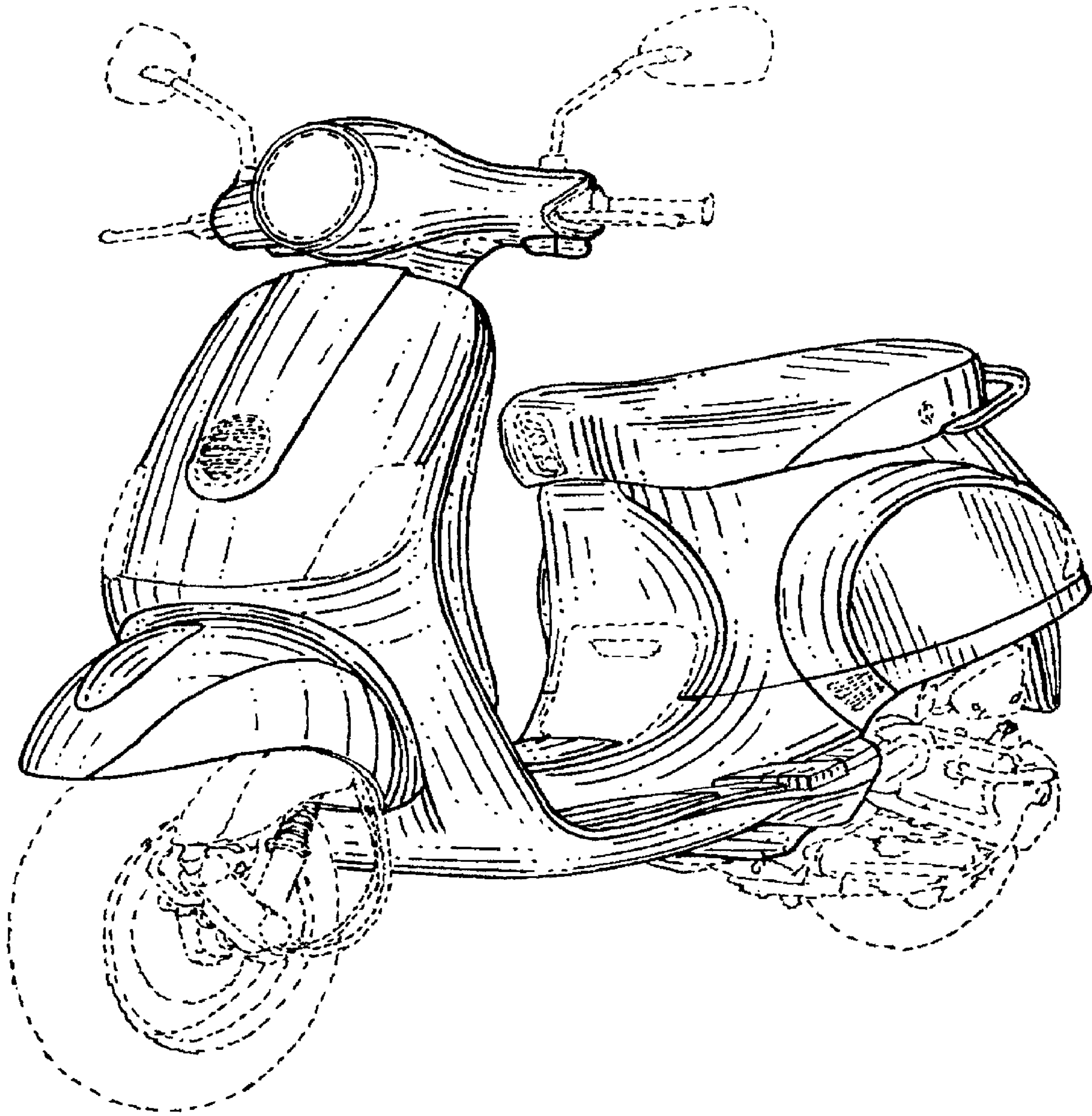

FIG. 1

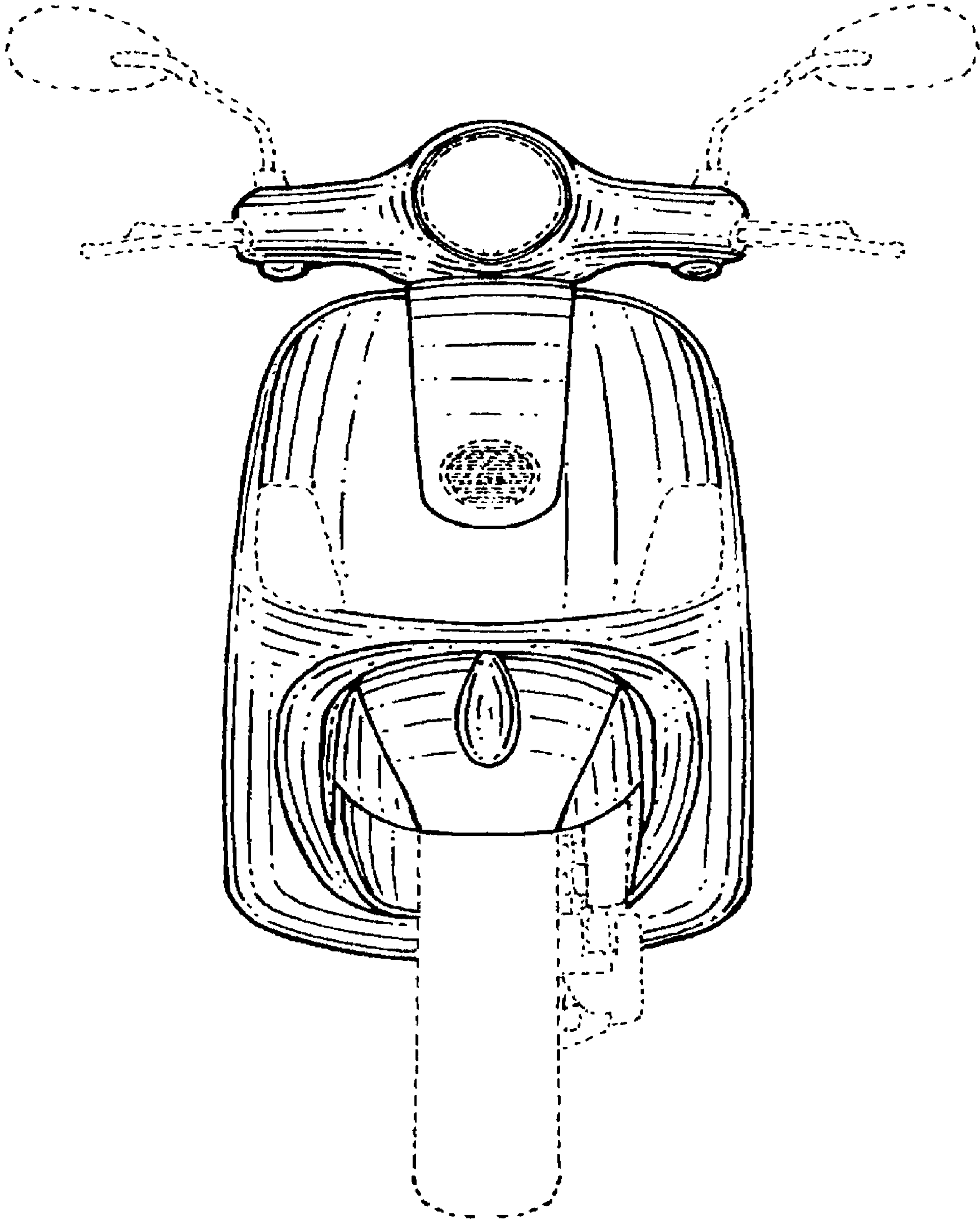

FIG. 2

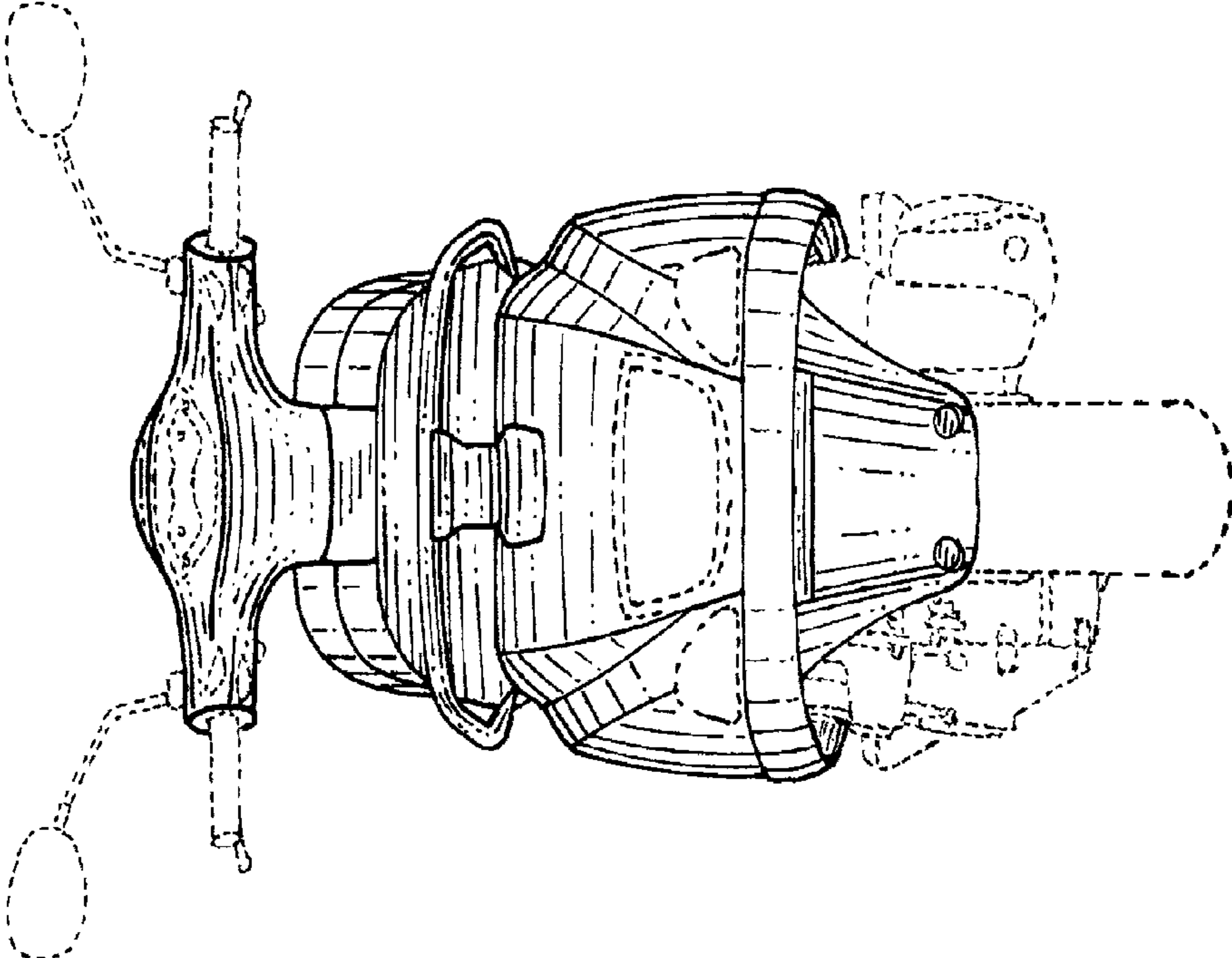
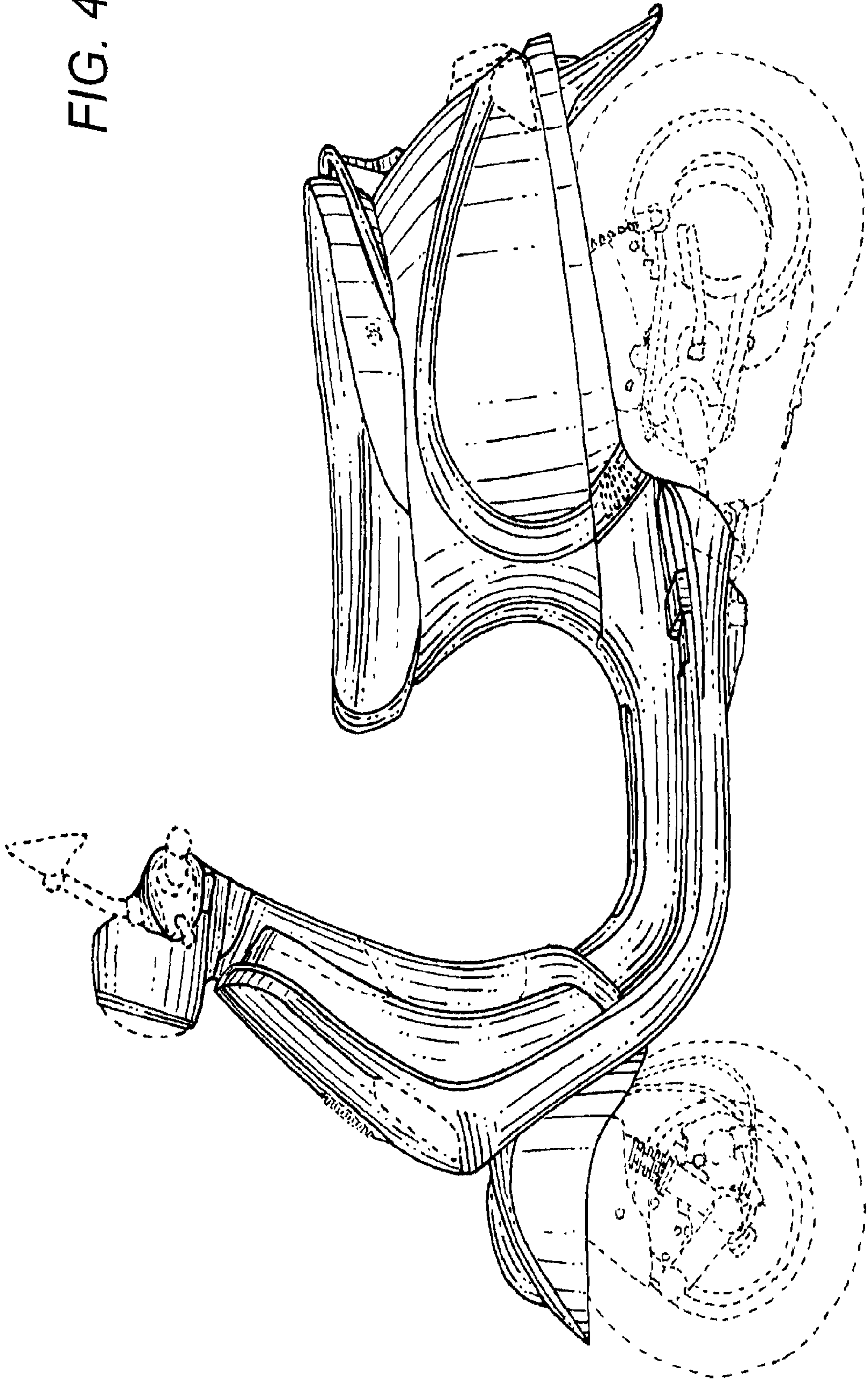

FIG. 3

FIG. 4



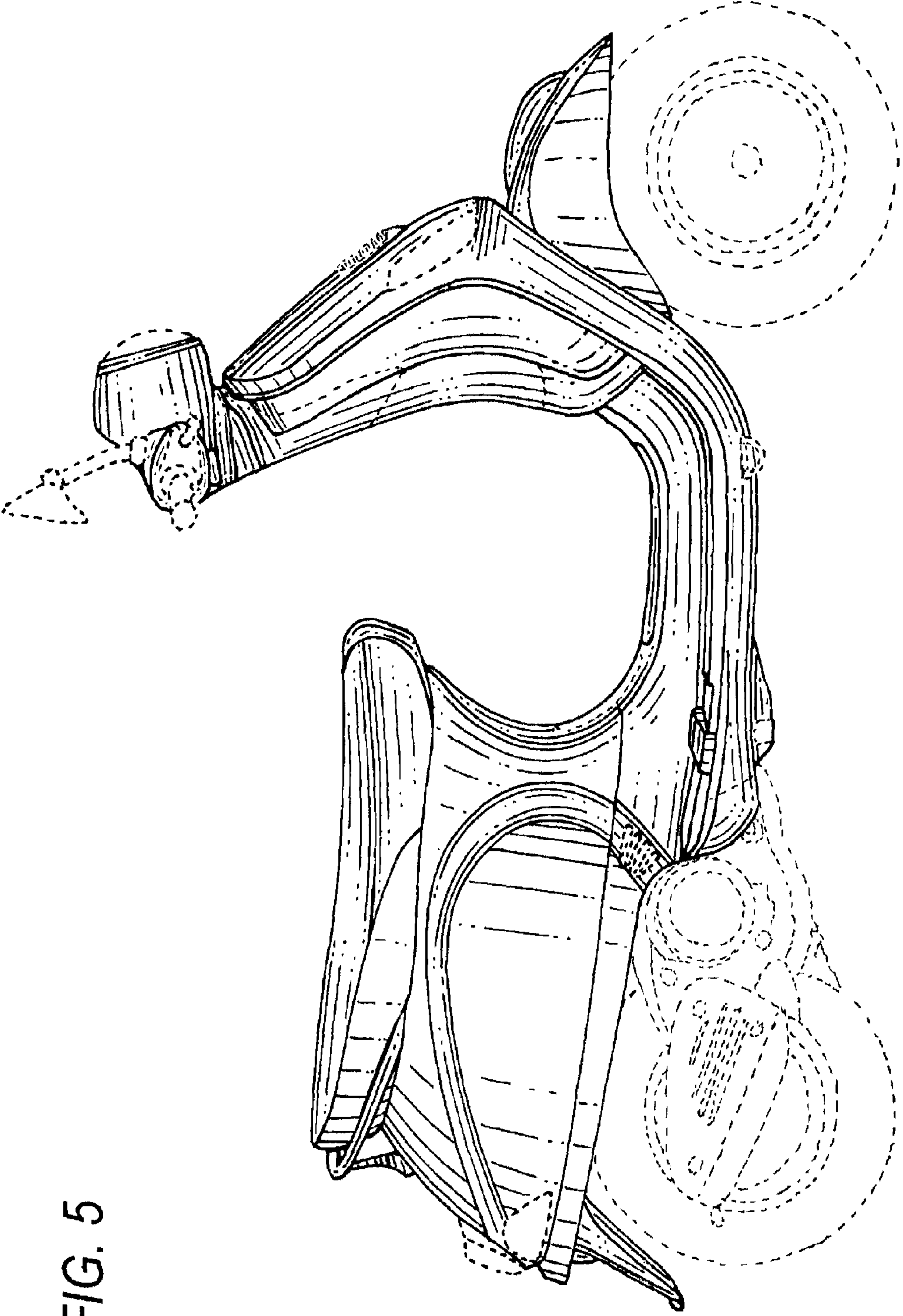

FIG. 5

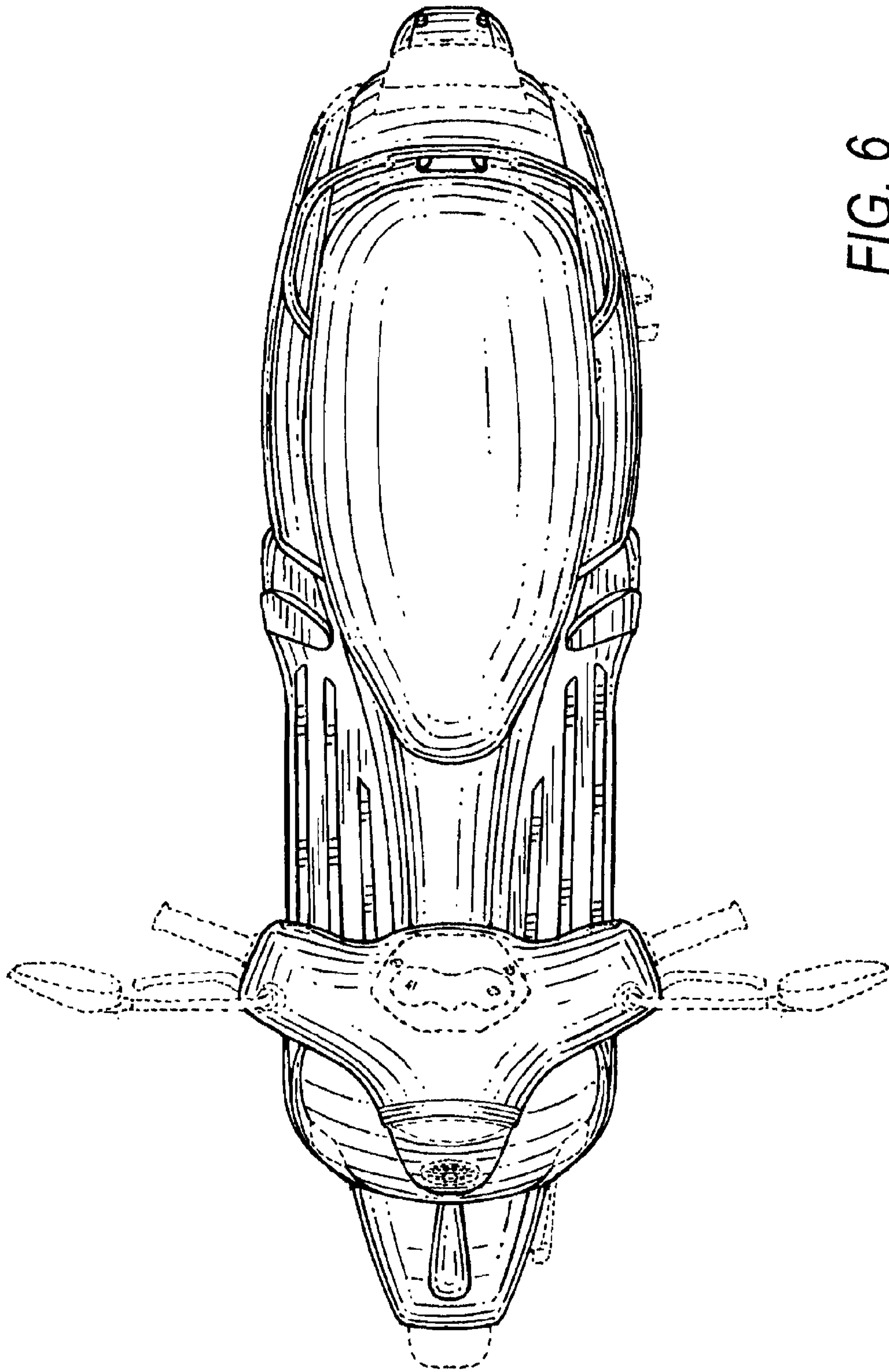

FIG. 6

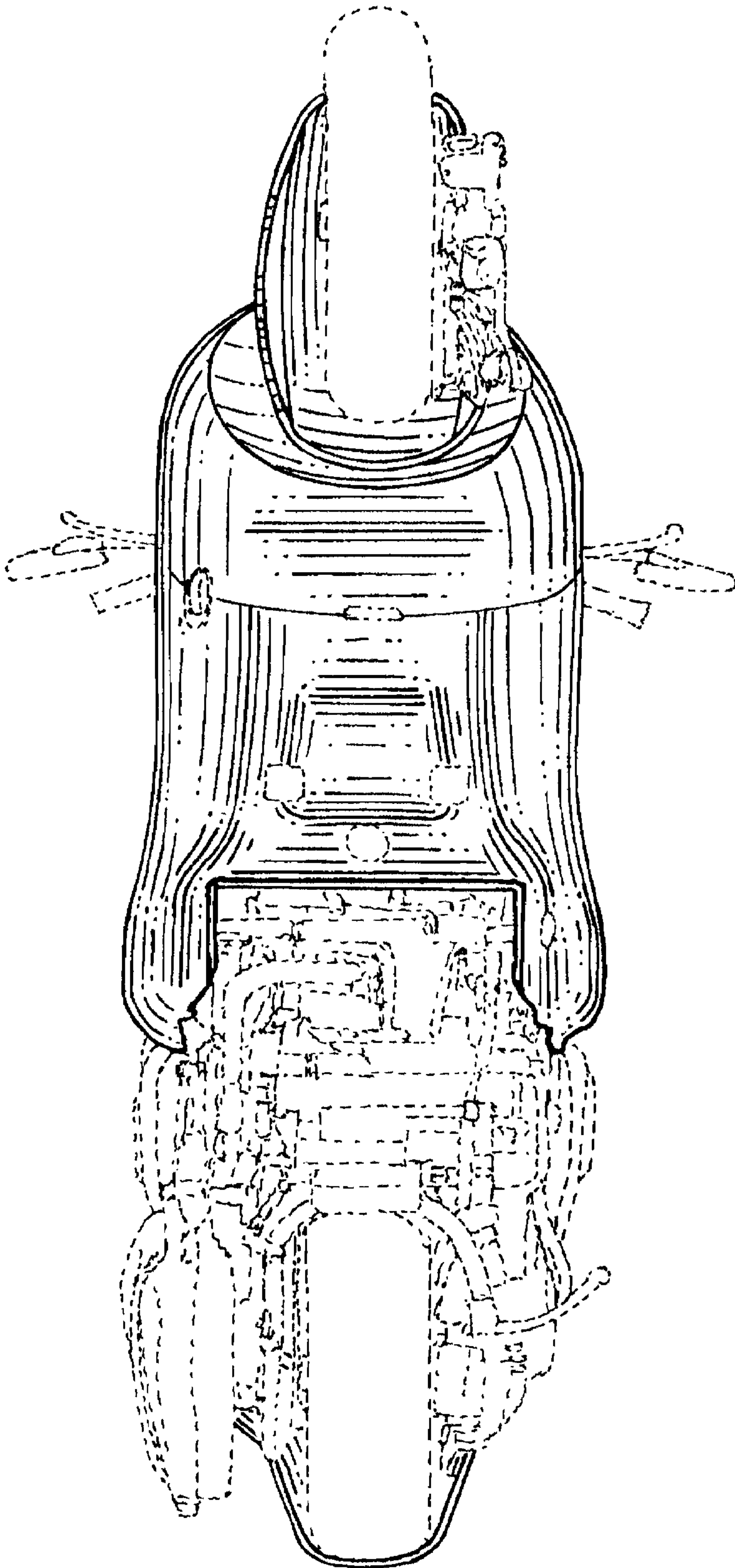

FIG. 7