



US00D657676S

(12) **United States Design Patent**
Ocampo

(10) **Patent No.:** **US D657,676 S**
(45) **Date of Patent:** **** Apr. 17, 2012**

- (54) **SHAVING RAZOR PACKAGE**
- (75) Inventor: **Andres Felipe Ocampo**, Waltham, MA (US)
- (73) Assignee: **The Gillette Company**, Boston, MA (US)
- (**) Term: **14 Years**
- (21) Appl. No.: **29/404,319**
- (22) Filed: **Oct. 19, 2011**

Related U.S. Application Data

- (62) Division of application No. 29/387,316, filed on Mar. 11, 2011, now Pat. No. Des. 649,886.
- (51) **LOC (9) Cl.** **09-03**
- (52) **U.S. Cl.** **D9/457**
- (58) **Field of Classification Search** D9/749, D9/737, 748, 415, 424, 425, 416, 457, 433; D6/526, 512; D3/201, 205; 206/349, 228, 206/244, 252, 775, 208, 493, 354-360, 352; 30/514

See application file for complete search history.

(56) **References Cited**

U.S. PATENT DOCUMENTS

2,229,427 A	1/1941	Tanner
D194,378 S	1/1963	Brower
D219,431 S	12/1970	Hill et al.
D226,754 S	4/1973	Glaberson
D227,859 S	7/1973	Poisson
D228,629 S	10/1973	Glaberson
4,000,832 A	1/1977	Pentney
4,140,244 A	2/1979	Clabby
D253,040 S	10/1979	Fournier et al.
D255,327 S	6/1980	Samsing
D257,327 S	10/1980	Samsing
4,266,664 A	5/1981	Dixon et al.
D262,095 S	12/1981	Takahashi
4,322,002 A	3/1982	Iten
D265,056 S	6/1982	Hadtke
4,341,306 A	7/1982	Lightsey
D272,803 S	2/1984	Richards
4,432,452 A	2/1984	Kelly

4,445,610 A	5/1984	Richards	
D275,737 S	10/1984	Carey, Jr. et al.	
D276,793 S	12/1984	Richards	
D276,893 S	12/1984	Richards	
4,496,047 A	1/1985	Gatley	
4,555,030 A	11/1985	Byrne et al.	
D282,242 S	1/1986	Thorpe	
4,601,392 A	7/1986	Althaus	
D285,907 S *	9/1986	Johnson D9/443
4,735,312 A	4/1988	Iten	
4,785,935 A	11/1988	Iten	
D314,984 S *	2/1991	Hass D20/22
D323,069 S	1/1992	Leese	
D323,460 S	1/1992	Ayala et al.	
D336,426 S	6/1993	Fisher	
5,226,534 A	7/1993	Kim	
D351,554 S	10/1994	Kim	
D361,935 S *	9/1995	Johnson D9/434

(Continued)

Primary Examiner — Mark Goodwin

(74) *Attorney, Agent, or Firm* — John M. Lipchitz; Kevin C. Johnson; Steven W. Miller

(57) **CLAIM**

The ornamental design for a shaving razor package, as shown and described.

DESCRIPTION

FIG. 1 is a perspective view of a shaving razor package of the present invention;
 FIG. 2 is a front view thereof;
 FIG. 3 is a rear view thereof;
 FIG. 4 is a right view thereof;
 FIG. 5 is a left view thereof;
 FIG. 6 is a top view thereof;
 FIG. 7 is a bottom view thereof;
 FIG. 8 is a perspective view of a second embodiment of a shaving razor package of the present invention;
 FIG. 9 is a front view thereof;
 FIG. 10 is a rear view thereof;
 FIG. 11 is a right view thereof;
 FIG. 12 is a left view thereof;
 FIG. 13 is a top view thereof; and,
 FIG. 14 is a bottom view thereof.
 The broken line showing in FIGS. 8, 9, and 10 is included for the purpose of illustrating environmental structure only and forms no part of the claimed design.

1 Claim, 4 Drawing Sheets

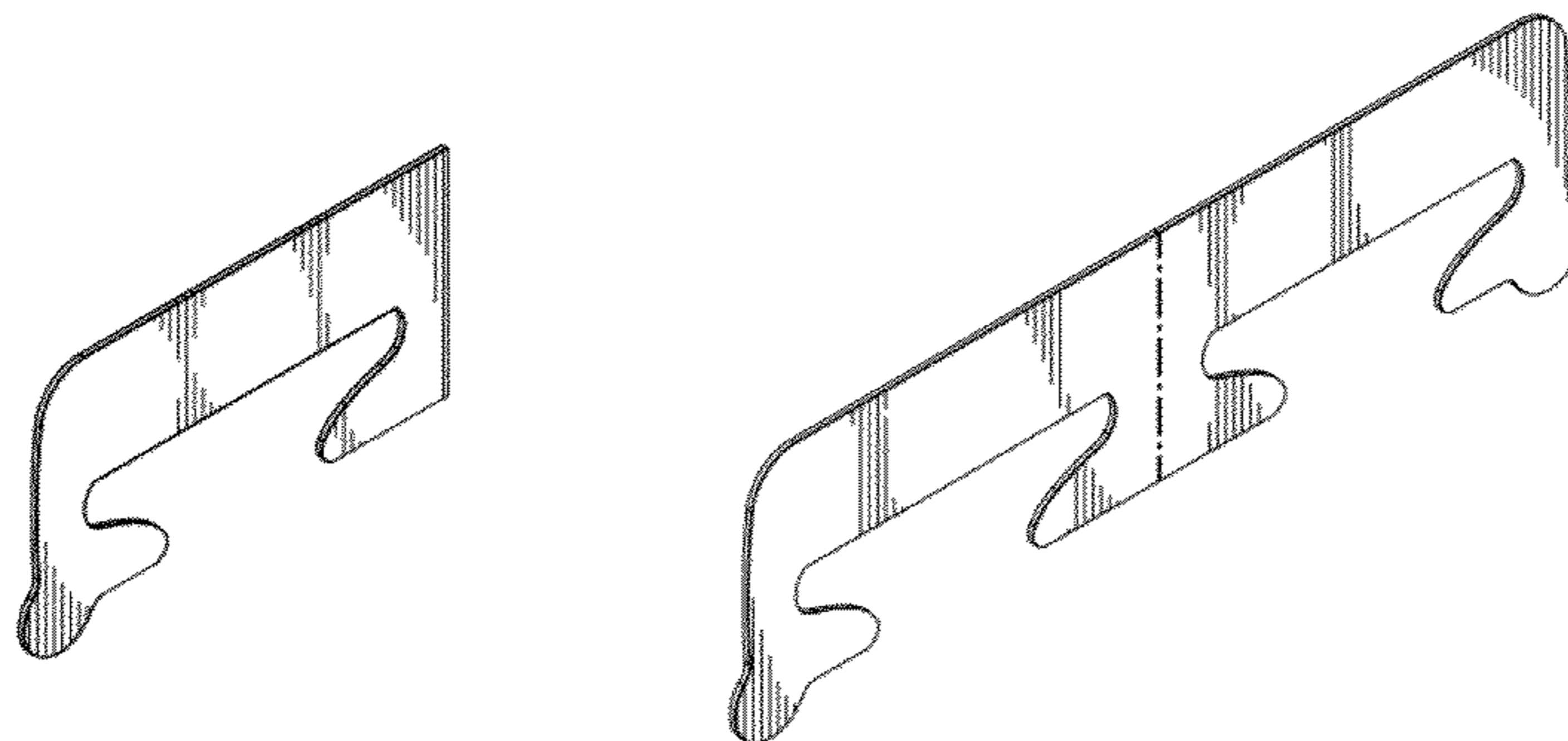

US D657,676 S

Page 2

U.S. PATENT DOCUMENTS

D377,667 S *	1/1997	DeArkland	D20/22	D484,413 S *	12/2003	Koizumi	D9/457
D413,801 S *	9/1999	Bell	D9/415	D493,105 S	7/2004	Childs et al.	
5,988,373 A	11/1999	Yates		D496,267 S	9/2004	Tommasetti	
D427,640 S	7/2000	Derentz		D520,185 S	5/2006	Zeng et al.	
D432,010 S *	10/2000	Etzel	D9/415	D558,063 S	12/2007	Kohring	
6,276,529 B1	8/2001	Feehan		D561,610 S	2/2008	Renaldi et al.	
D449,992 S	11/2001	Blackburn		D574,229 S	8/2008	Terrasi	
D450,240 S	11/2001	Haag et al.		D579,347 S	10/2008	Kohring	
D453,901 S	2/2002	Shepperson		D595,126 S	6/2009	Marcinkowski	
D461,128 S	8/2002	Kardush		D601,021 S	9/2009	Hogenbirk	
D461,409 S	8/2002	Kardush		D614,023 S	4/2010	Amos et al.	
D472,468 S *	4/2003	Kardush	D9/457	D614,491 S	4/2010	Rhoad	
D478,281 S	8/2003	Prochaska		D620,787 S	8/2010	Moriya	

* cited by examiner

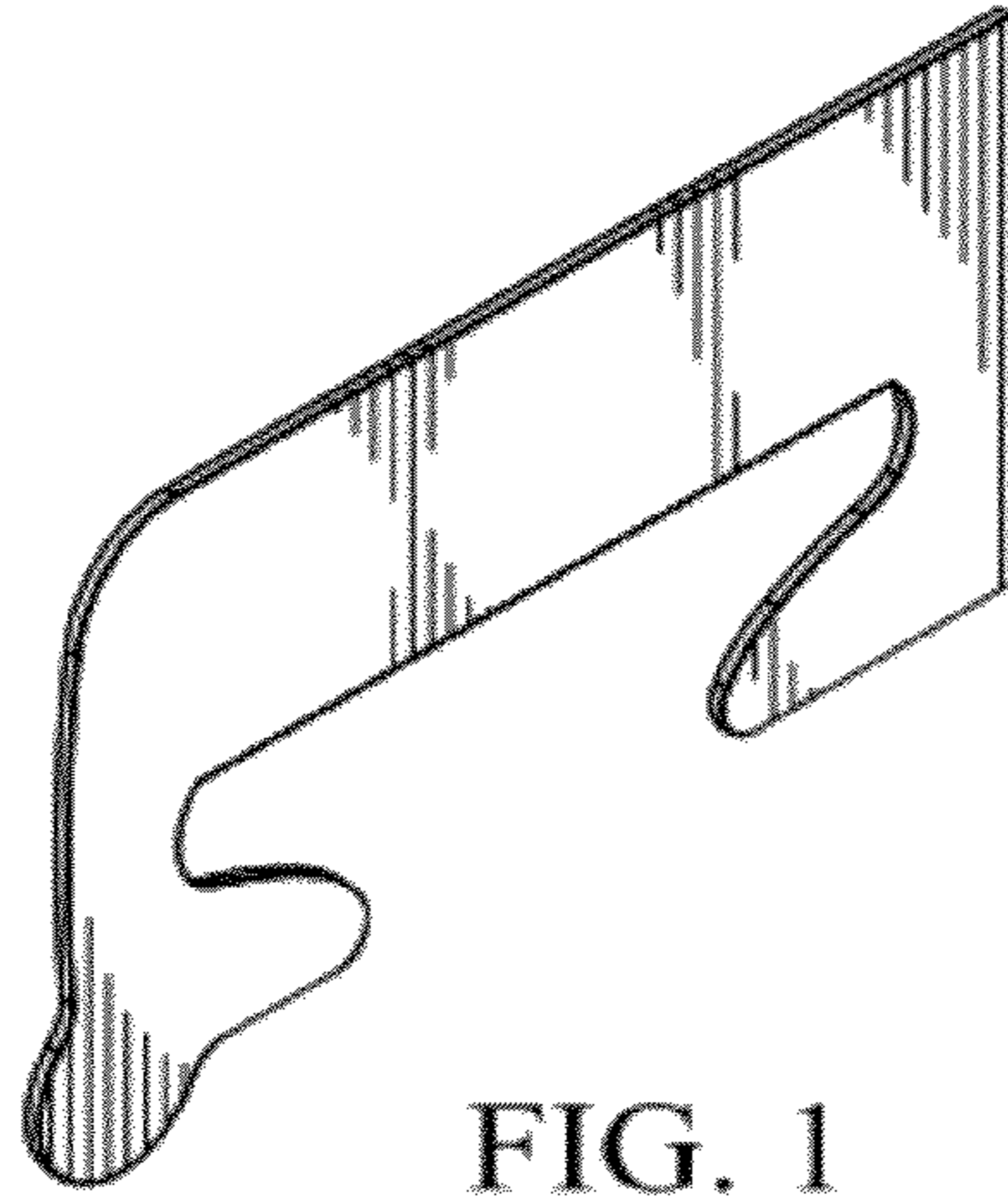

FIG. 1

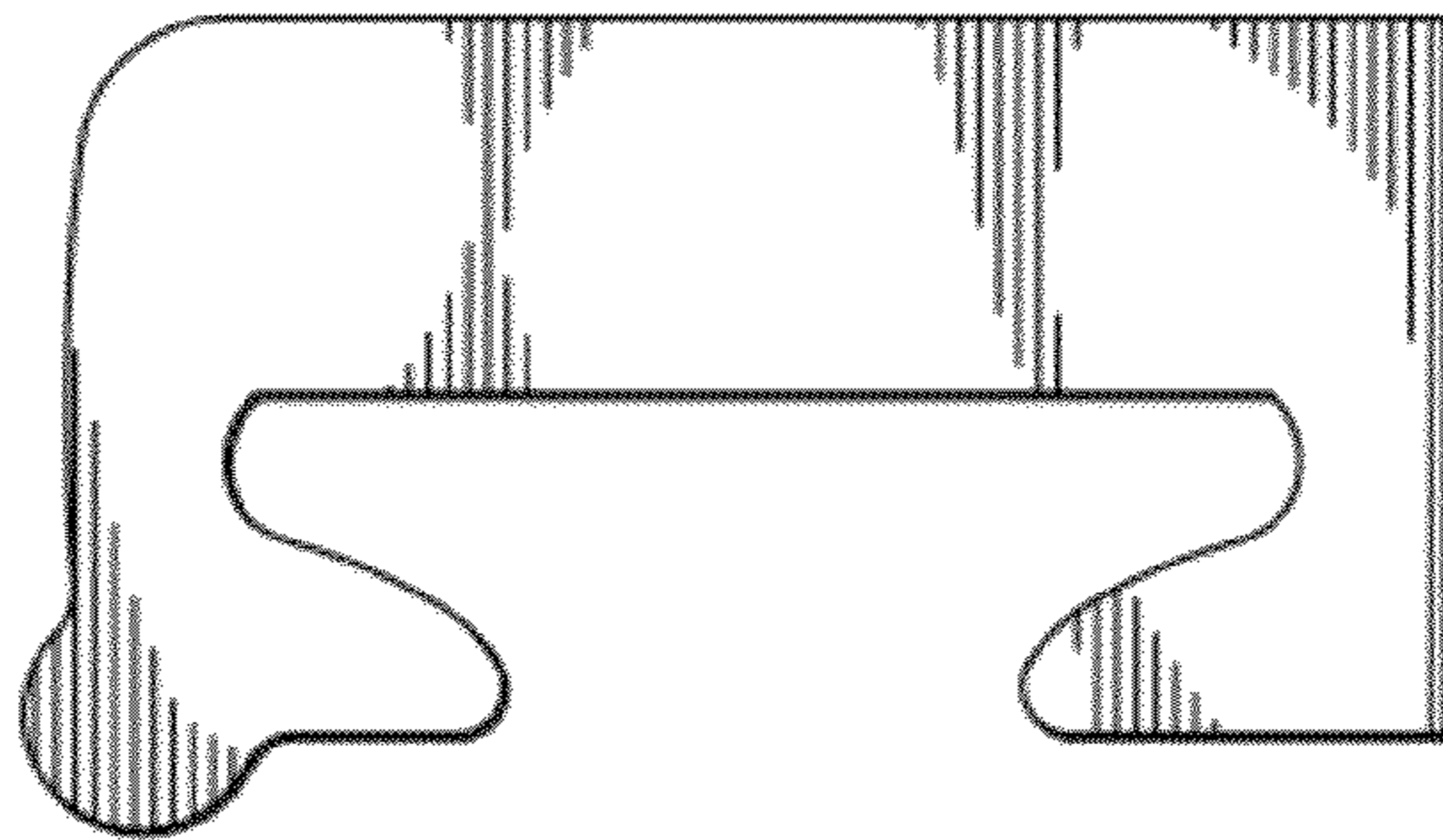

FIG. 2

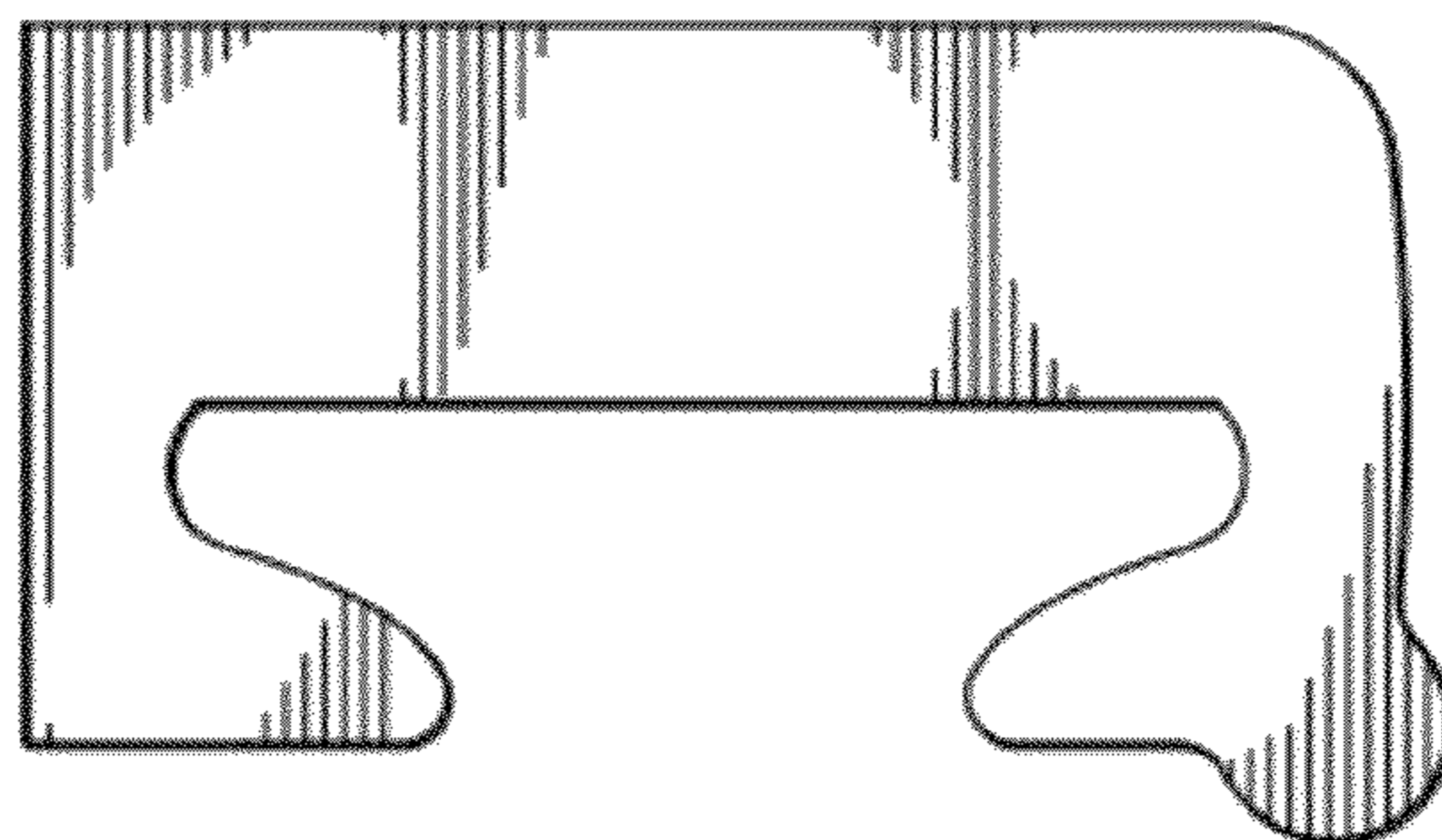

FIG. 3



FIG. 4



FIG. 5

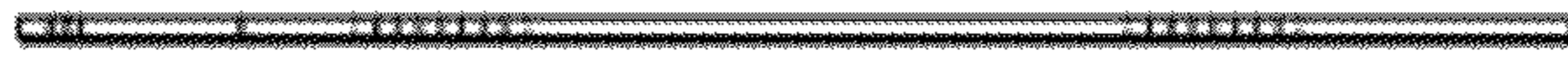

FIG. 6



FIG. 7

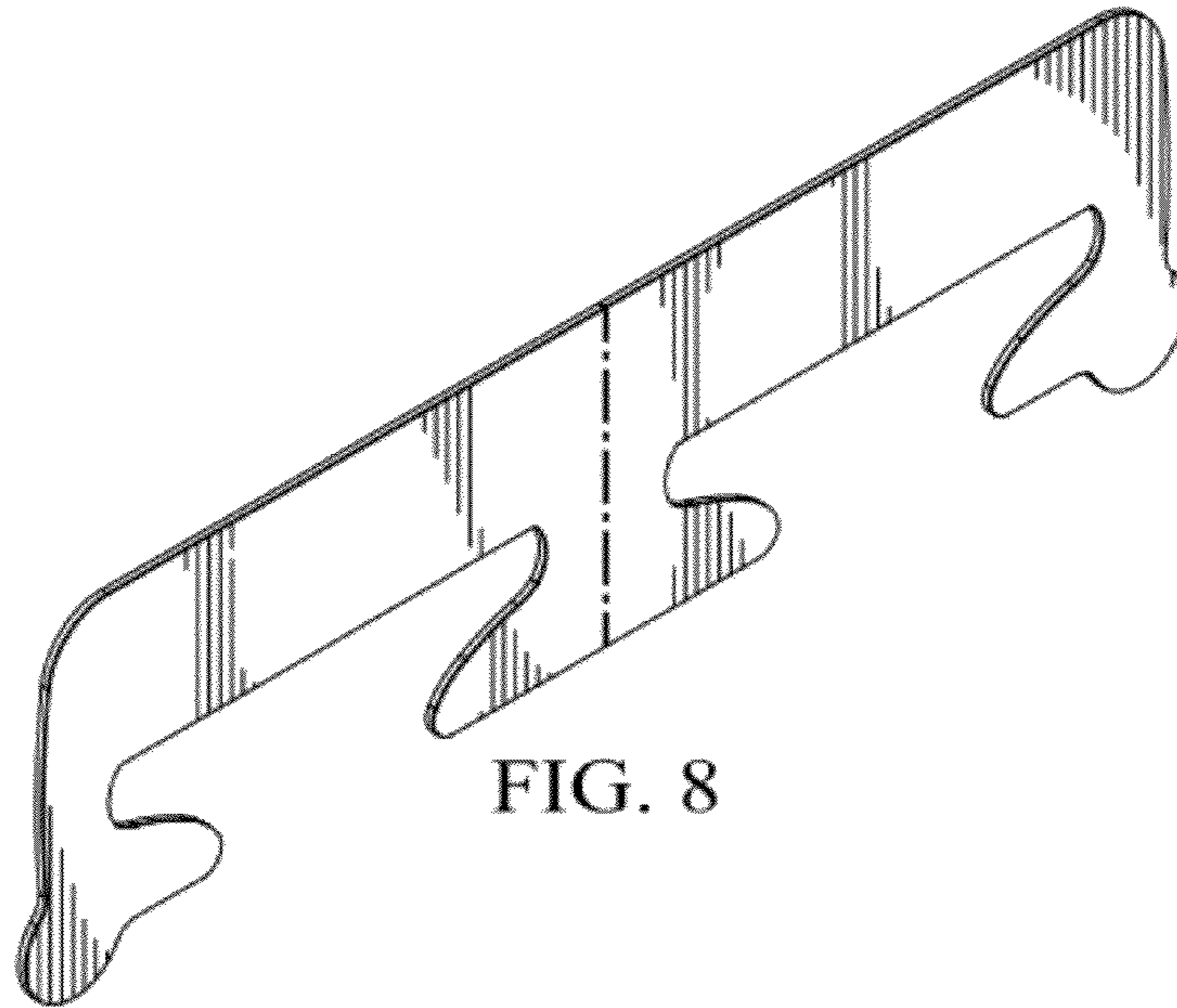

FIG. 8

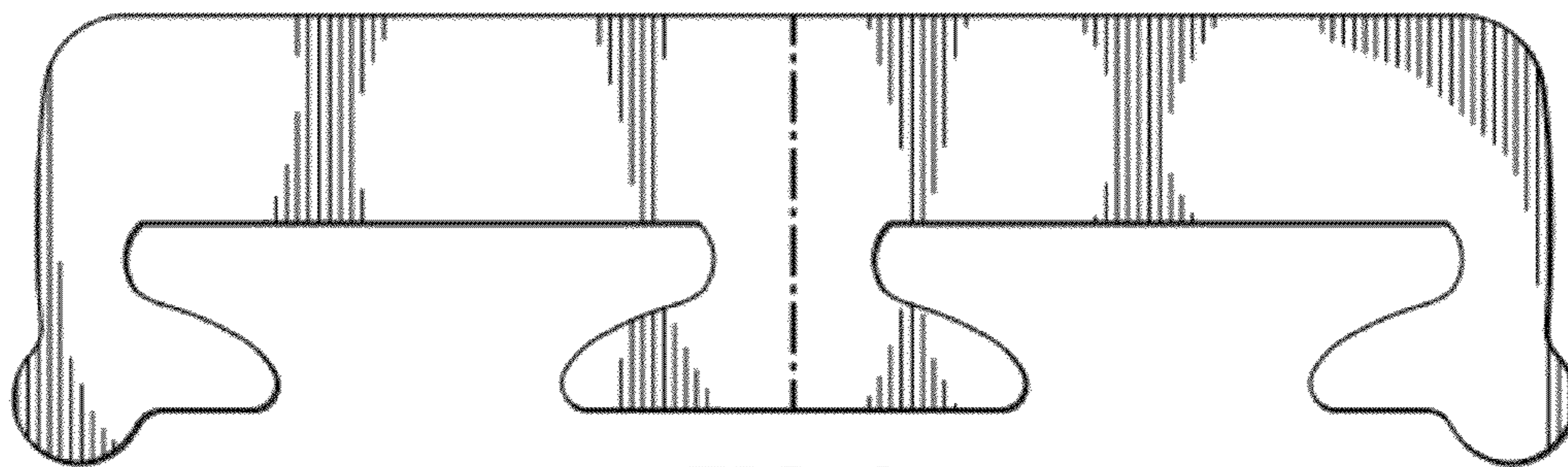

FIG. 9

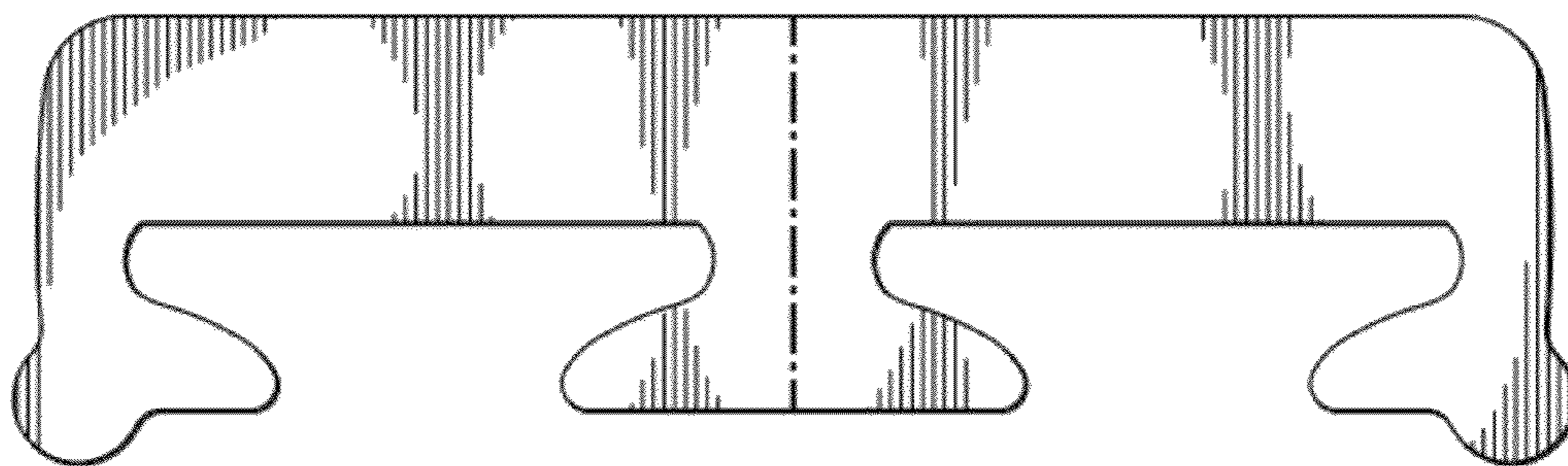

FIG. 10



FIG. 11



FIG. 12



FIG. 13



FIG. 14