



US00D657671S

(12) **United States Design Patent**
O'Brien

(10) **Patent No.:** **US D657,671 S**

(45) **Date of Patent:** **** Apr. 17, 2012**

(54) **STRAINER OVERCAP**

Primary Examiner — Susan Bennett Hattan

(75) Inventor: **Kirsten O'Brien**, Walnut Creek, CA
(US)

(74) *Attorney, Agent, or Firm* — Chadbourne & Parke LLP

(73) Assignee: **Del Monte Corporation**, San Francisco,
CA (US)

(57) **CLAIM**

The ornamental design for a strainer overcap, substantially as shown and described.

(**) Term: **14 Years**

(21) Appl. No.: **29/382,979**

(22) Filed: **Jan. 10, 2011**

DESCRIPTION

(51) **LOC (9) Cl.** **09-07**

(52) **U.S. Cl.** **D9/447; D9/454; D9/436**

(58) **Field of Classification Search** D9/772,
D9/454, 450, 449, 447, 438, 436, 435, 434;
D7/396.2, 392.1; 220/713, 711, 703, 377,
220/273, 270, 256.1, 254.1

See application file for complete search history.

FIG. 1 is a perspective view of a strainer overcap showing the new design, illustrating a front, top and one side view;

FIG. 2 is the perspective view illustrating a front, top and one side view;

FIG. 3 is the perspective view illustrating a bottom view;

FIG. 4 is the perspective view illustrating a bottom and side view;

FIG. 5 is the perspective view illustrating the front, top and one side view;

FIG. 6 is a second perspective view of a strainer overcap showing the new design, illustrating a front, top and one side view;

FIG. 7 is the perspective view illustrating a bottom and one side view;

FIG. 8 is the perspective view illustrating the bottom view;

FIG. 9 is the perspective view illustrating the bottom and side view;

FIG. 10 is the perspective view illustrating the front, top and one side view;

FIG. 11 is a third perspective view of a strainer overcap showing a bottom and one side view;

FIG. 12 is the perspective view illustrating the bottom view;

FIG. 13 is the perspective view illustrating the bottom and side view; and,

FIG. 14 is the perspective view illustrating the side view.

The broken lines in the Figures illustrate the environment of the strainer overcap which form no part of the claimed design.

(56) **References Cited**

U.S. PATENT DOCUMENTS

3,265,255	A *	8/1966	Mitchell	222/425
D239,600	S *	4/1976	Newman	D9/447
D239,601	S *	4/1976	Newman	D9/447
D239,602	S *	4/1976	Newman	D9/447
D239,603	S *	4/1976	Newman	D9/447
D239,606	S *	4/1976	Newman	D9/447
D240,020	S *	5/1976	Newman	D9/447
D240,403	S *	7/1976	Newman	D9/447
D240,601	S *	7/1976	Newman	D9/447
D240,602	S *	7/1976	Newman	D9/447
D242,129	S *	11/1976	Hasegawa et al.	D9/447
D242,130	S *	11/1976	Hasegawa	D9/447
D242,131	S *	11/1976	Hasegawa	D9/447
D242,132	S *	11/1976	Hasegawa	D9/447
D247,475	S *	3/1978	Newman	D9/447
D253,338	S *	11/1979	Hasegawa	D9/440
4,331,255	A *	5/1982	Fournier	220/257.2
4,938,379	A *	7/1990	Kellner	220/370
D317,411	S *	6/1991	Holmes	D9/435
D573,879	S *	7/2008	Kett	D9/447

* cited by examiner

1 Claim, 14 Drawing Sheets

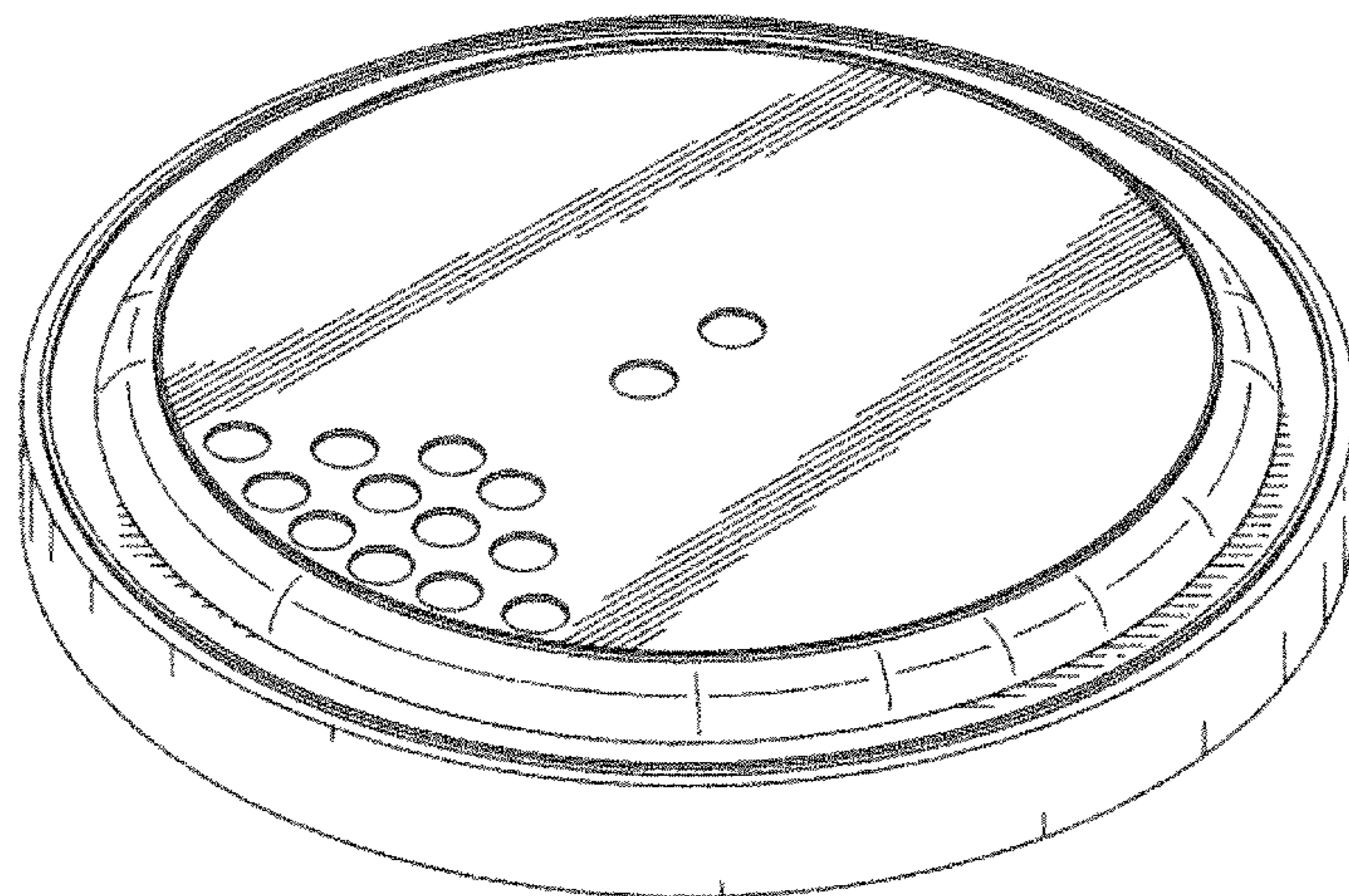

FIG. 1

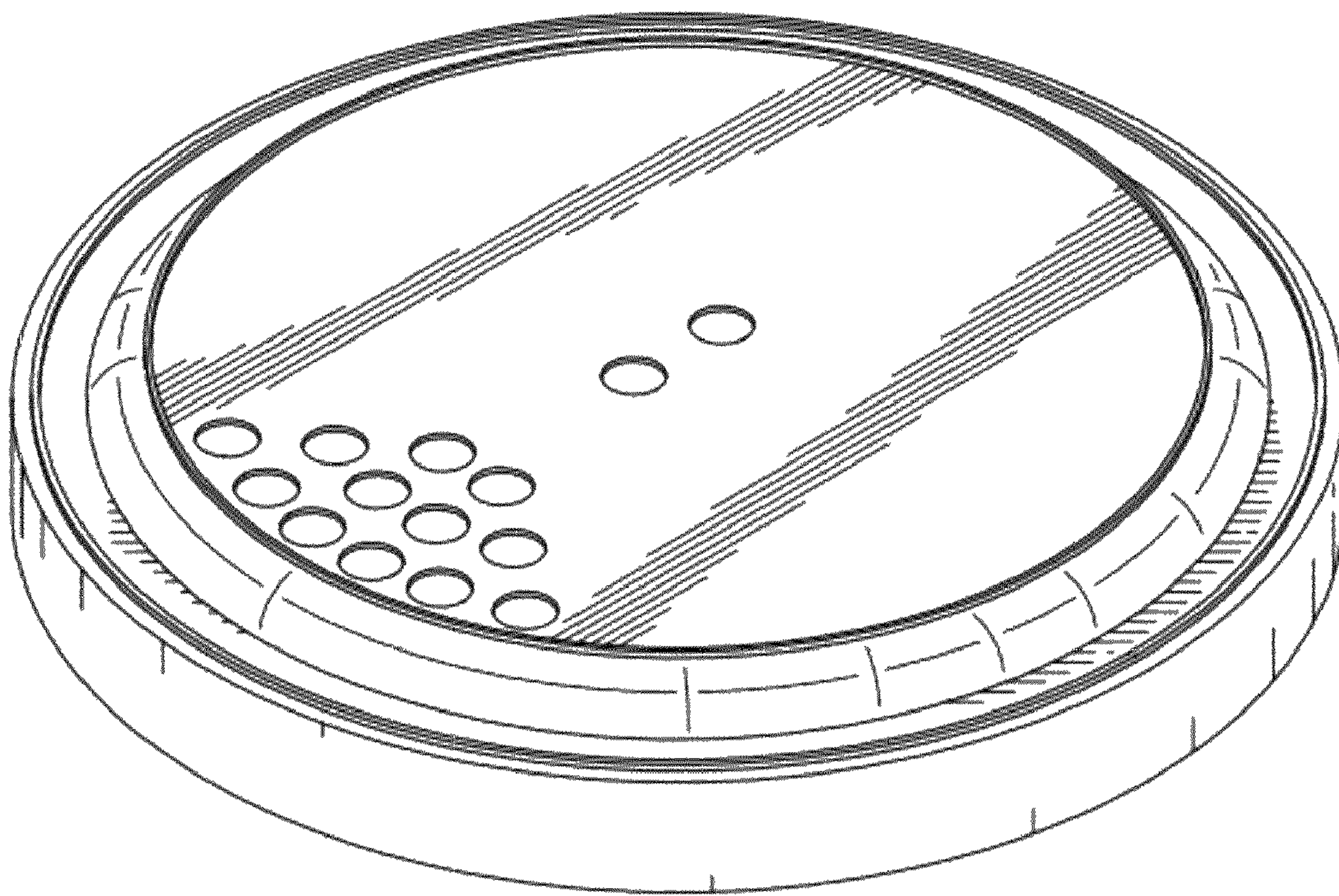

FIG. 2

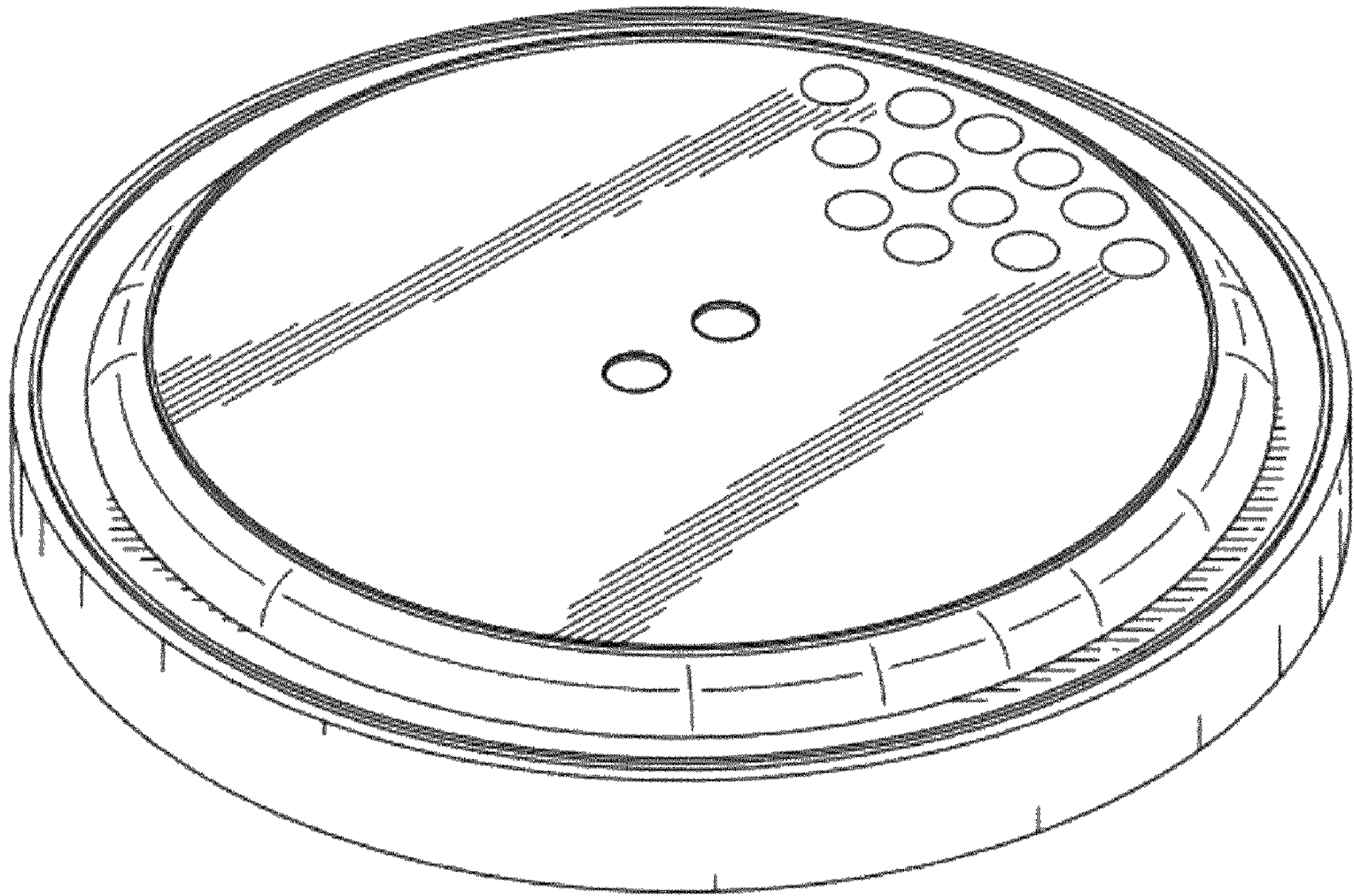

FIG. 3

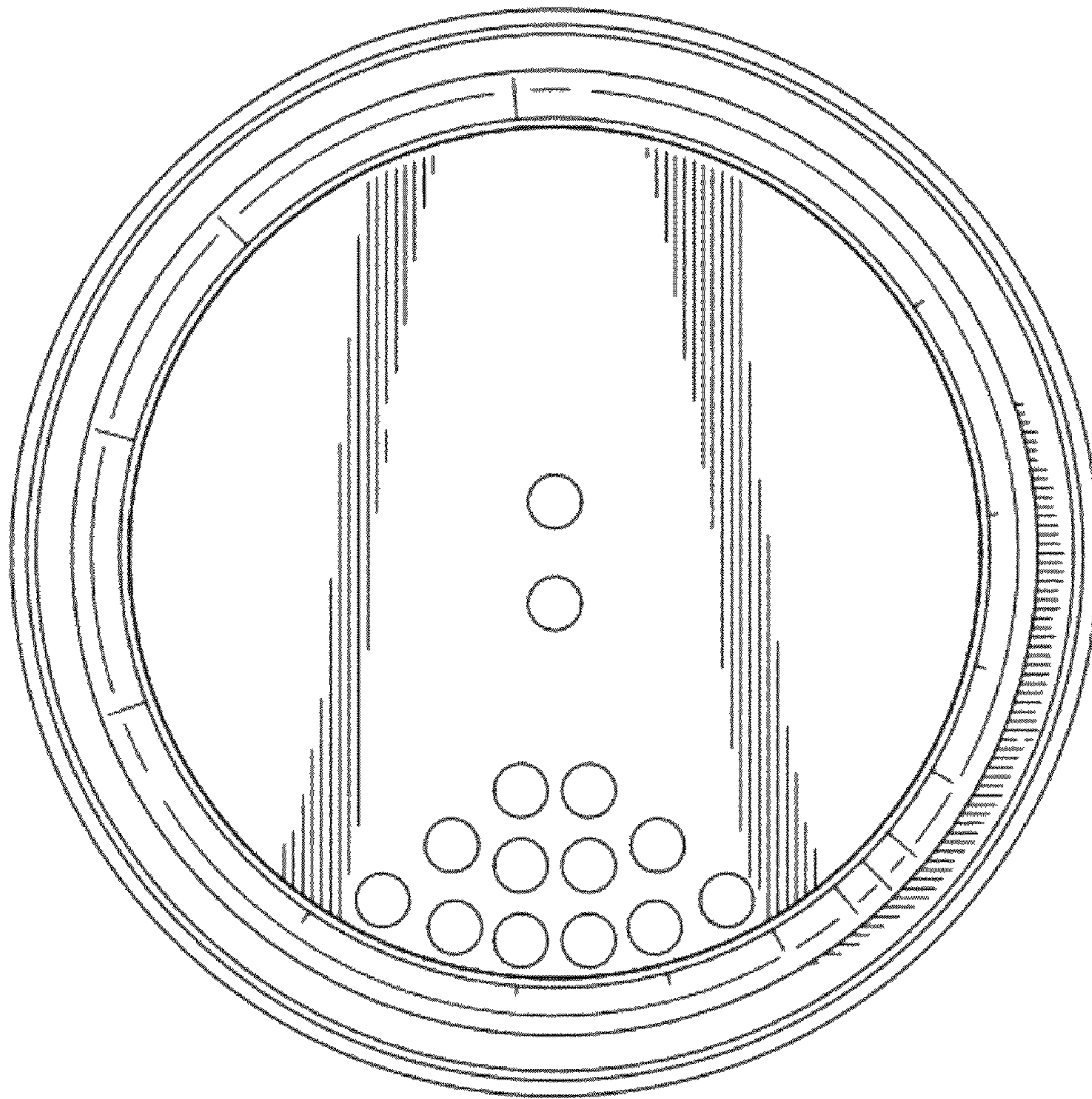

FIG. 4

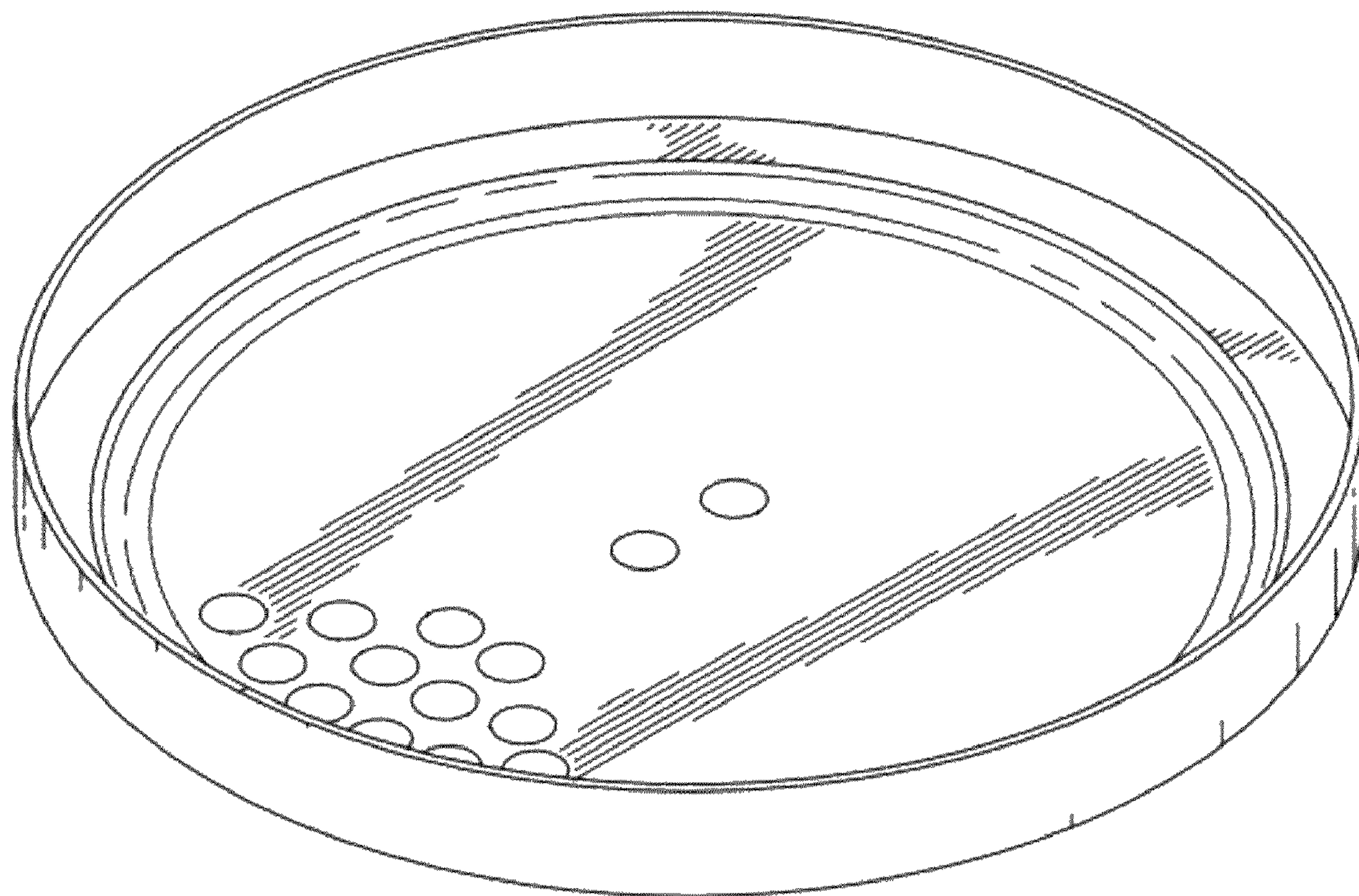

FIG. 5

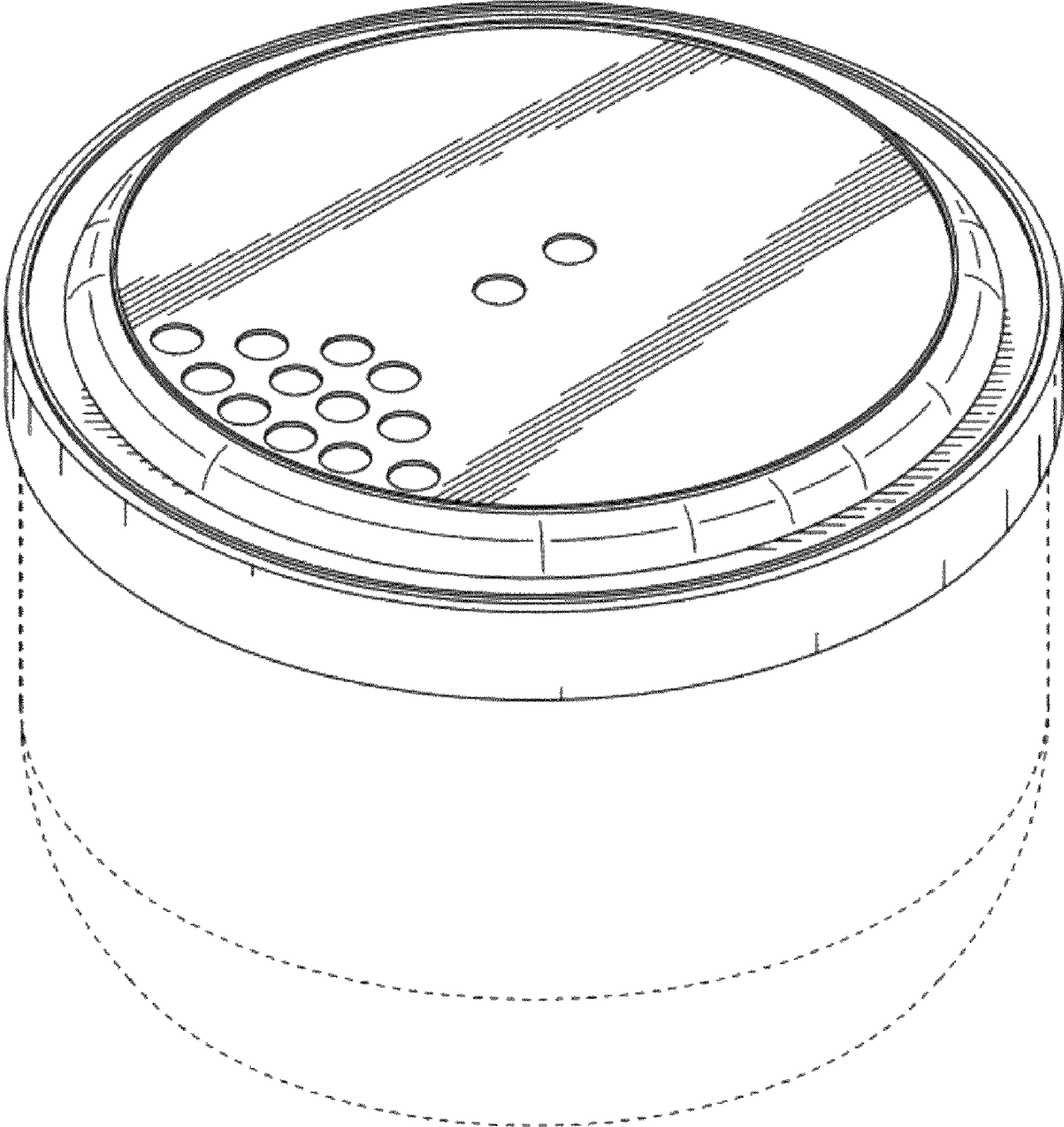

FIG. 6

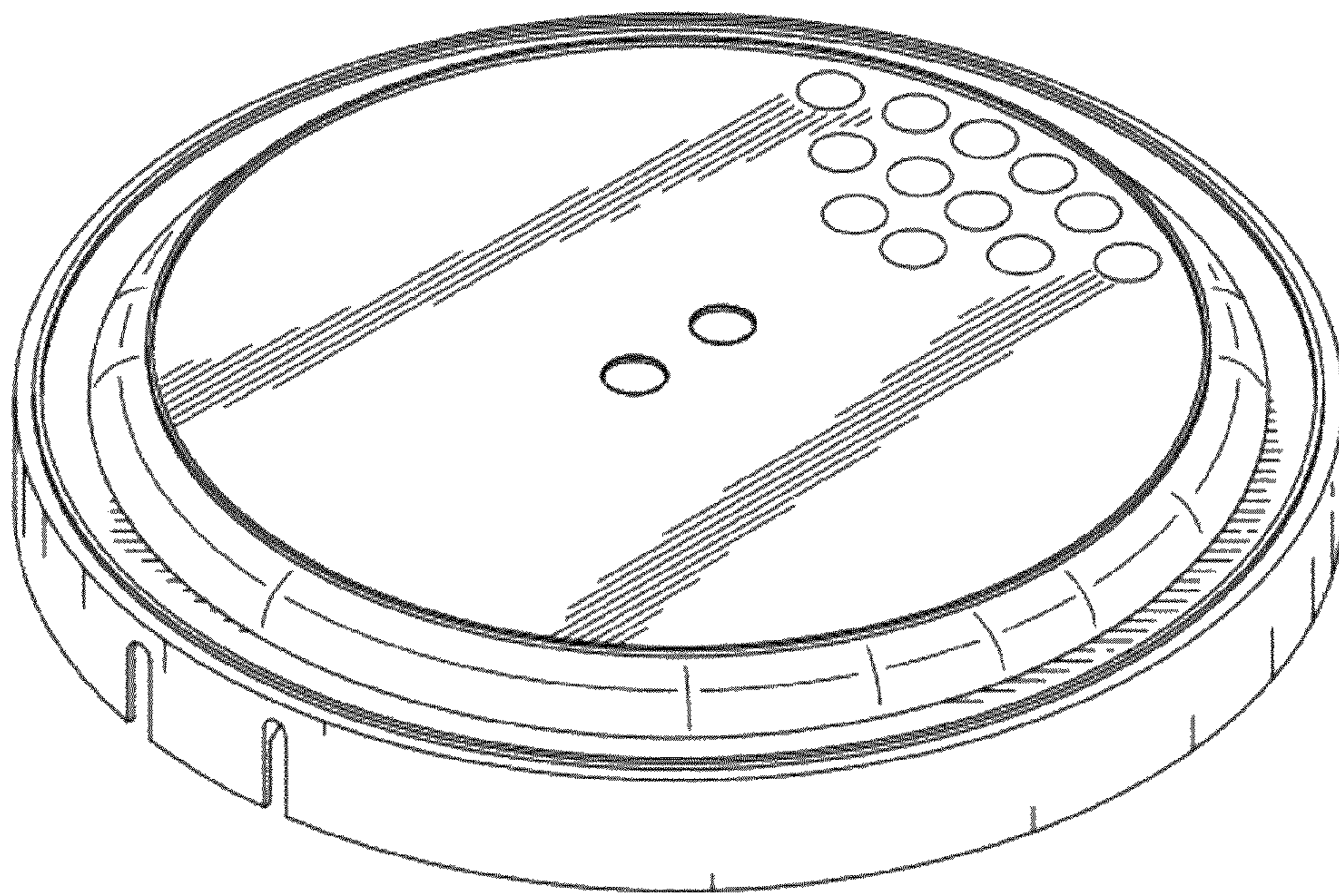

FIG. 7

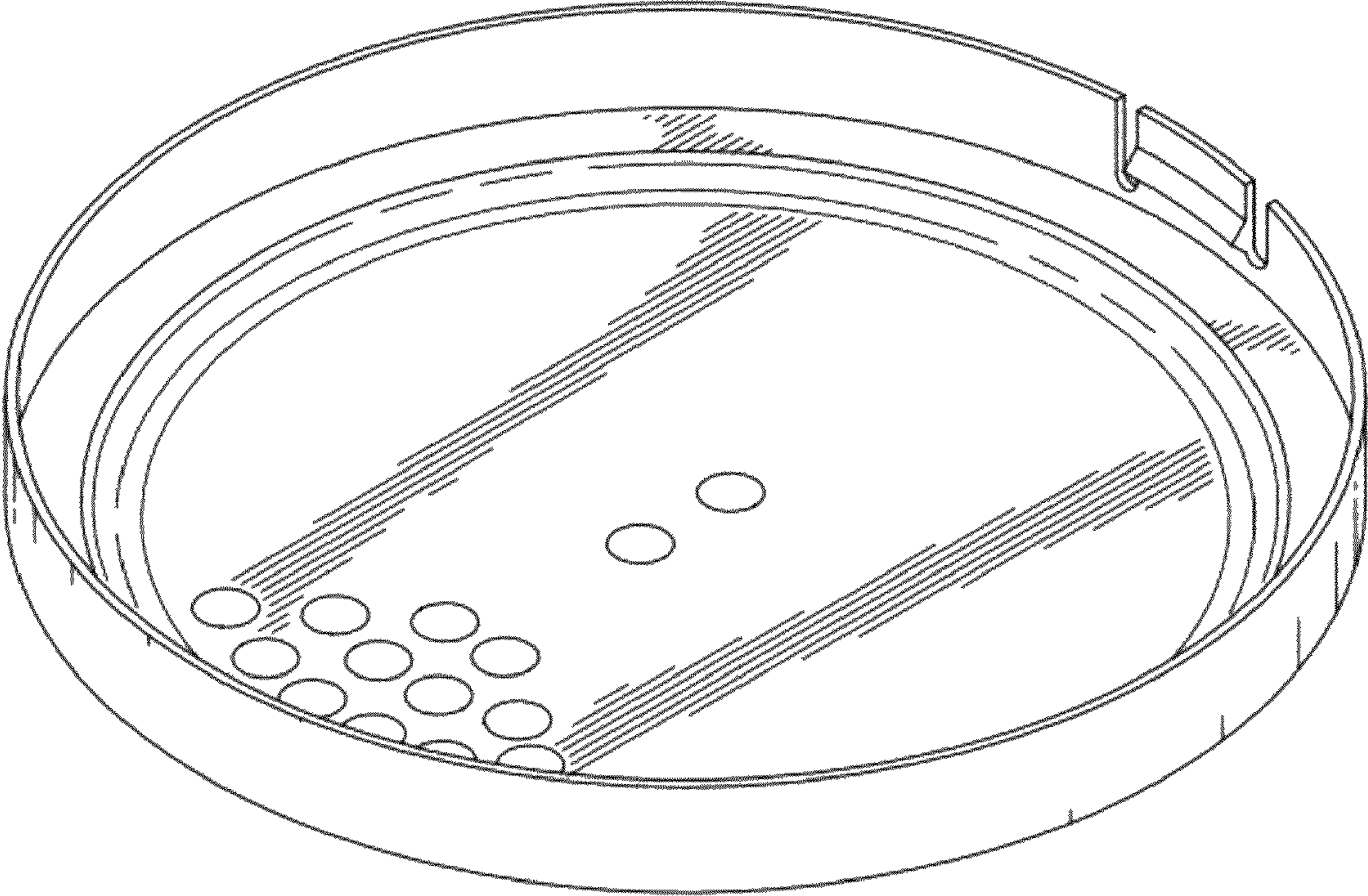

FIG. 8

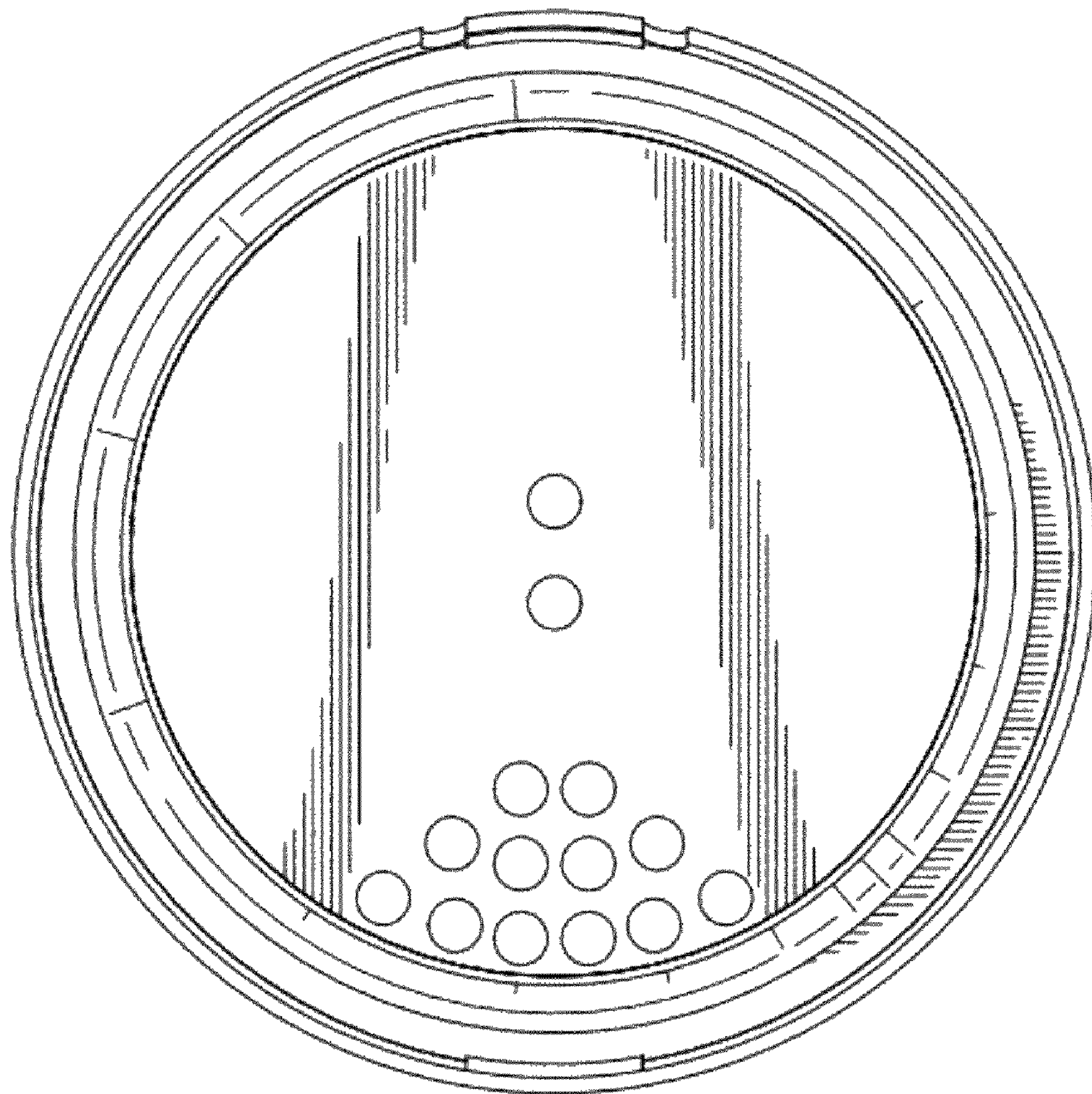

FIG. 9

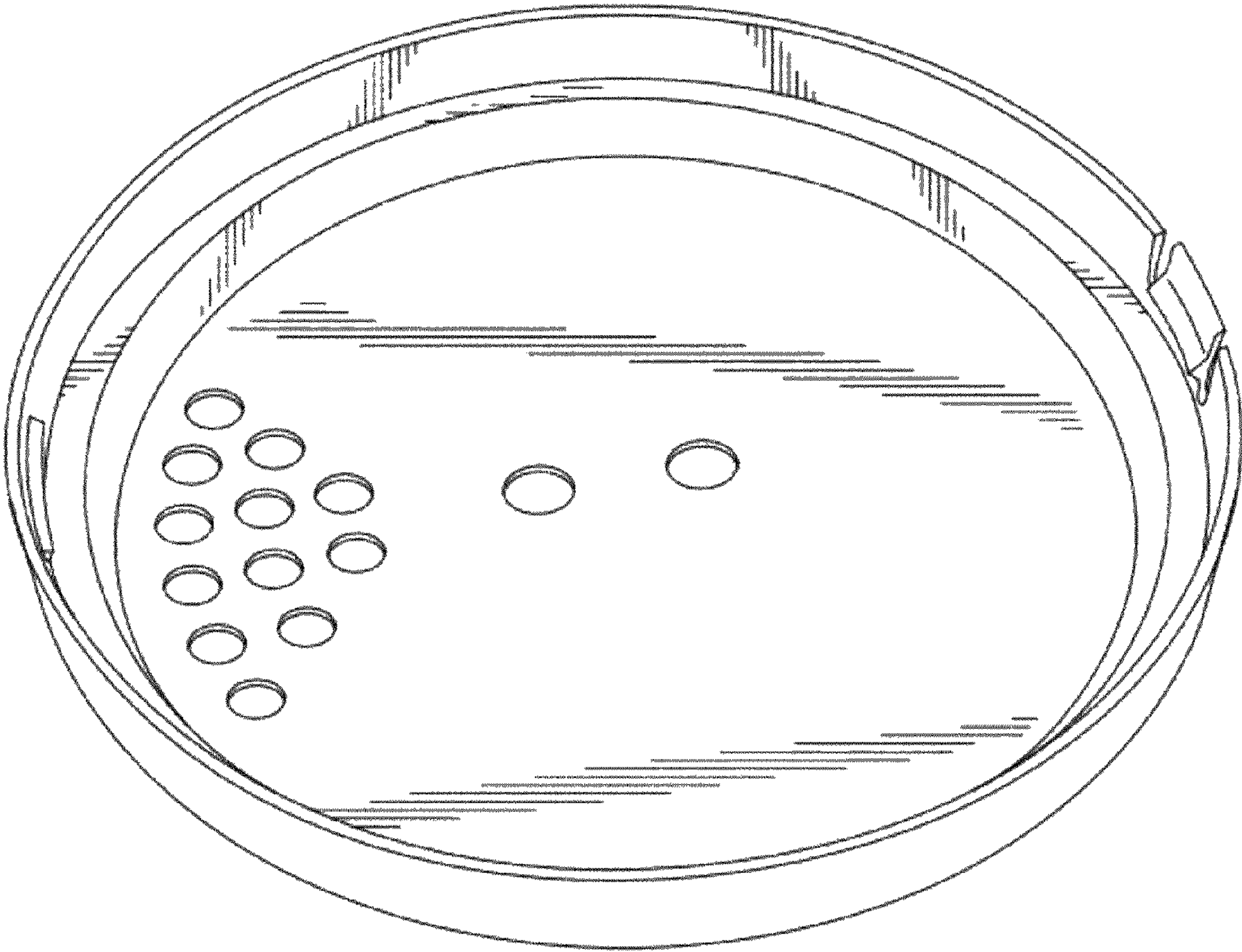

FIG. 10

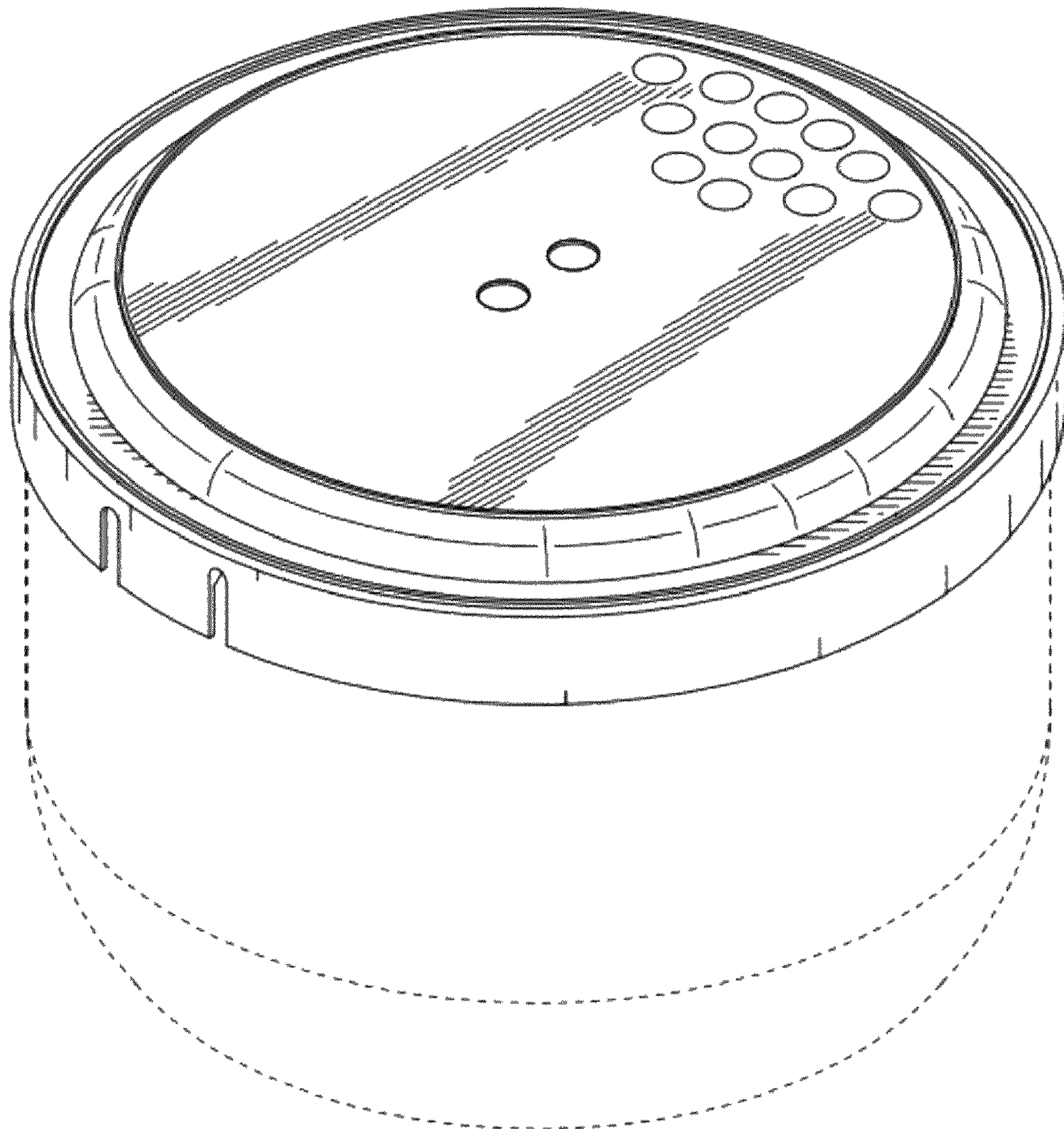

FIG. 11

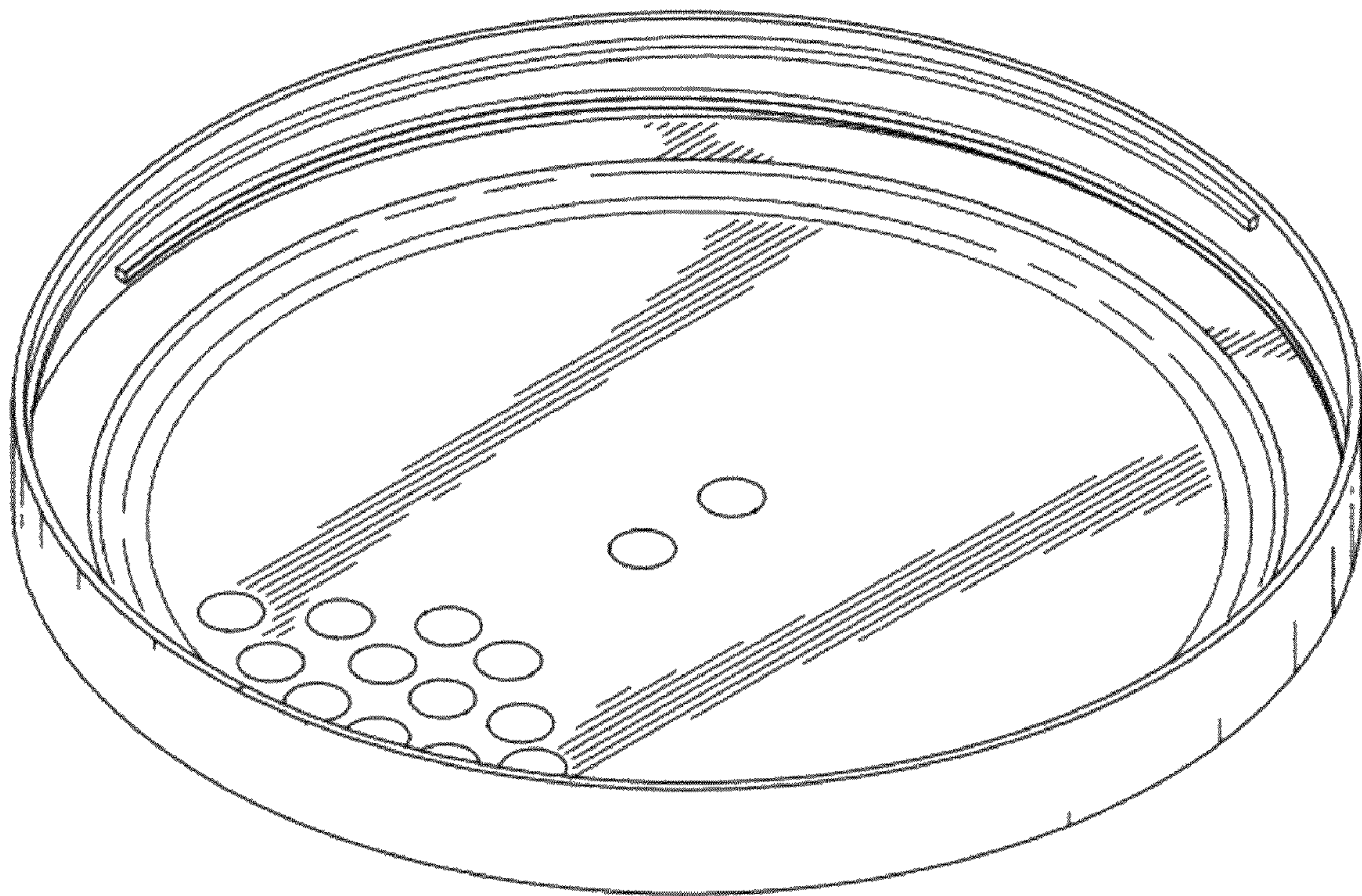

FIG. 12

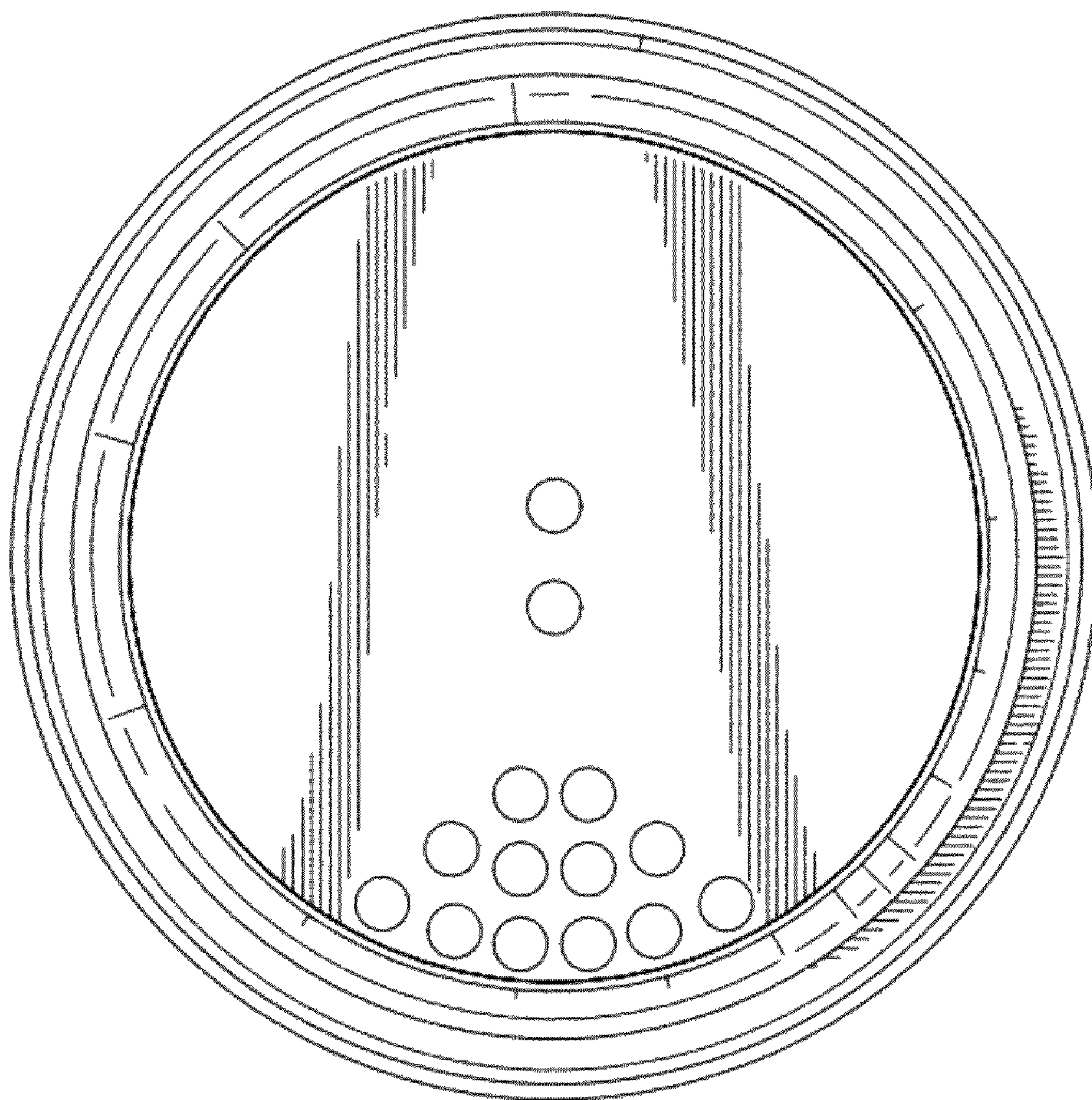

FIG. 13

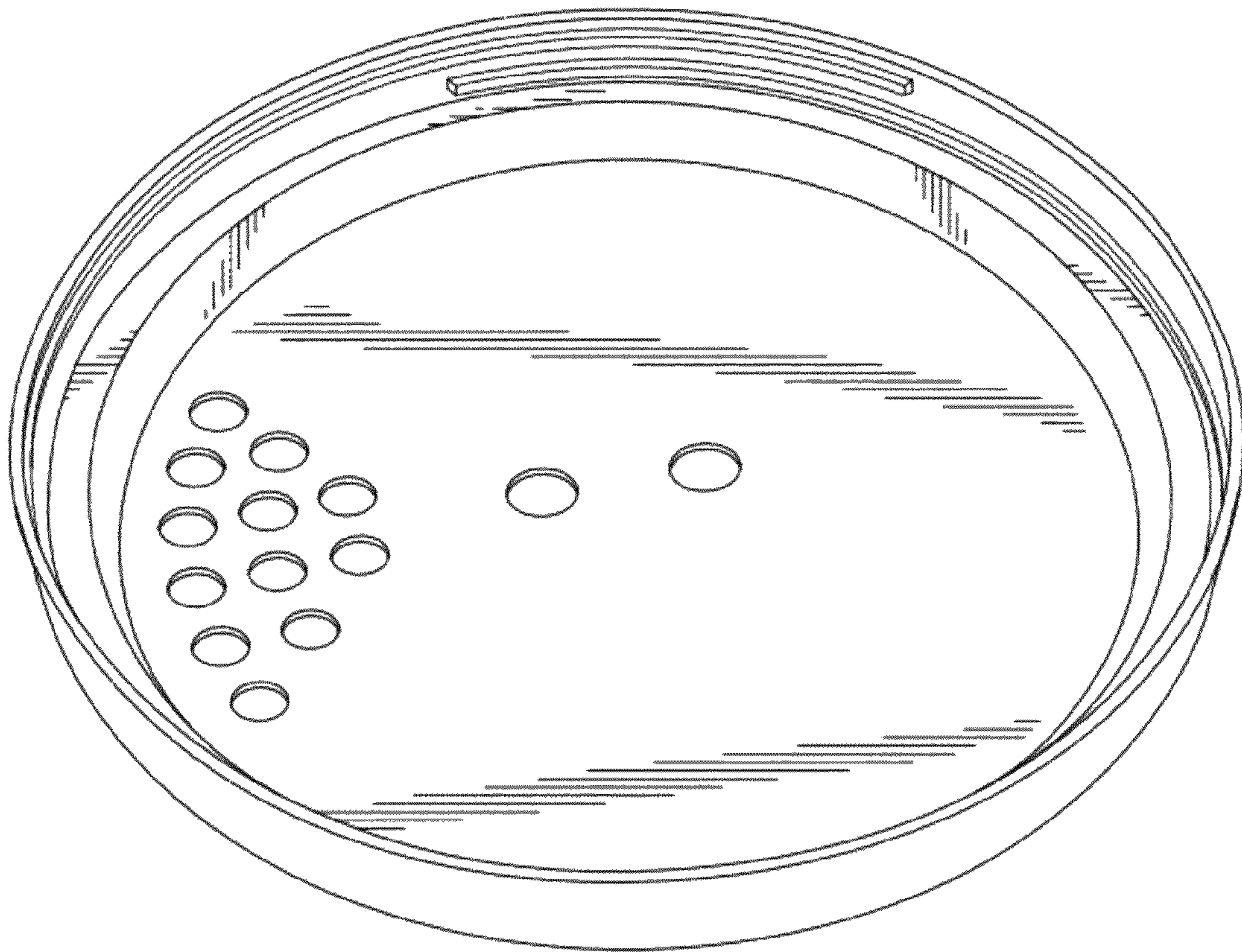

FIG. 14

