



US00D657575S

(12) **United States Design Patent**
Weber

(10) **Patent No.:** **US D657,575 S**

(45) **Date of Patent:** **** Apr. 17, 2012**

(54) **GOLF BAG-TAG DISPLAY**

(76) **Inventor:** **Gregory Peter A. Weber**, Red Bank, NJ (US)

(**) **Term:** **14 Years**

(21) **Appl. No.:** **29/389,023**

(22) **Filed:** **Apr. 6, 2011**

(51) **LOC (9) Cl.** **06-07**

(52) **U.S. Cl.** **D6/300**

(58) **Field of Classification Search** D6/300-314,
D6/444; 40/700, 711, 714, 716, 720, 735,
40/745, 765, 766, 780, 790; D20/10; D11/132,
D11/133

See application file for complete search history.

(56) **References Cited**

U.S. PATENT DOCUMENTS

D411,482 S *	6/1999	Huston	D11/132
D459,094 S *	6/2002	Stone et al.	D6/309
D488,626 S *	4/2004	Kruger	D6/309
D530,525 S *	10/2006	Greene, II	D6/309
D534,359 S *	1/2007	Mayer	D6/309
D559,560 S *	1/2008	Mischel, Jr.	D6/309
D593,756 S *	6/2009	Mock	D6/309

* cited by examiner

Primary Examiner — Philip S Hyder

Assistant Examiner — Sydney Buffalow

(74) *Attorney, Agent, or Firm* — Saul Ewing LLP

(57) **CLAIM**

I claim the ornamental design for a golf bag-tag display, as shown and described.

DESCRIPTION

FIG. 1 is a perspective view of a golf bag-tag display device in accordance with my new design;

FIG. 2 is a front view thereof;

FIG. 3 is a top side view thereof;

FIG. 4 is a right side view thereof;

FIG. 5 is a left side view thereof;

FIG. 6 is a bottom side view thereof;

FIG. 7 is a rear view thereof;

FIG. 8 is a perspective view of a golf bag-tag display device in accordance with an alternative embodiment of my new design;

FIG. 9 is a front view thereof;

FIG. 10 is a top side view thereof;

FIG. 11 is a right side view thereof;

FIG. 12 is a left side view thereof;

FIG. 13 is a bottom side view thereof; and,

FIG. 14 is a rear view thereof.

The five superimposed shapes shown in broken line in FIGS. 1 and 8 are exemplary of displayed golf bag-tags that may be displayed in conjunction with the claimed design, are shown for illustrative purposes only, and are in no way intended to form part of the claimed design.

The circumferential lines shown in broken line in FIGS. 8 and 9 are exemplary of contours of a circumferential molding bordering the field on which the displayed golf bag-tags are displayed, are shown for illustrative purposes only, and are in no way intended to form part of the claimed design.

1 Claim, 6 Drawing Sheets

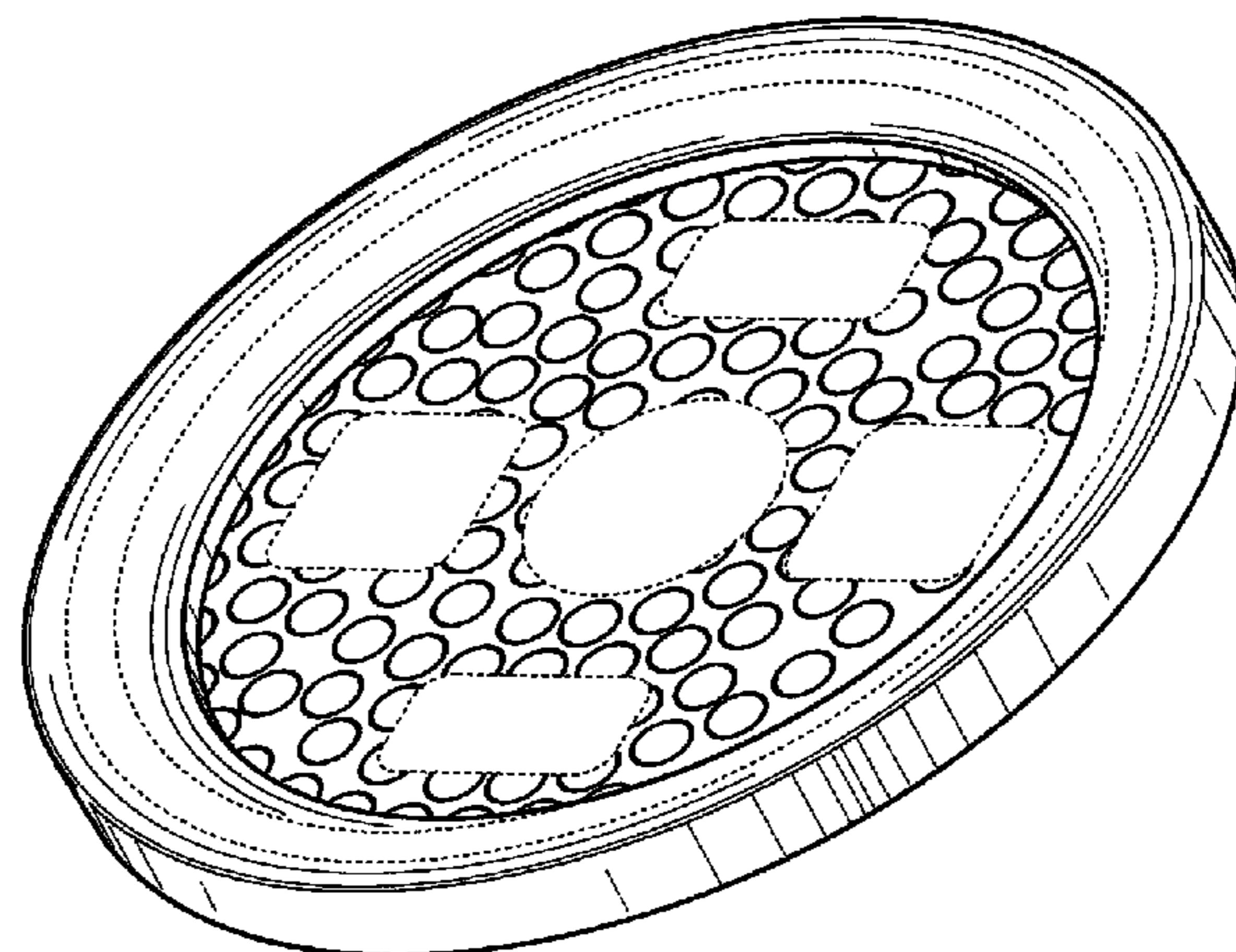
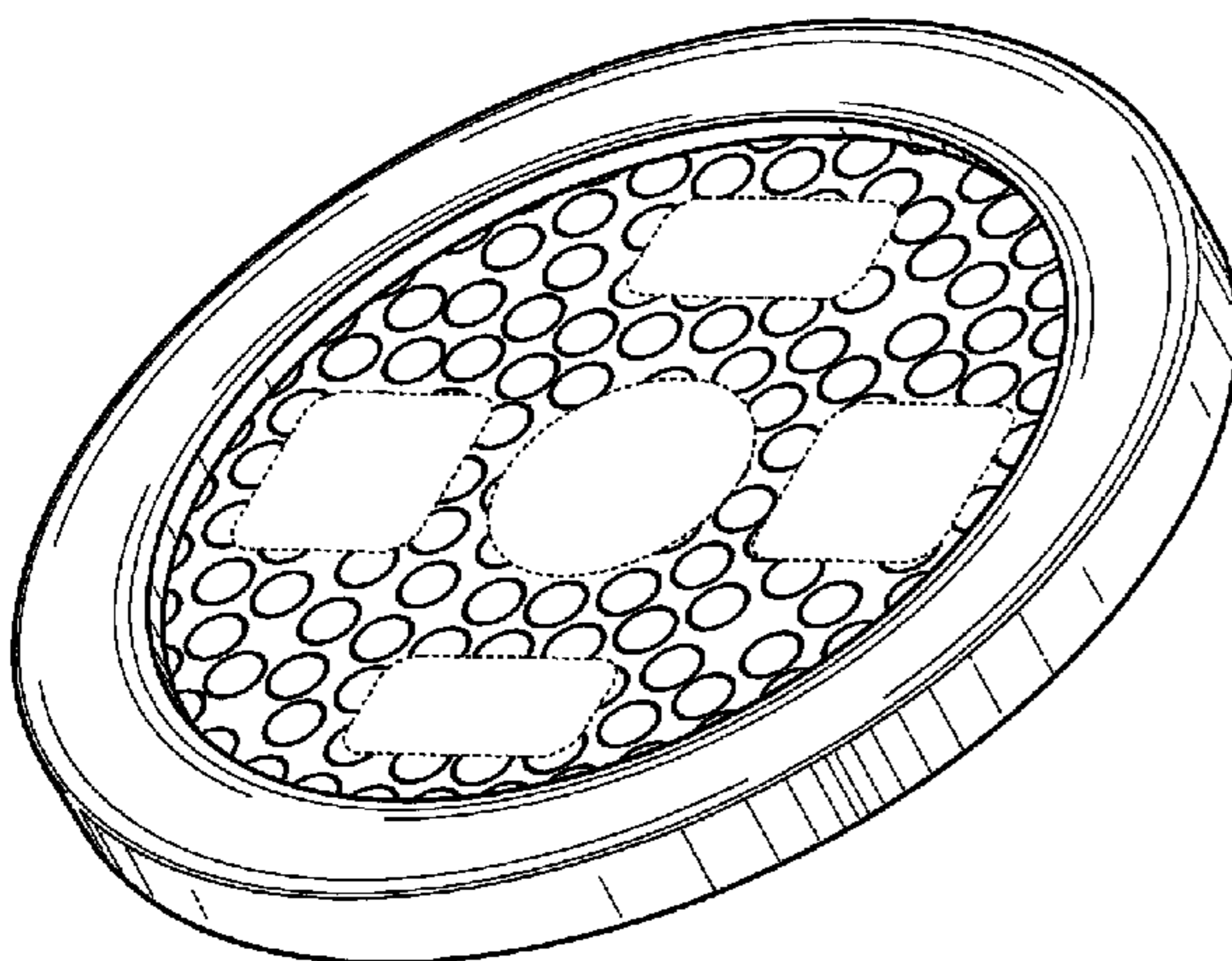

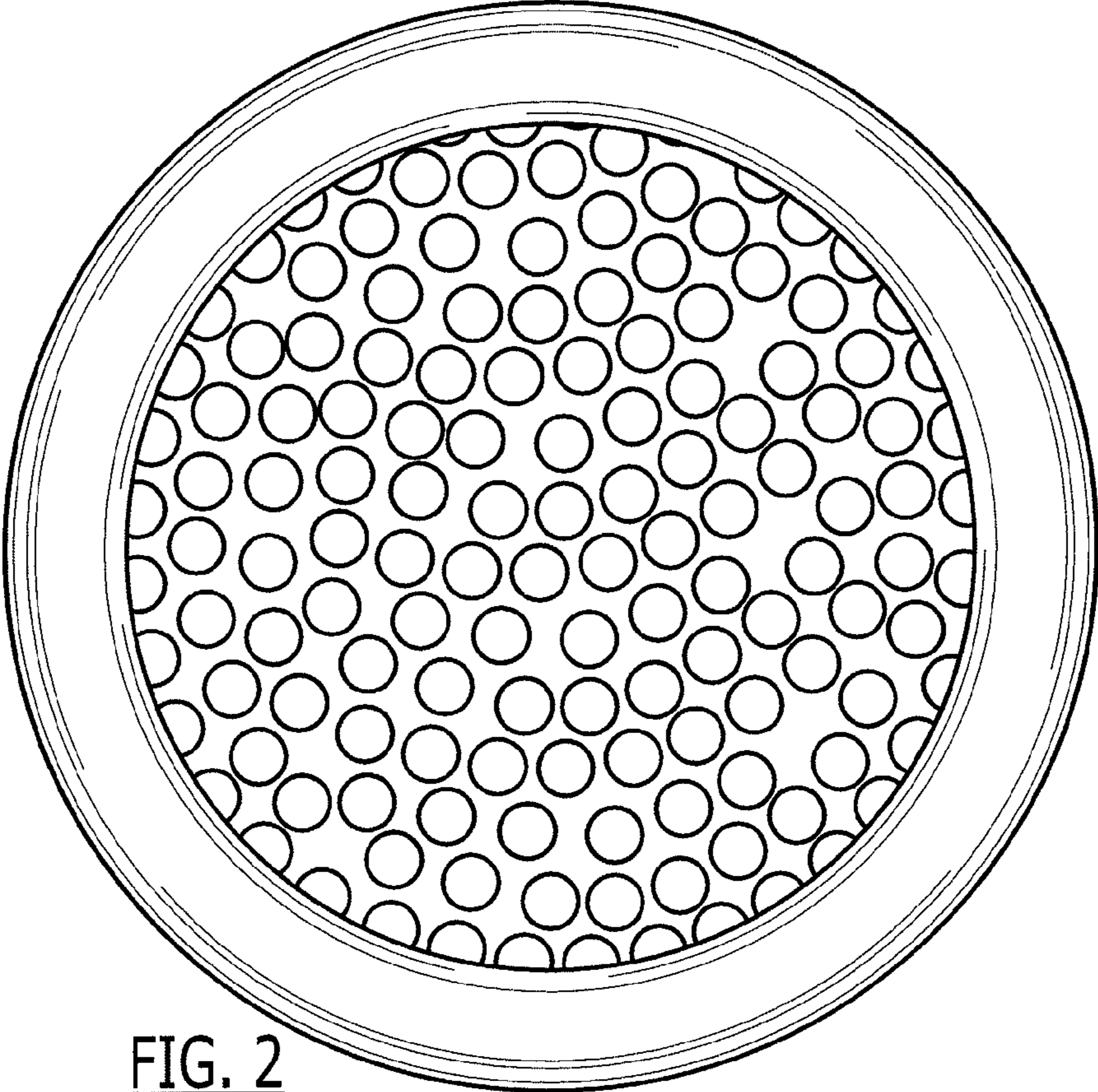
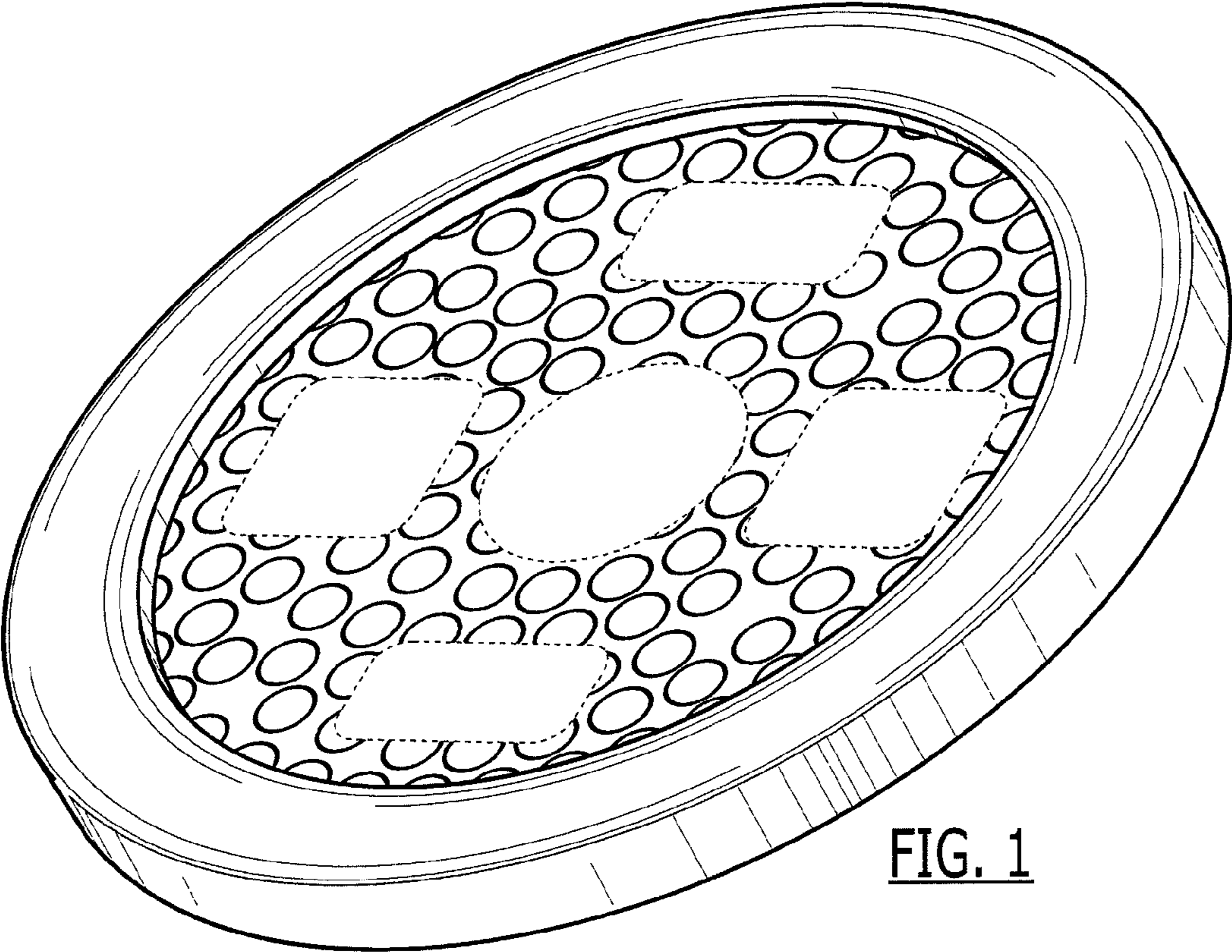

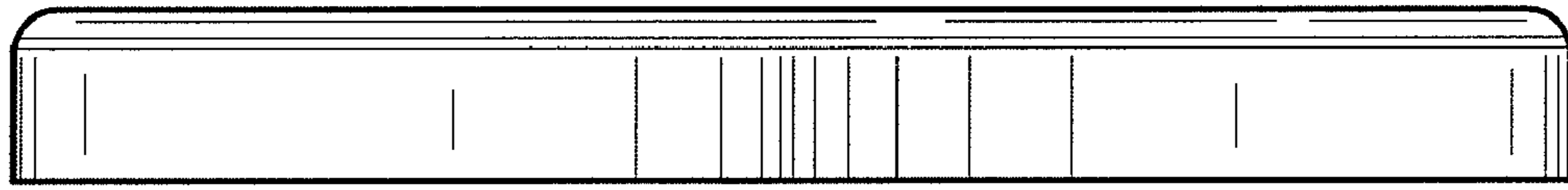

FIG. 3



FIG. 4

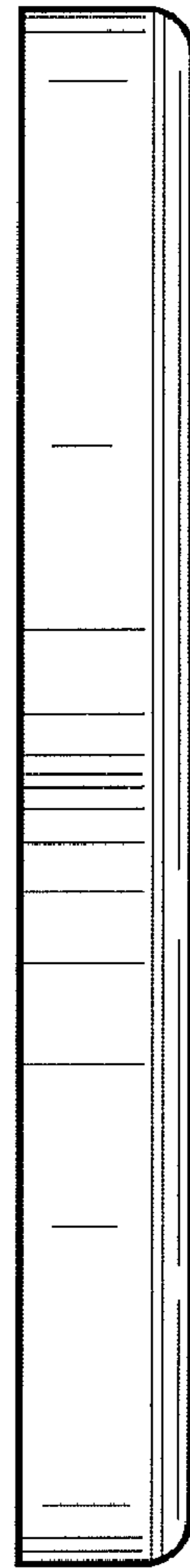

FIG. 5

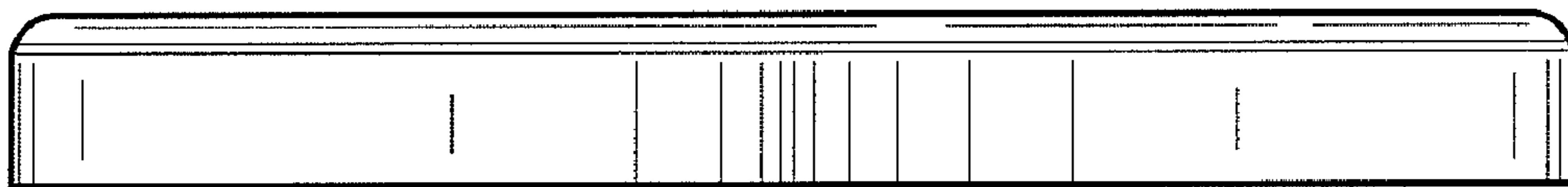

FIG. 6

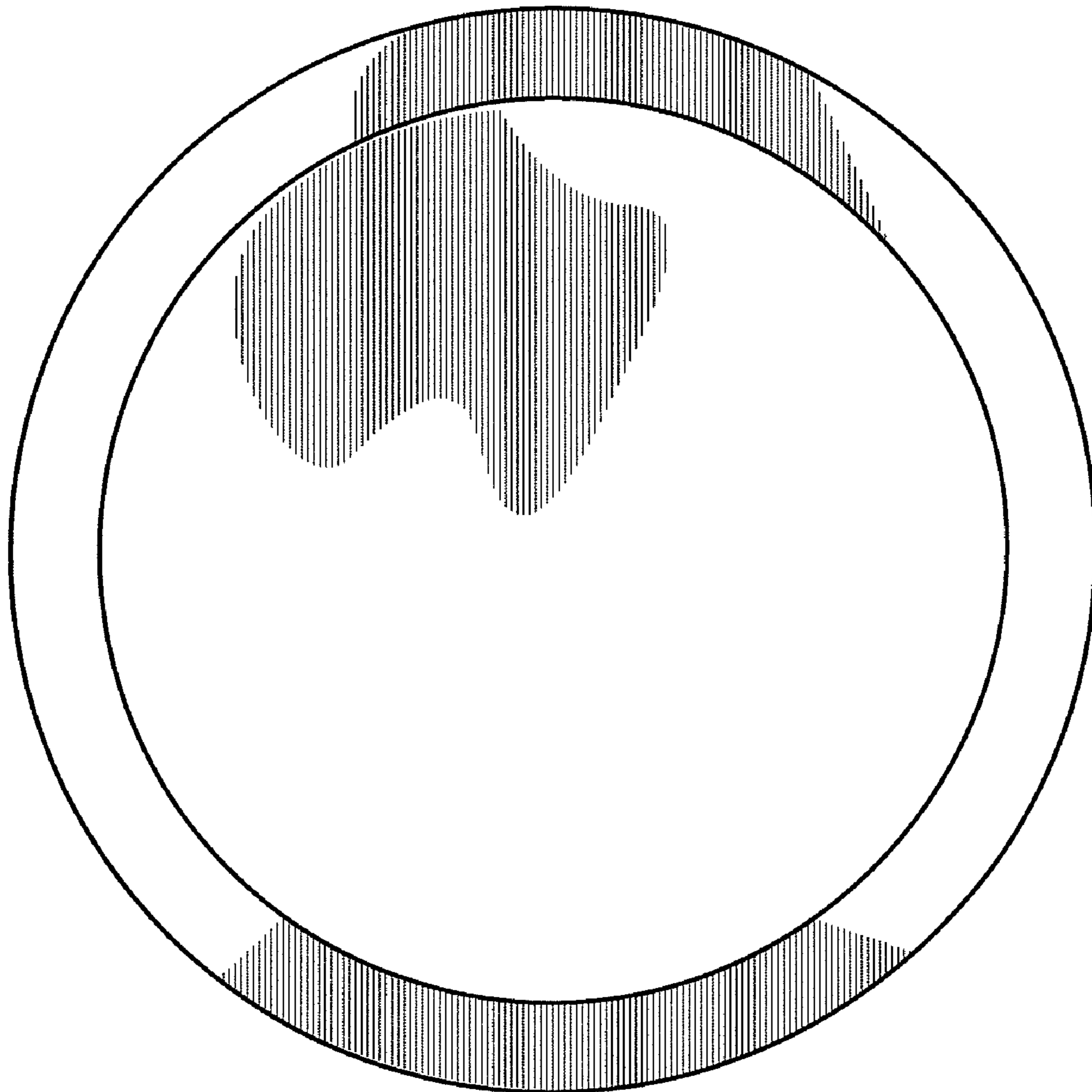

FIG. 7

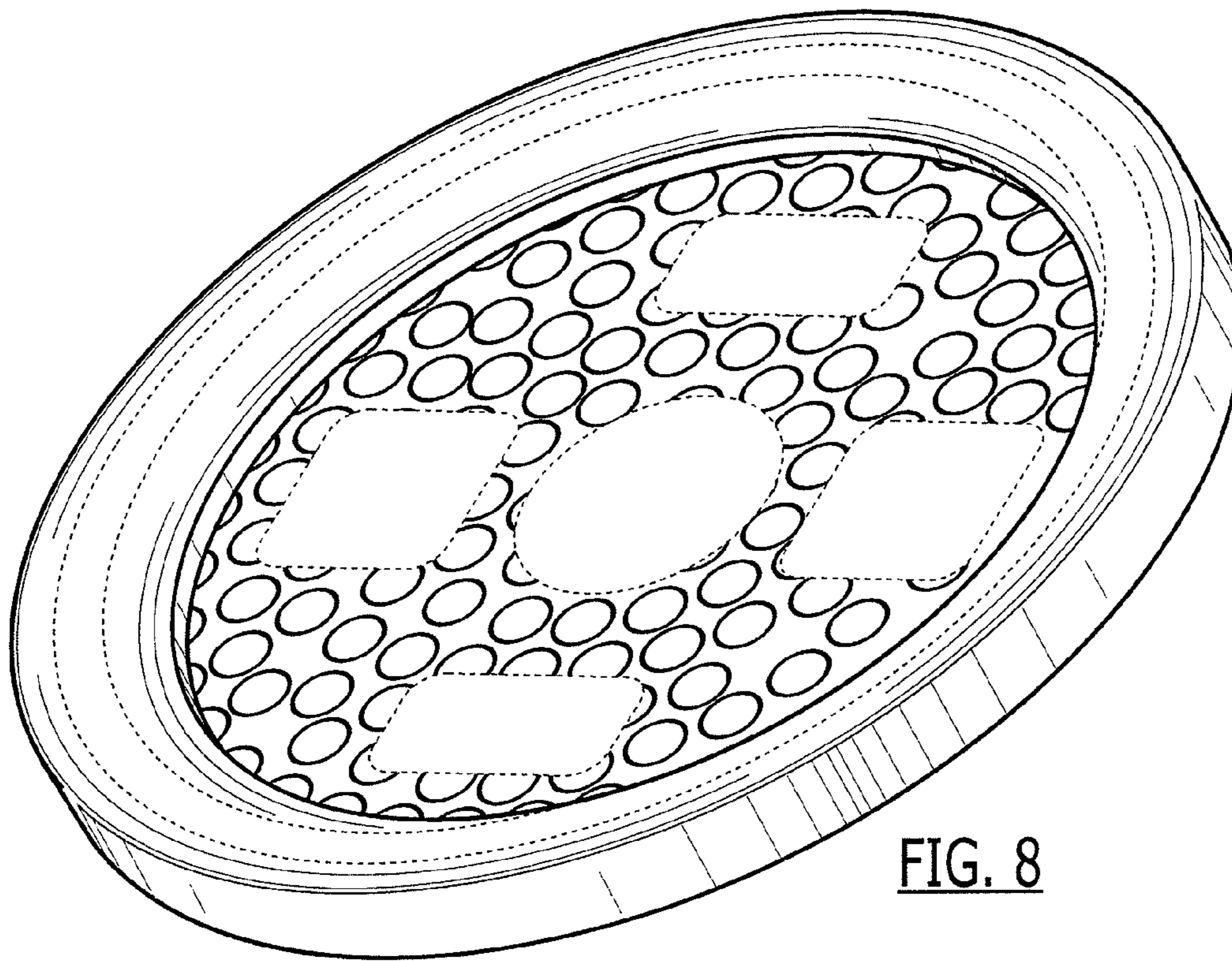

FIG. 8

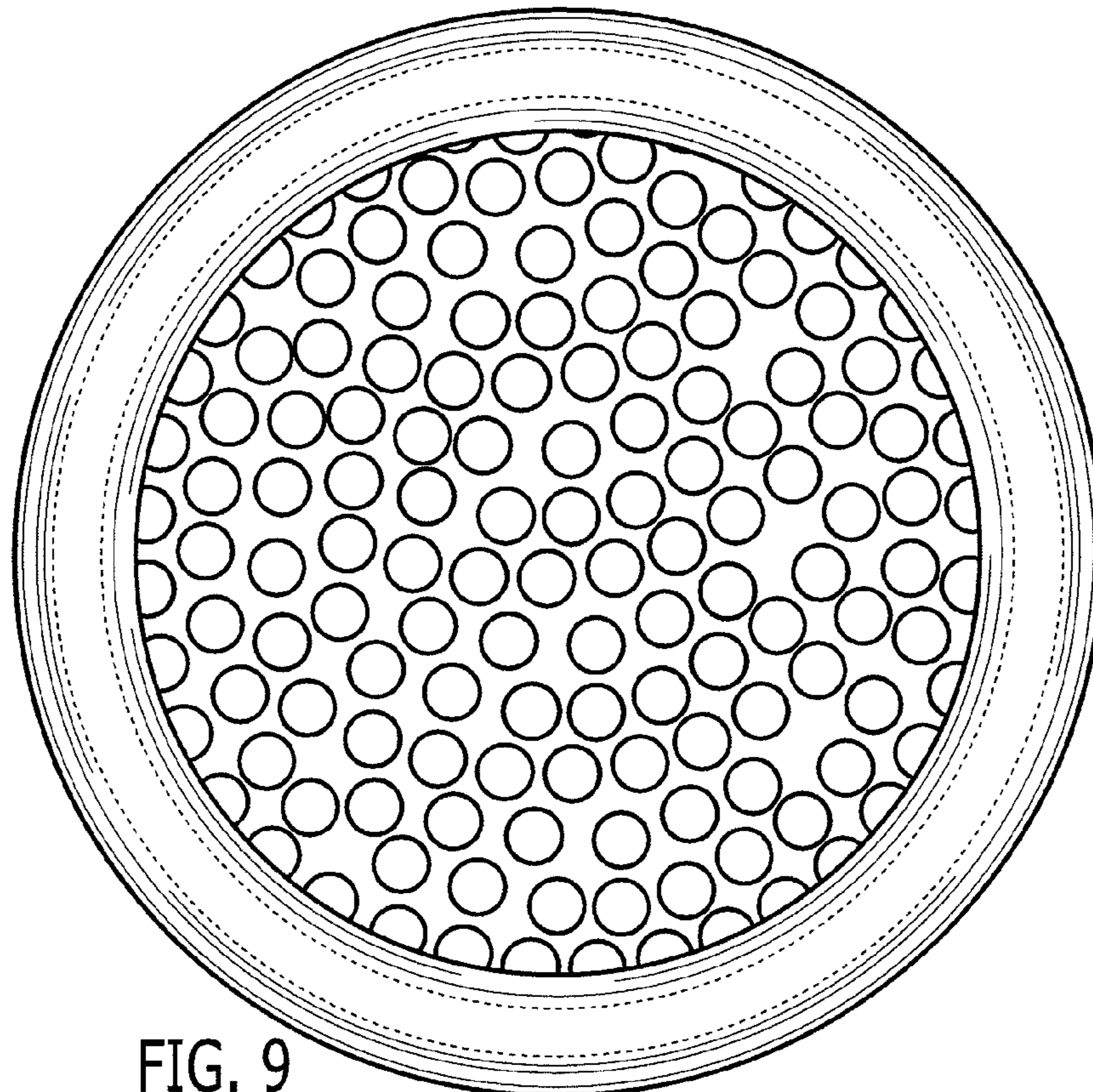

FIG. 9

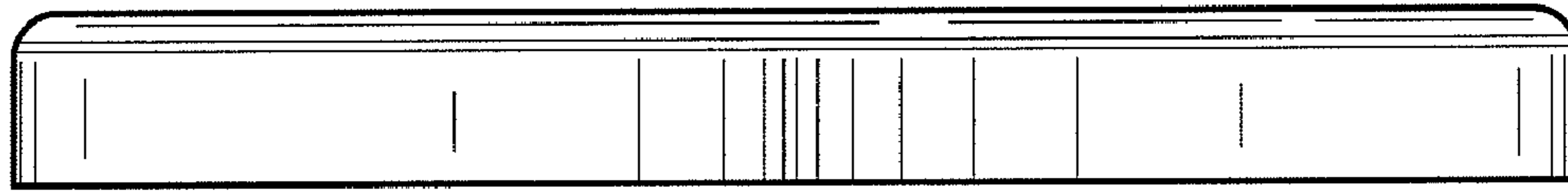

FIG. 10

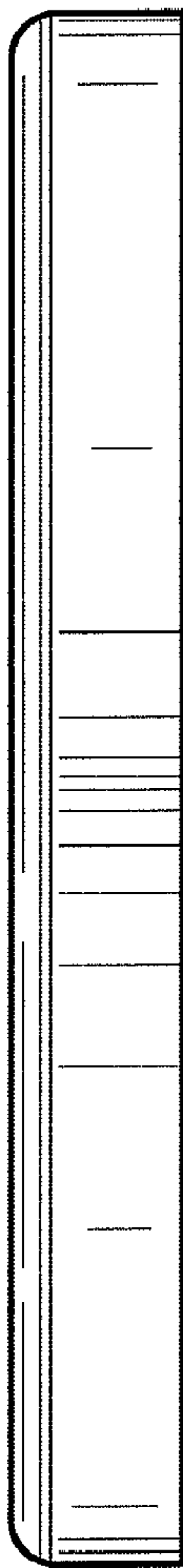

FIG. 11

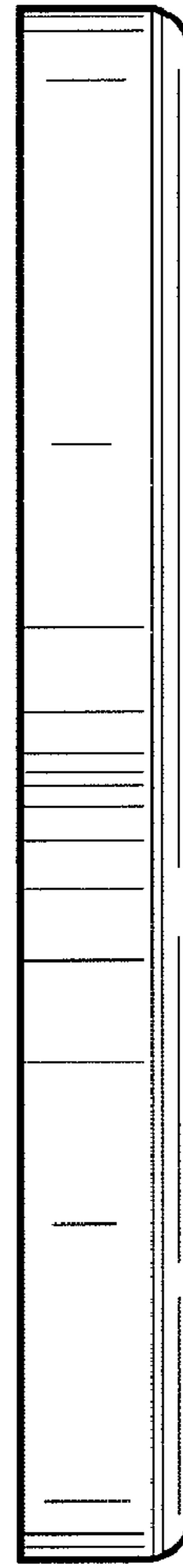

FIG. 12

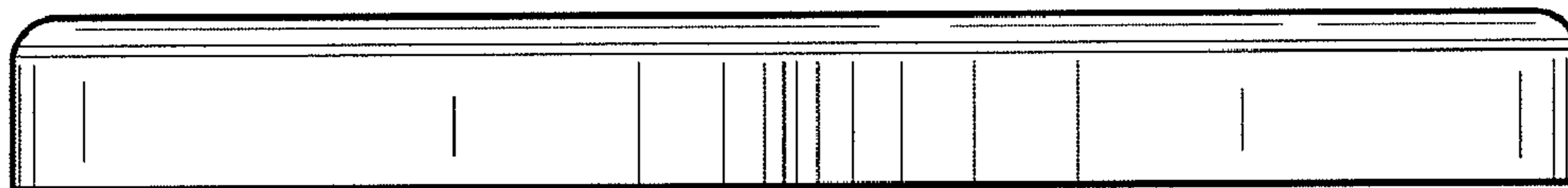

FIG. 13

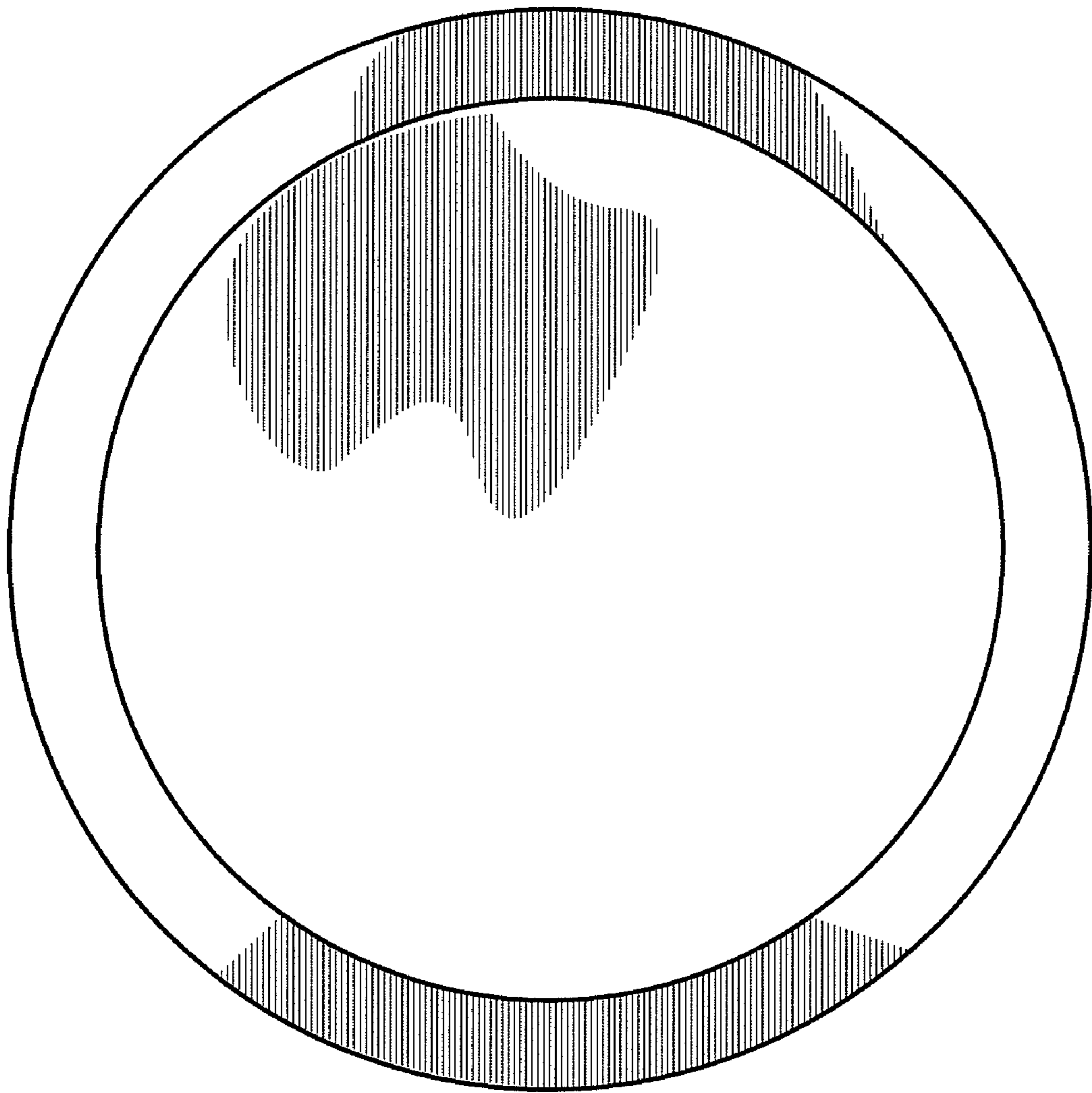

FIG. 14