



US00D657435S

(12) **United States Design Patent**  
**Wilke**

(10) **Patent No.:** **US D657,435 S**

(45) **Date of Patent:** **\*\* Apr. 10, 2012**

(54) **LIGHTED HUNTING KNIFE**

(75) Inventor: **Tom Wilke**, Spartanburg, SC (US)

(73) Assignee: **TPG Universal II, LLC**, Spartanburg, SC (US)

(\*\*) Term: **14 Years**

(21) Appl. No.: **29/387,111**

(22) Filed: **Mar. 9, 2011**

(51) **LOC (9) Cl.** ..... **22-02**

(52) **U.S. Cl.** ..... **D22/118**

(58) **Field of Classification Search** ..... D22/118;  
D8/95-99; D7/643, 649; 30/125, 155, 287,  
30/299, 314, 337, 350, 353; 362/119, 158,  
362/187; D26/38

See application file for complete search history.

(56) **References Cited**

**U.S. PATENT DOCUMENTS**

D353,011 S \* 11/1994 Miller ..... D26/38  
D400,632 S \* 11/1998 Powell ..... D22/118  
D412,355 S \* 7/1999 Sætherbo ..... D22/118

6,658,743 B2 \* 12/2003 Dudley et al. .... 30/314  
D561,295 S \* 2/2008 Taylor et al. .... D22/118  
D584,377 S \* 1/2009 MacNair et al. .... D22/118

\* cited by examiner

*Primary Examiner* — Catheri Oliver

(74) *Attorney, Agent, or Firm* — Douglas W. Kim; McNair Law Firm, P.A.

(57) **CLAIM**

The ornamental design for a lighted hunting knife, as shown and described.

**DESCRIPTION**

FIG. 1 is a perspective view of the lighted hunting knife design;

FIG. 2 is a side view of the lighted hunting knife design;

FIG. 3 is a side view of the lighted hunting knife design;

FIG. 4 is a top view of the lighted hunting knife design;

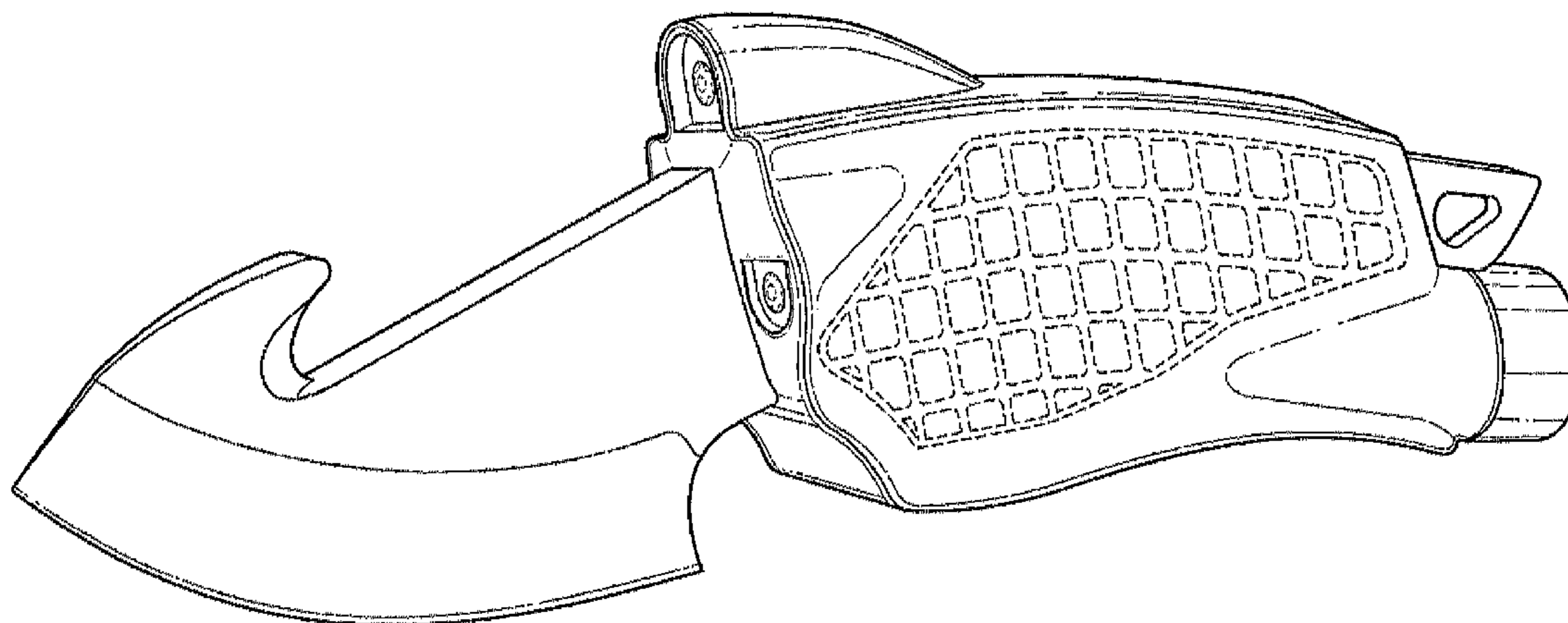
FIG. 5 is a bottom view of the lighted hunting knife design;

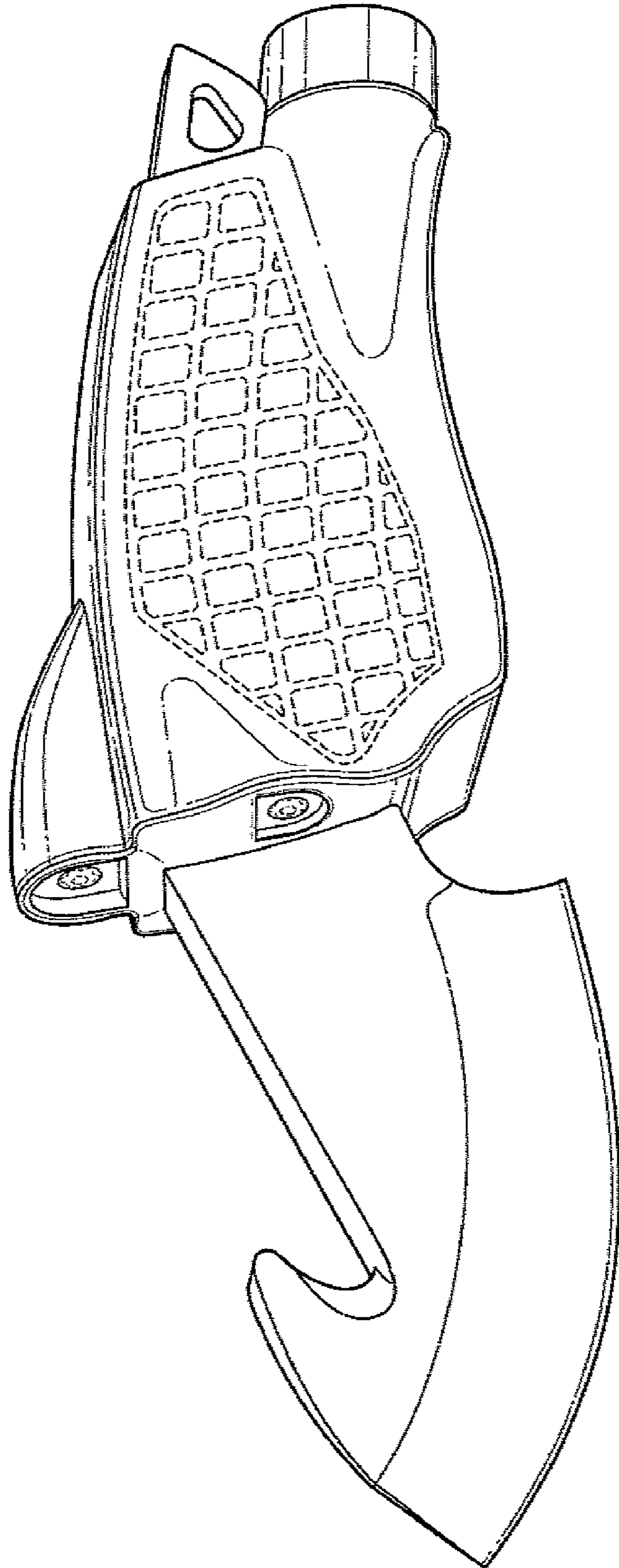
FIG. 6 is a front view of the lighted hunting knife design; and,

FIG. 7 is a rear view of the lighted hunting knife design.

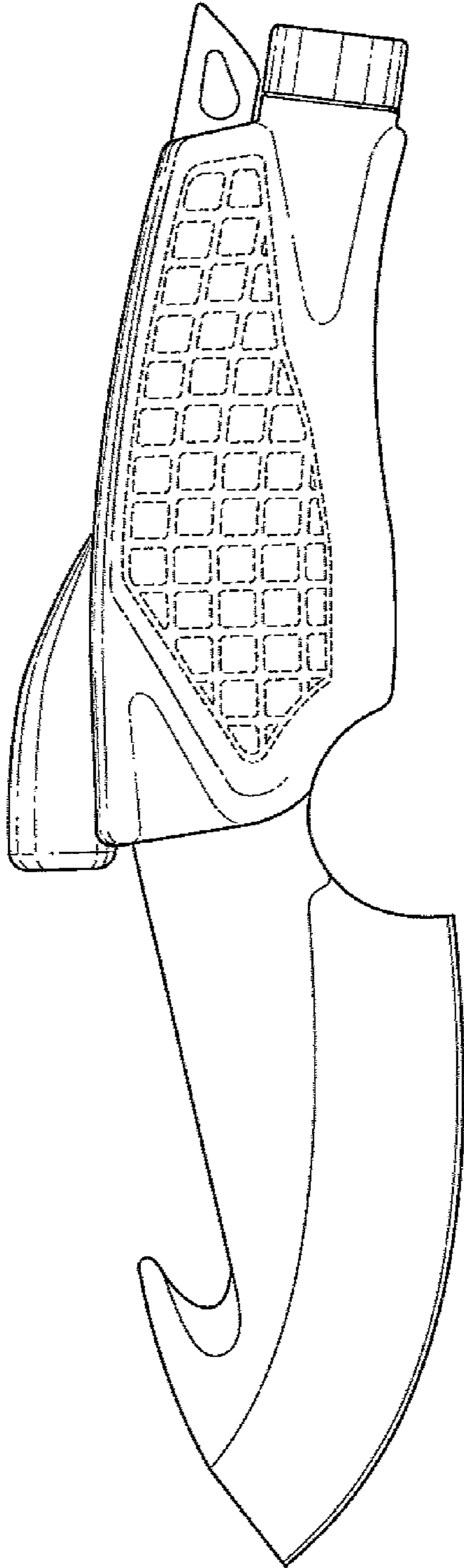
The broken line disclosures of the pattern on the handle shown are for illustrative purposes only and form no part of the claimed design.

**1 Claim, 4 Drawing Sheets**

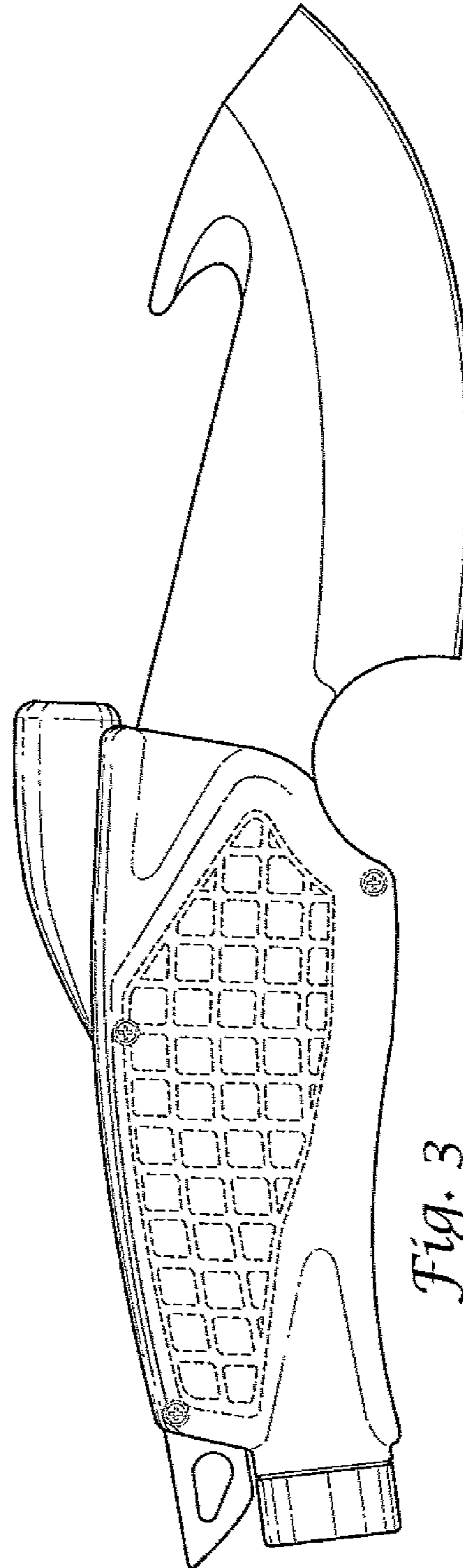




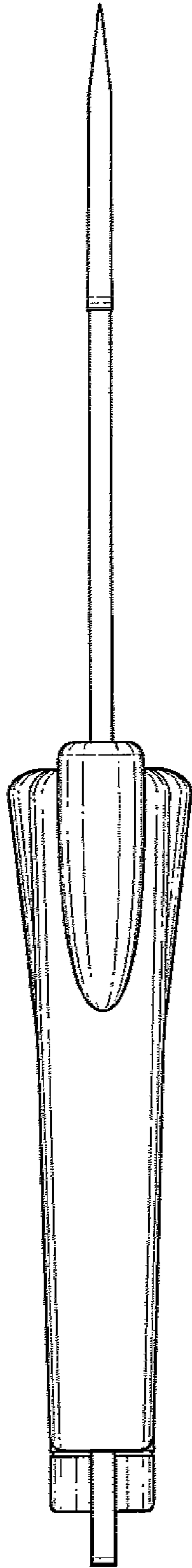
*Fig. 1*



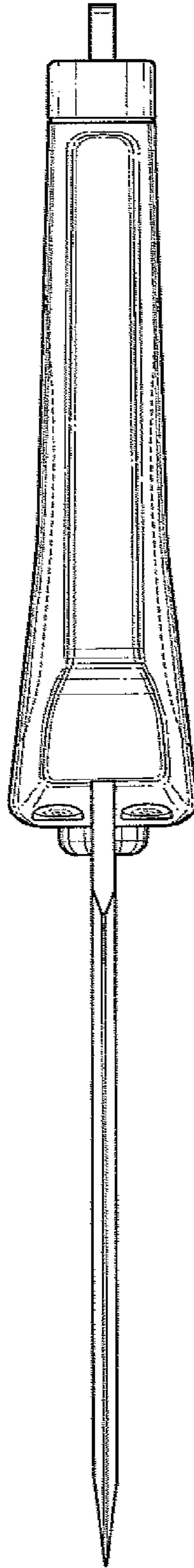
*Fig. 2*



*Fig. 3*

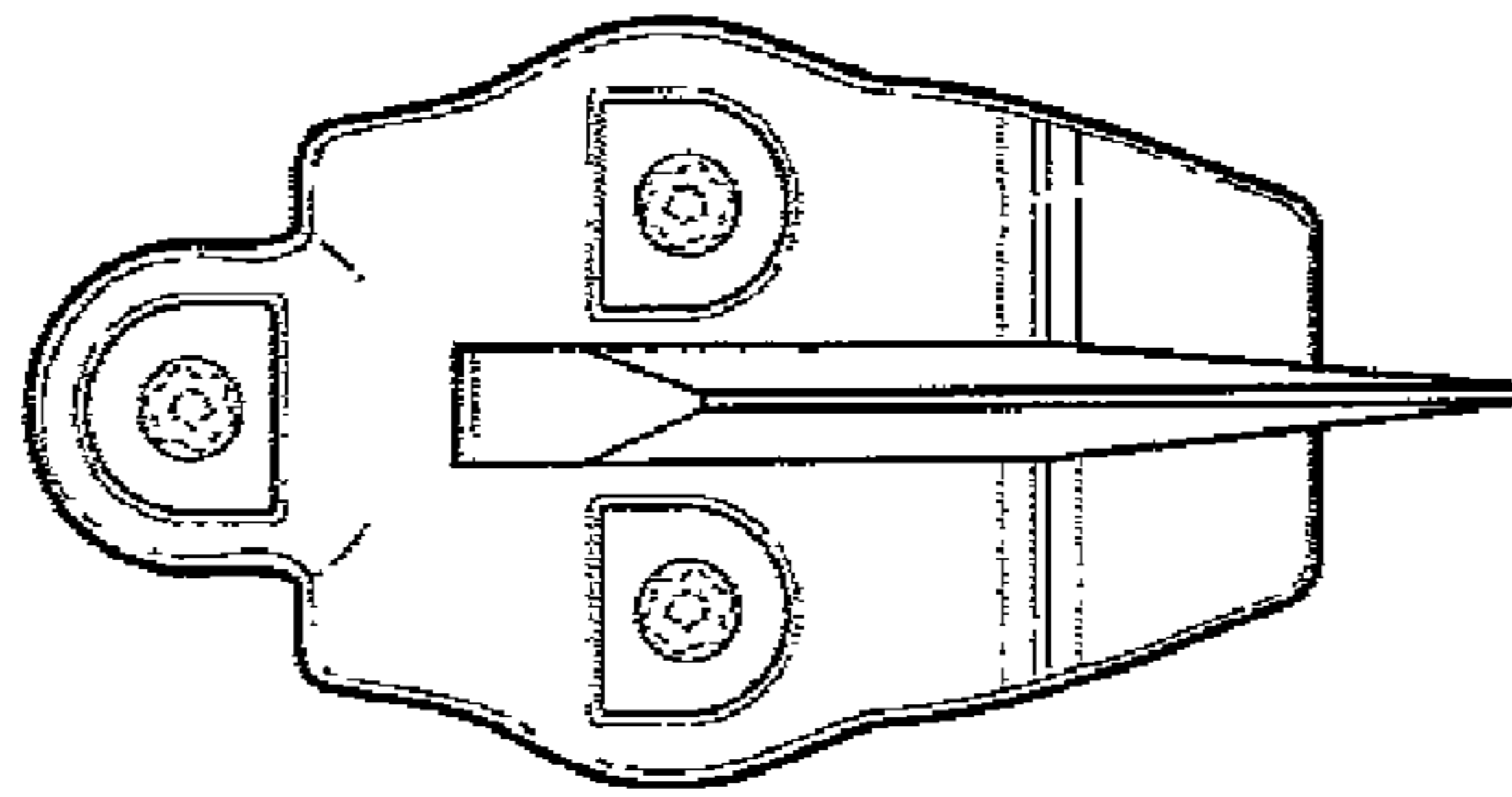
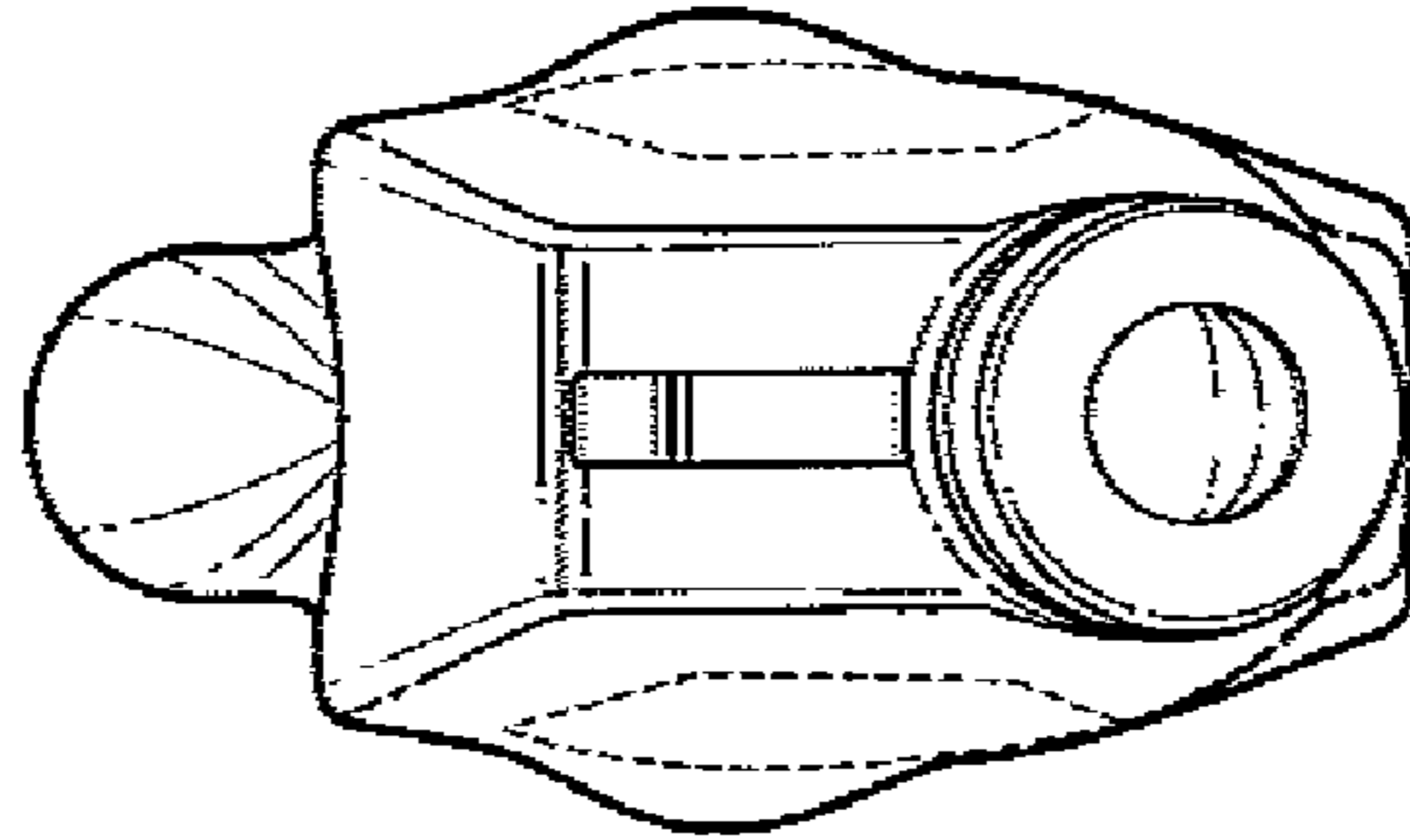


*Fig. 4*



*Fig. 5*

*Fig. 7*



*Fig. 6*