



US00D657354S

(12) **United States Design Patent**
Kim

(10) **Patent No.:** **US D657,354 S**

(45) **Date of Patent:** **** Apr. 10, 2012**

(54) **MOBILE PHONE CASE**

(75) Inventor: **Yoon-Young Kim, Yongin-si (KR)**

(73) Assignee: **Samsung Electronics Co., Ltd. (KR)**

(**) Term: **14 Years**

(21) Appl. No.: **29/400,356**

(22) Filed: **Aug. 26, 2011**

(30) **Foreign Application Priority Data**

Jun. 10, 2011 (KR) 30-2011-0023734

(51) **LOC (9) Cl.** **14-03**

(52) **U.S. Cl.** **D14/250**

(58) **Field of Classification Search** D14/250–253,
D14/440, 203.3–203.7, 217, 496, 248, 238.1;
D3/201, 218, 269, 301, 273, 303; D13/103,
D13/107–108; 220/4.02; 248/309.1; 361/679.56;
379/426, 433.11, 455; 455/575.1, 575.8;
190/100; 206/305, 320

See application file for complete search history.

(56) **References Cited**

U.S. PATENT DOCUMENTS

D317,977 S *	7/1991	Felkner et al.	D3/299
D414,033 S *	9/1999	Rohm	D3/249
D551,846 S *	10/2007	Ko et al.	D3/201
D557,495 S *	12/2007	Chan et al.	D3/218
D582,405 S *	12/2008	Andre et al.	D3/299
D582,661 S *	12/2008	Katsof	D3/201
D601,959 S *	10/2009	Lee et al.	D13/119
D601,992 S *	10/2009	Choi et al.	D14/138 AB
D620,931 S *	8/2010	Opman	D14/250
D621,396 S *	8/2010	Lee et al.	D14/252
D624,304 S *	9/2010	Danze et al.	D3/201
D625,303 S *	10/2010	Kim	D14/250
D628,374 S *	12/2010	Lee et al.	D3/201
D638,006 S *	5/2011	Chang	D14/250

D641,348 S *	7/2011	Kim et al.	D14/250
D646,266 S *	10/2011	Kim et al.	D14/250
D647,892 S *	11/2011	Ragde, Jr.	D14/238.1
D648,529 S *	11/2011	Brown	D3/269
2008/0053770 A1 *	3/2008	Tynyk	190/100
2010/0224519 A1 *	9/2010	Kao	206/320

OTHER PUBLICATIONS

Mobile Phone Wallet Design Leather Flip Case Cover Croco Style for Samsung i9100 Galaxy S2, <URL:http://www.aliexpress.com/fm-store/603831/210535528-495163399/Free-Shipping-Mobile-Phone-Wallet-Design-Leather-Flip-Case-Cover-Croco-Style-for-Samsung-i9100-Galaxy.html>, retrieved from internet Dec. 17, 2011.*

Official Samsung Galaxy Note Flip Cover Review, posted on Nov. 28, 2011, <URL:http://droid-den.com/accessory-reviews/official-samsung-galaxy-note-flip-cover-review/>, retrieved from internet Dec. 17, 2011.*

* cited by examiner

Primary Examiner — Carla Wright

(74) *Attorney, Agent, or Firm* — NSIP Law

(57) **CLAIM**

The ornamental design for a mobile phone case, as shown and described.

DESCRIPTION

FIG. 1 is a perspective view of a mobile phone case; FIG. 2 is a front view of the mobile phone case of FIG. 1; FIG. 3 is a rear view of the mobile phone case of FIG. 1; FIG. 4 is a left-side view of the mobile phone case of FIG. 1; FIG. 5 is a right-side view of the mobile phone case of FIG. 1; FIG. 6 is a top plan view of the mobile phone case of FIG. 1; FIG. 7 is a bottom plan view of the mobile phone case of FIG. 1; and, FIG. 8 is a perspective view of the mobile phone case of FIG. 1 shown in an open state. In FIG. 8, the broken lines depict an unclaimed mobile phone. The broken lines form no part of the claimed design.

1 Claim, 6 Drawing Sheets

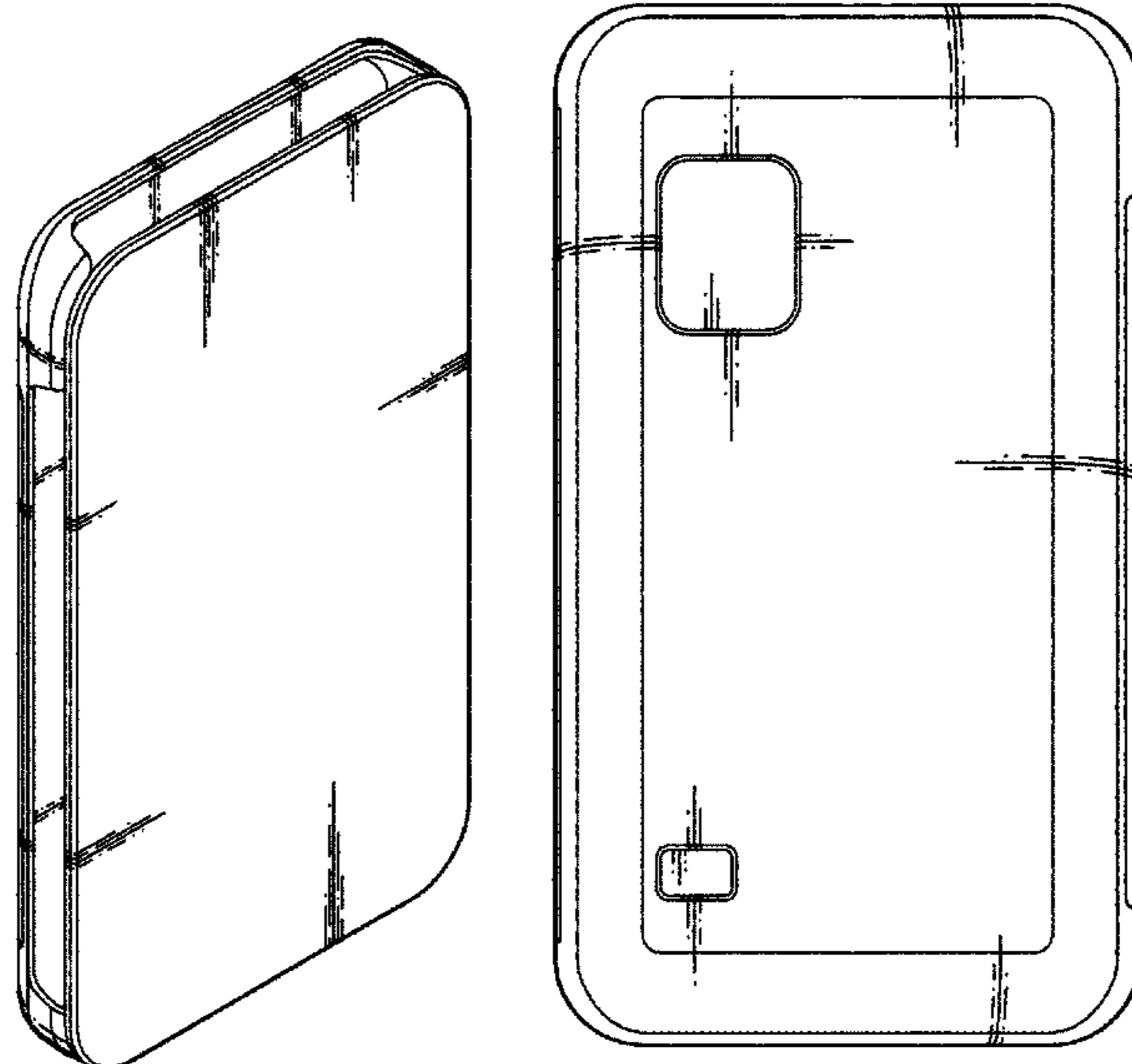

FIG. 1

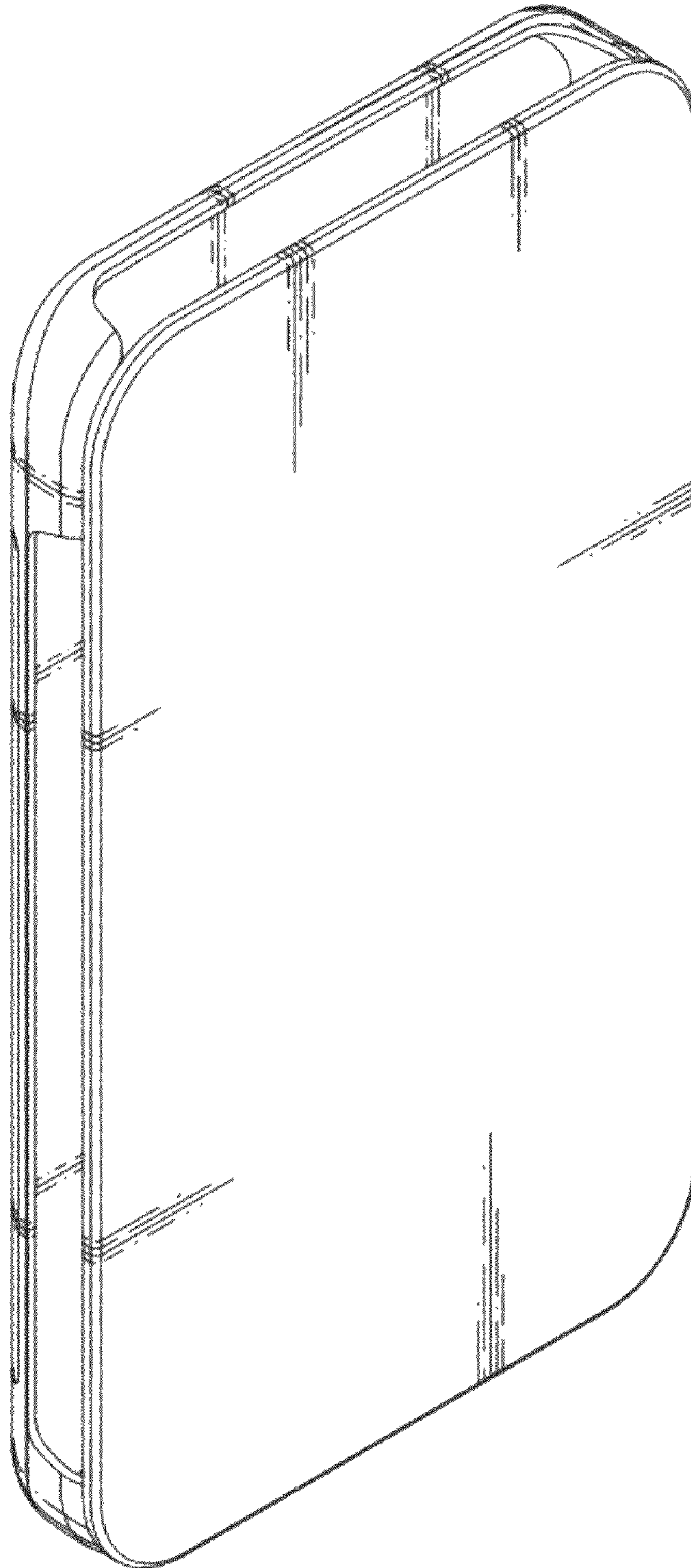

FIG. 2

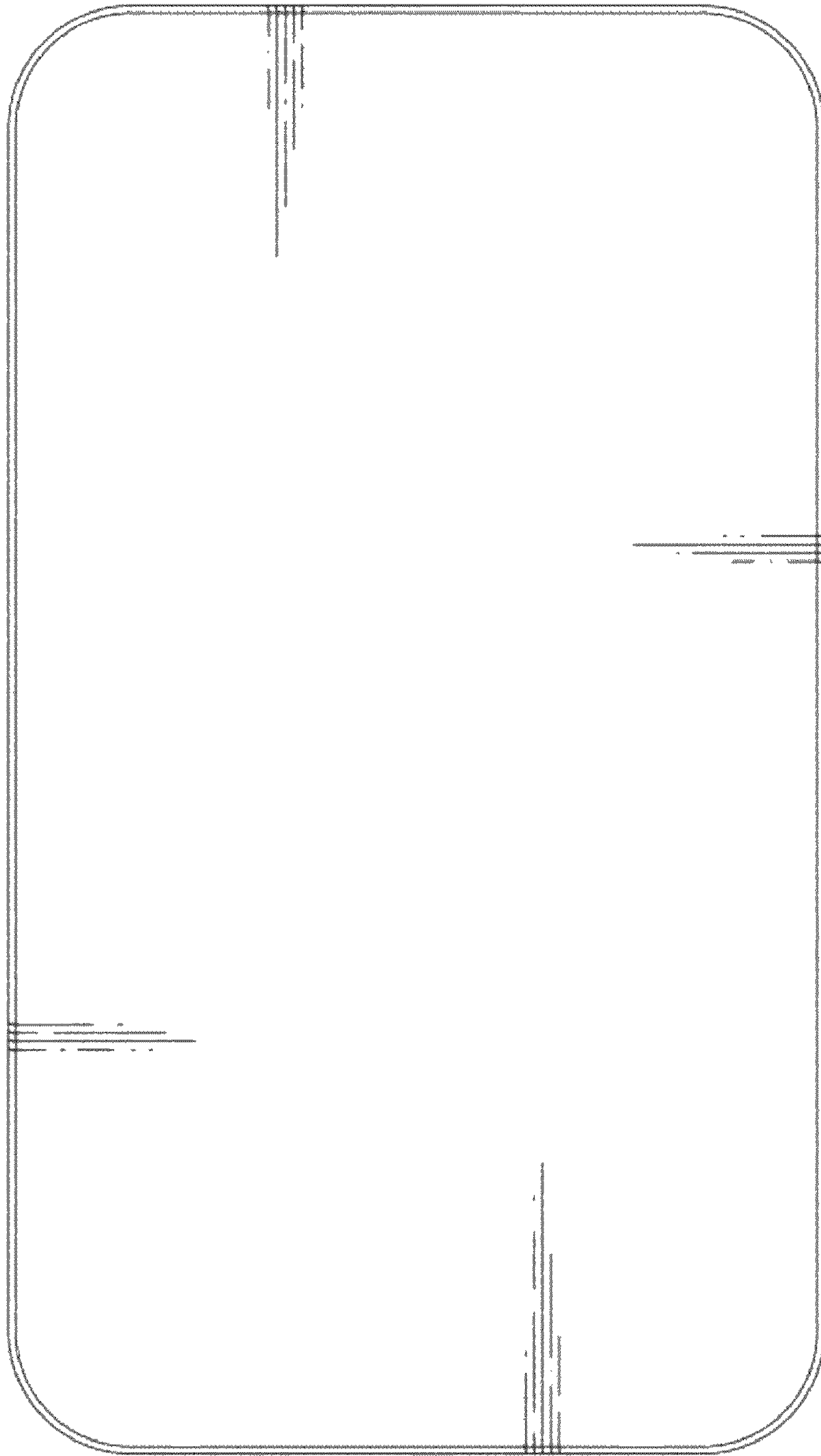

FIG. 3

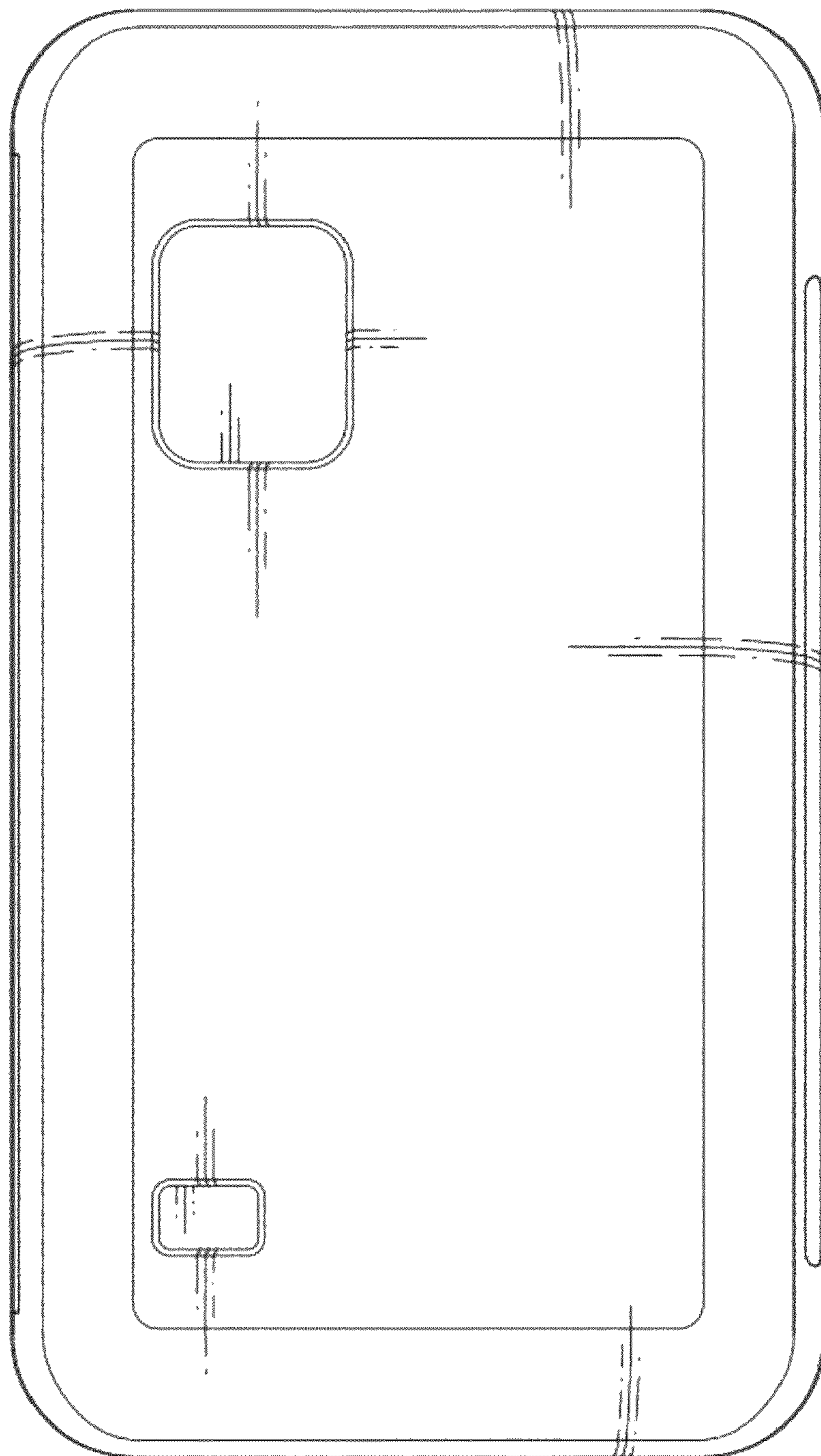

FIG. 4

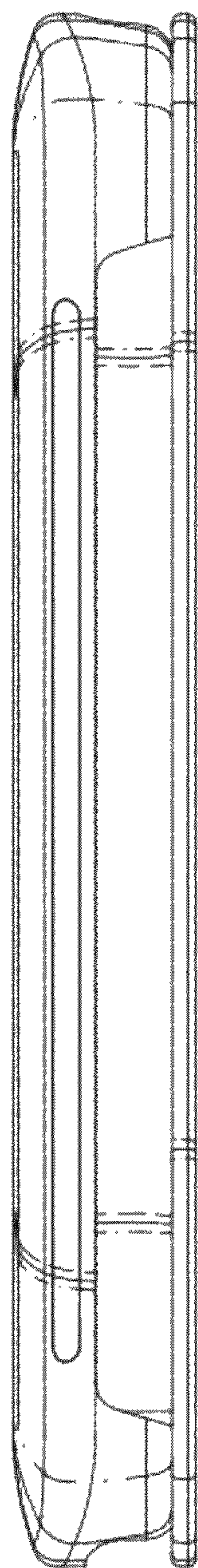

FIG. 5

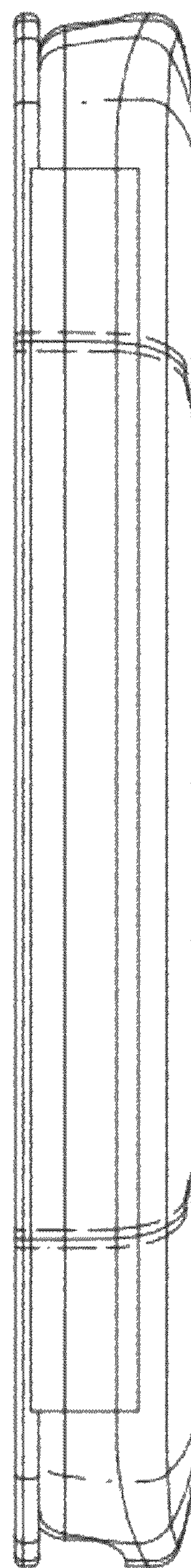

FIG. 6



FIG. 7

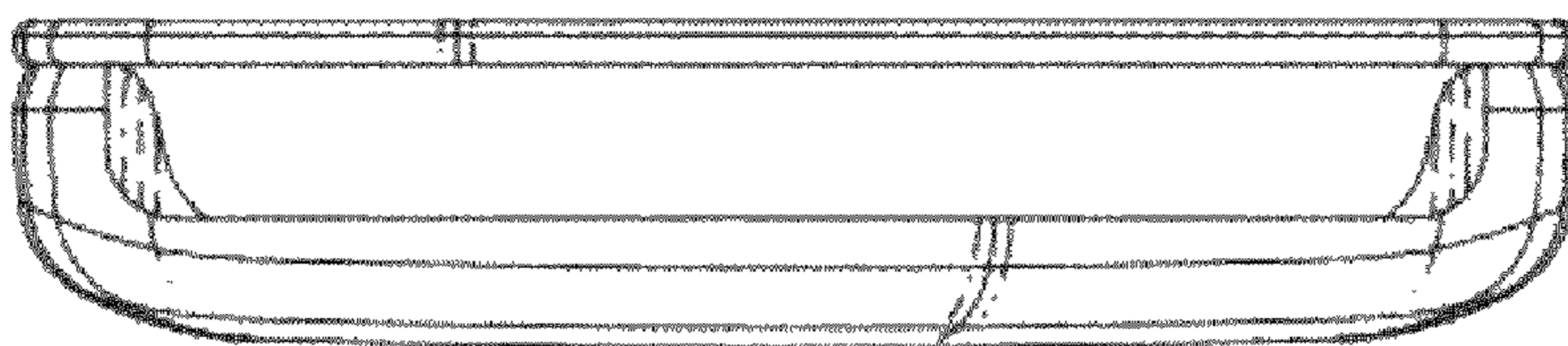

FIG. 8

