



US00D657234S

(12) **United States Design Patent**
Herman

(10) **Patent No.:** **US D657,234 S**

(45) **Date of Patent:** **** Apr. 10, 2012**

(54) **SOFT SHACKLE**

(76) Inventor: **Edward J. Herman**, Annapolis, MD
(US)

(**) Term: **14 Years**

(21) Appl. No.: **29/380,501**

(22) Filed: **Dec. 7, 2010**

(51) **LOC (9) Cl.** **08-08**

(52) **U.S. Cl.** **D8/382**

(58) **Field of Classification Search** D21/624;
D30/160; D8/383, 382, 44, 333, 356, 1;
D11/5, 212-219; D2/607; D6/578

See application file for complete search history.

(56) **References Cited**

U.S. PATENT DOCUMENTS

D228,618	S	*	10/1973	Falk	D8/333
D228,619	S	*	10/1973	Falk	D8/333
4,924,811	A	*	5/1990	Axelrod	119/710
D319,605	S	*	9/1991	Jenks	D11/131
5,092,272	A	*	3/1992	O'Rourke	119/709
D328,805	S	*	8/1992	O'Rourke	D30/160
D329,310	S	*	9/1992	O'Rourke	D30/160
D330,100	S	*	10/1992	O'Rourke	D30/160
D371,645	S	*	7/1996	Lawson	D30/160
D382,678	S	*	8/1997	Weinacker, Jr.	D30/160
D399,612	S	*	10/1998	Weinacker, Jr.	D30/160
D436,147	S	*	1/2001	Barnes	D21/624
D456,958	S	*	5/2002	Weinacker, Jr.	D30/160
D465,885	S	*	11/2002	Weinacker, Jr.	D30/160
6,564,838	B1	*	5/2003	Cruickshank	150/118

D513,547	S	*	1/2006	Baron et al.	D30/160
D535,177	S	*	1/2007	Hsieh	D8/333
D563,214	S	*	3/2008	Yoshie et al.	D8/383
D563,777	S	*	3/2008	Yoshie et al.	D8/383
D567,642	S	*	4/2008	Tamura et al.	D8/383
D597,824	S	*	8/2009	Wang	D8/356

* cited by examiner

Primary Examiner — Cynthia M Chin

Assistant Examiner — Sheryl Lane

(74) *Attorney, Agent, or Firm* — Ober, Kaler, Grimes & Shriver; Royal W. Craig

(57) **CLAIM**

I claim the ornamental design for a soft shackle, as shown and described.

DESCRIPTION

FIG. 1 is an overhead perspective view of a soft shackle in a closed-loop configuration according to my new design.

FIG. 2 is a bottom perspective view of the soft shackle in a closed-loop configuration as in FIG. 1 rotated 180 degrees.

FIG. 3 is a side view of the soft shackle in a closed-loop configuration as in FIGS. 1-2.

FIG. 4 is an end view of the soft shackle in a closed-loop configuration as in FIGS. 1-3.

FIG. 5 is an end view of the soft shackle in a closed-loop configuration opposite that of FIG. 4.

FIG. 6 is a top view of the soft shackle in a closed-loop configuration as in FIGS. 1-5; and,

FIG. 7 is a side view of the soft shackle as in FIGS. 1-6 in an open configuration.

1 Claim, 5 Drawing Sheets

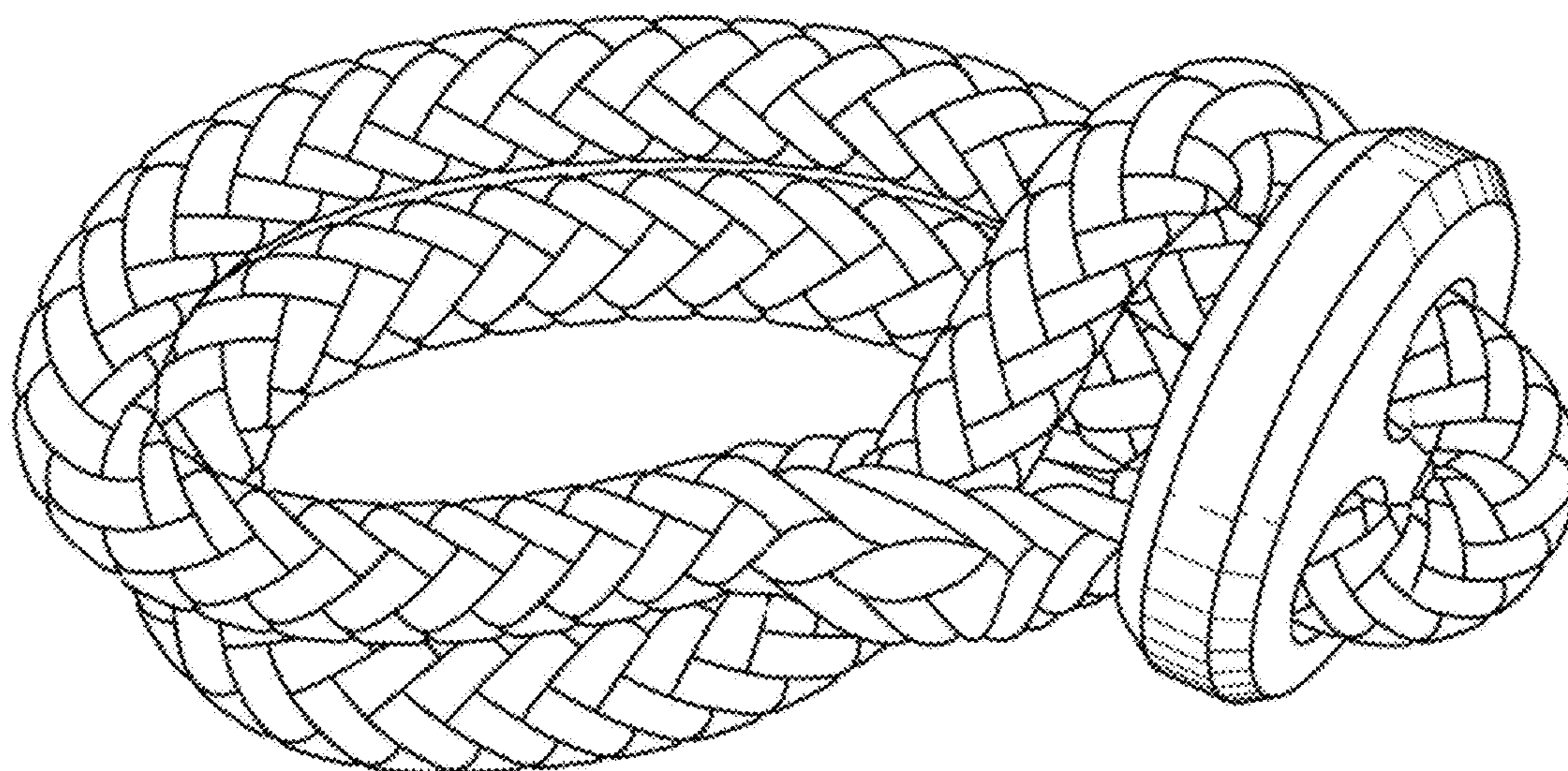

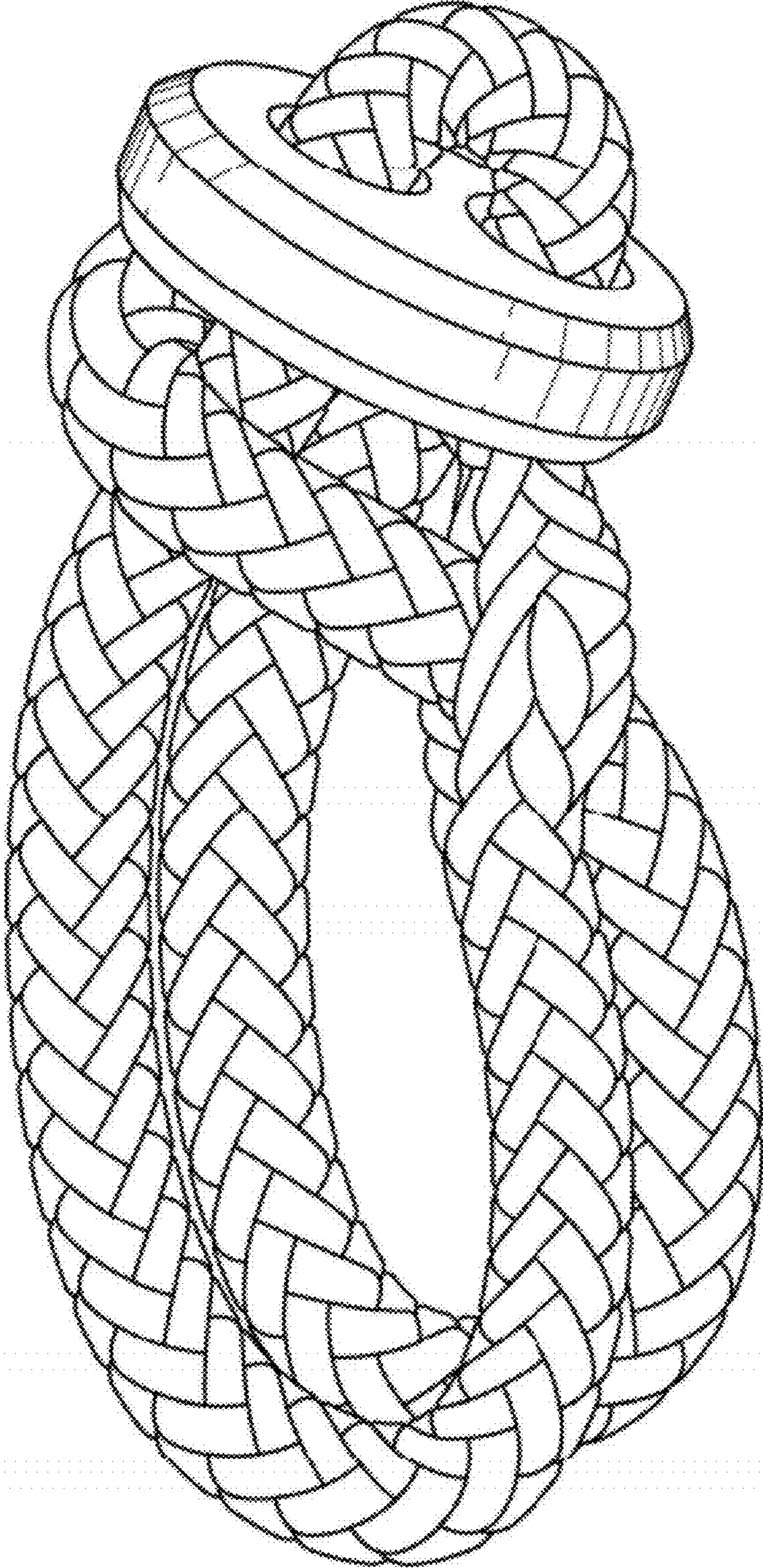

FIG. 1

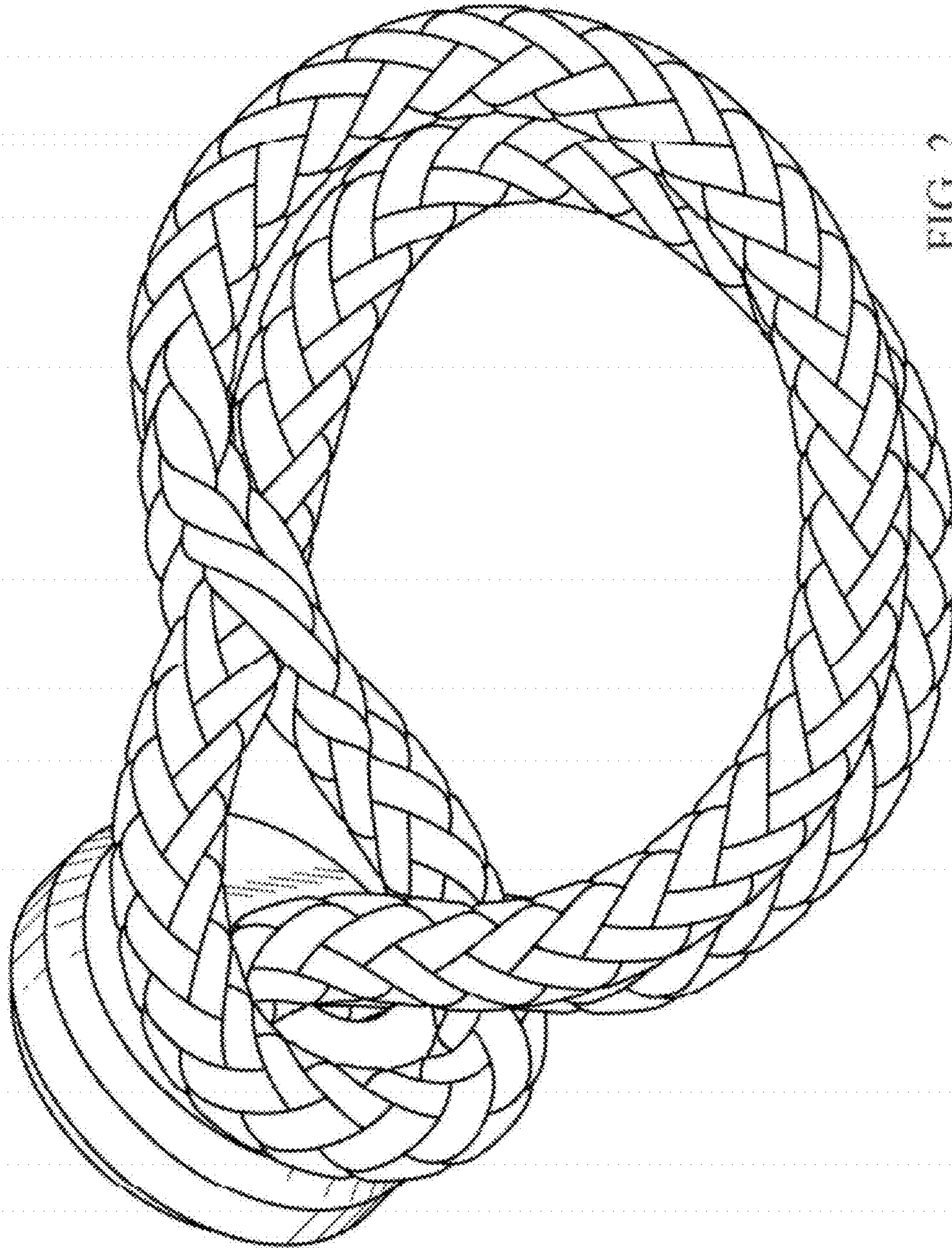

FIG. 2

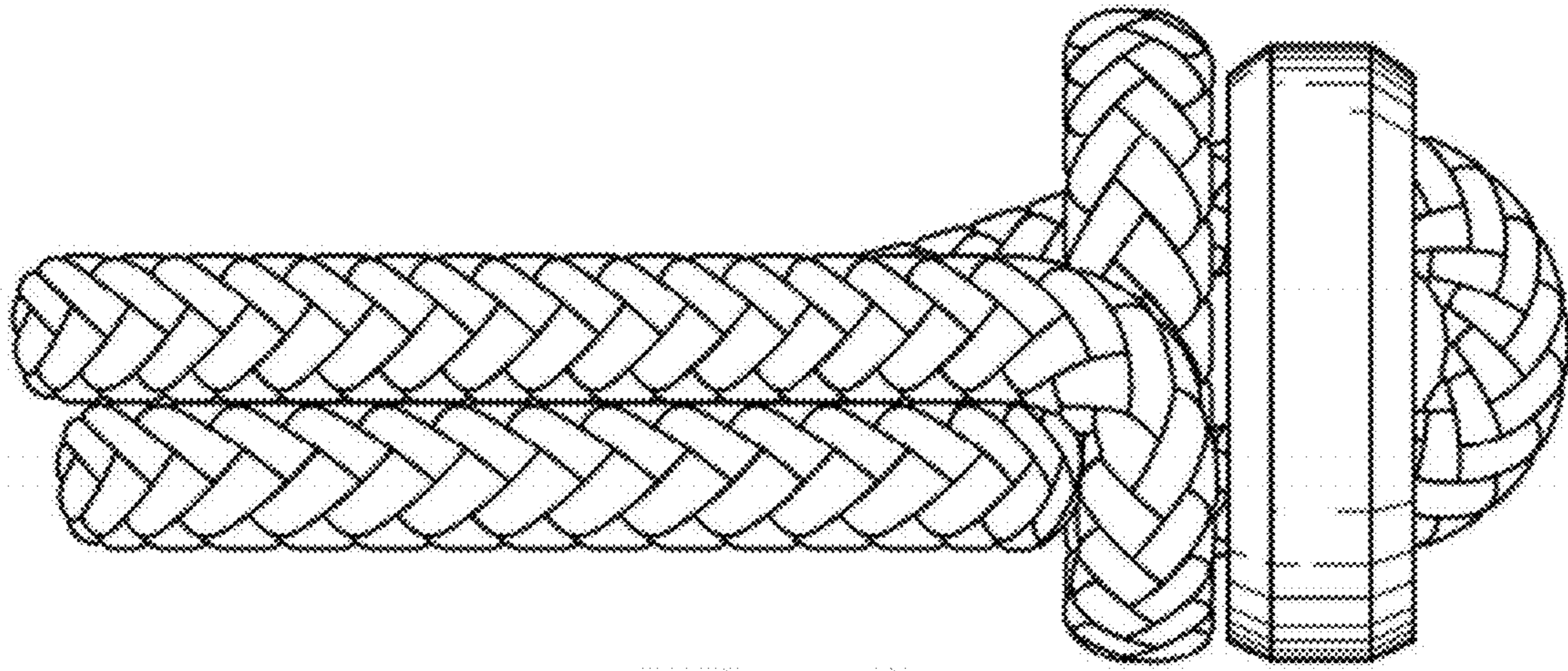

Fig. 3

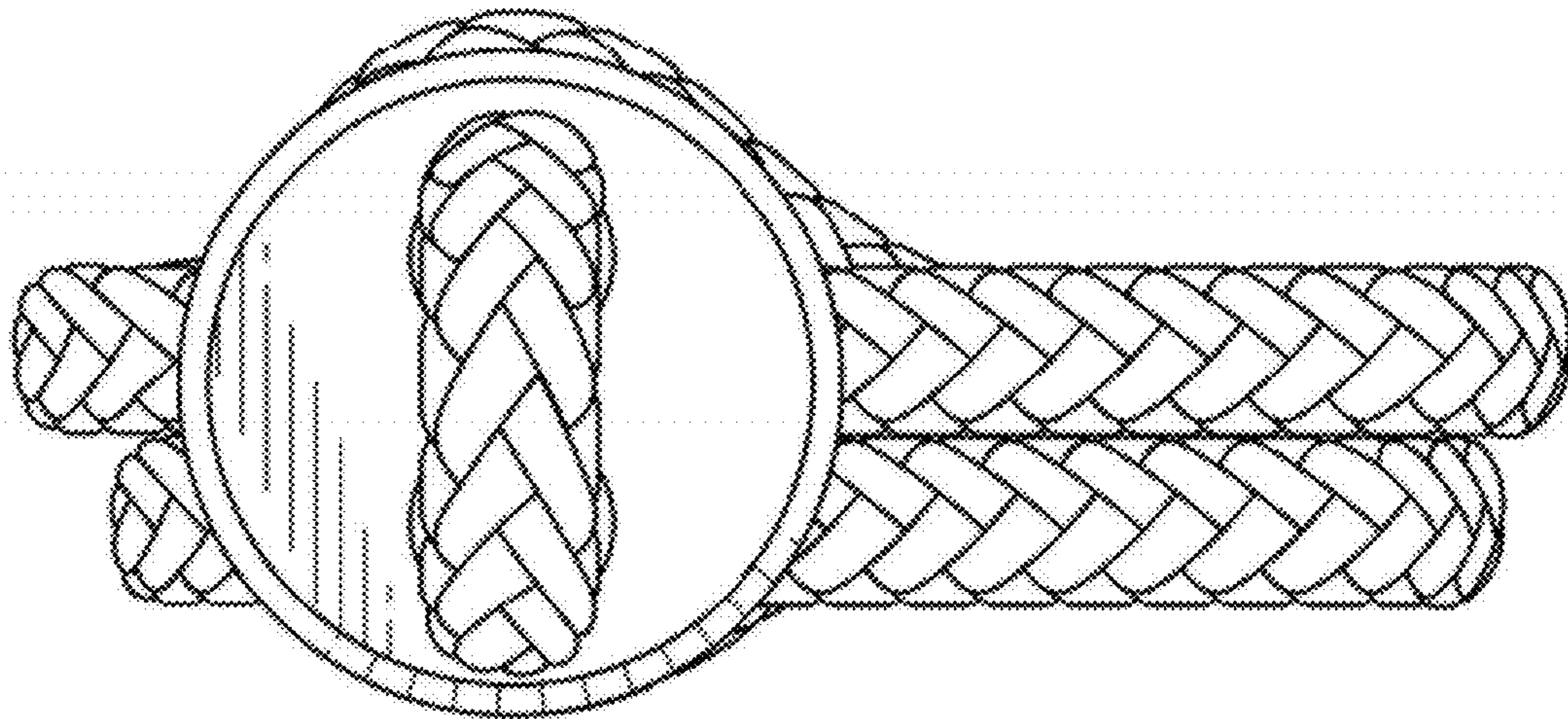

Fig. 4

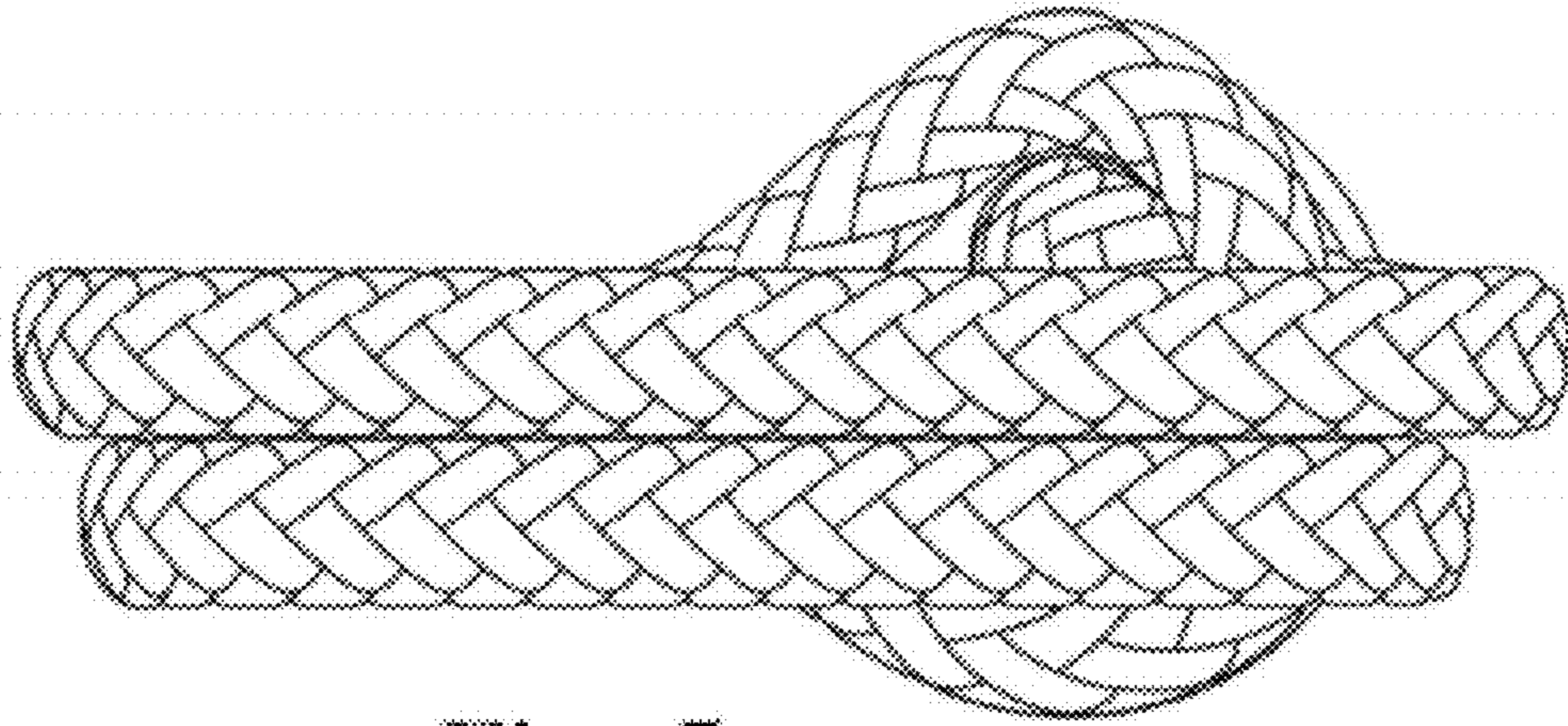

Fig. 5

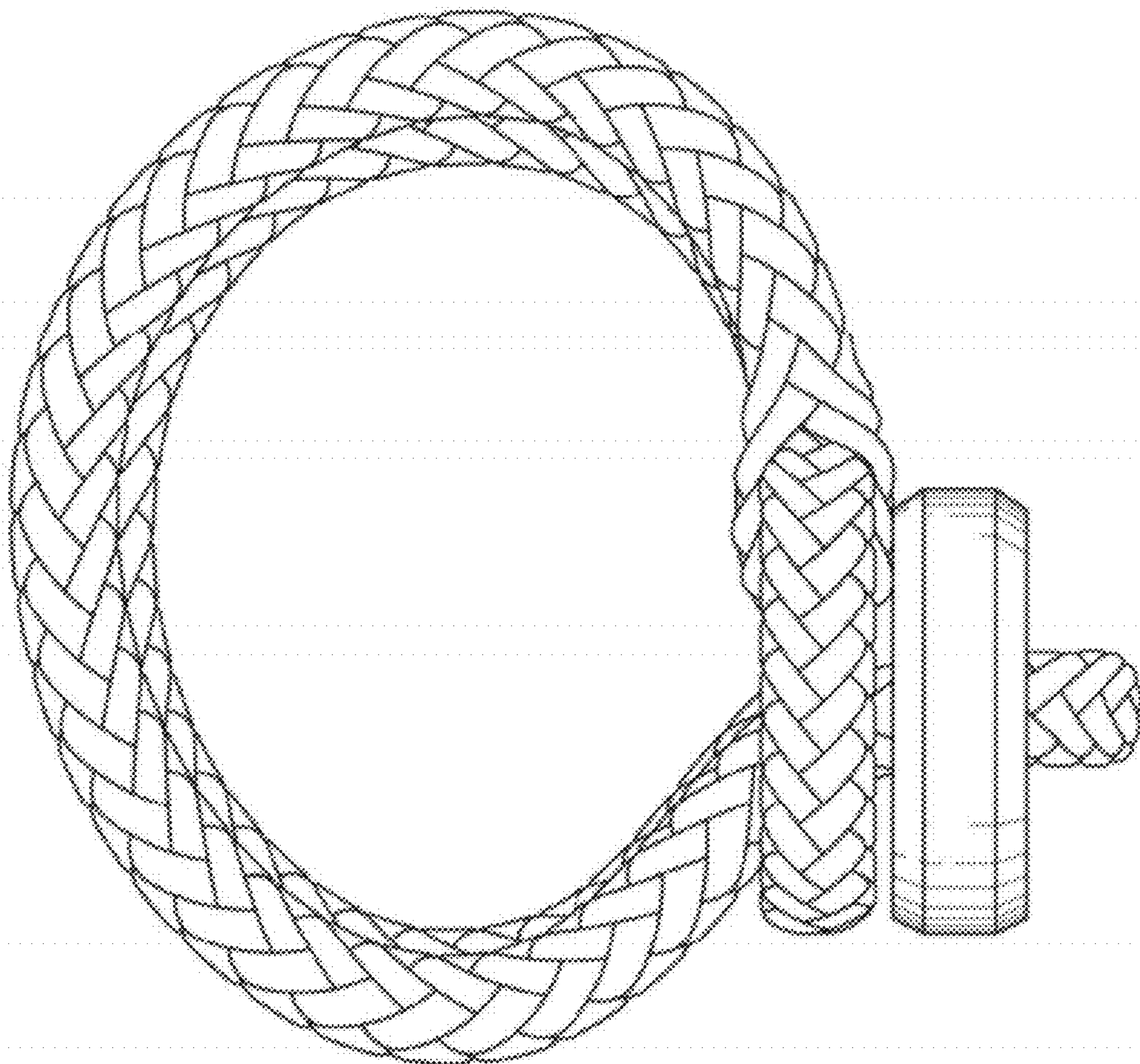

Fig. 6

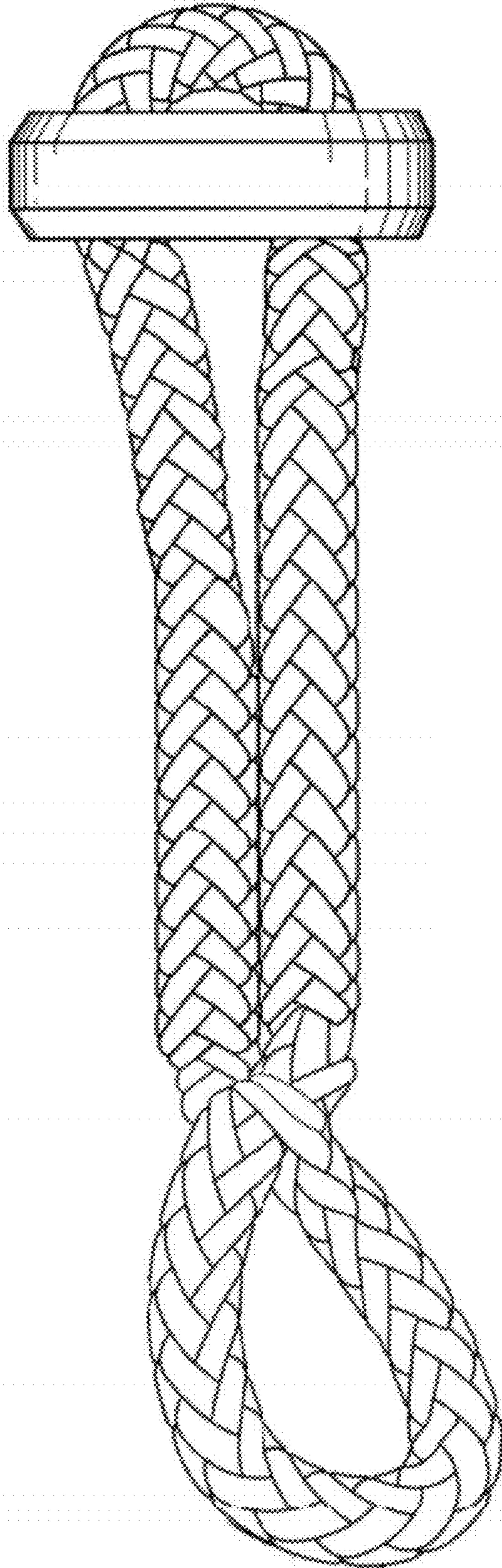

FIG. 7