



US00D657199S

(12) **United States Design Patent**
Chen

(10) **Patent No.:** **US D657,199 S**

(45) **Date of Patent:** **** Apr. 10, 2012**

(54) **SUPPORTING FRAME FOR SUPPORTING CUP-LIKE OBJECTS**

(76) Inventor: **Fang-Yin Chen**, Taichung Hsien (TW)

(**) Term: **14 Years**

(21) Appl. No.: **29/393,350**

(22) Filed: **Jun. 2, 2011**

(51) **LOC (9) Cl.** **07-06**

(52) **U.S. Cl.** **D7/600.1**

(58) **Field of Classification Search** D7/600.1-600.4,
D7/701-708; D6/512-517, 567, 552, 553,
D6/535; 211/49.1, 71.01, 72, 86.01, 87.01,
211/88.03, 89.01, 94.01, 113; 248/309.1
See application file for complete search history.

(56) **References Cited**

U.S. PATENT DOCUMENTS

3,788,487 A * 1/1974 Dawson 211/49.1
D233,120 S * 10/1974 Dawson D7/701
D247,256 S * 2/1978 Kevin D3/259
D248,128 S * 6/1978 Mineo D6/514
5,590,813 A * 1/1997 Abramczyk 221/197

D478,737 S * 8/2003 Sparkowski D6/408
D486,682 S * 2/2004 Zins et al. D6/535
D538,608 S * 3/2007 Goodman et al. D7/704
D625,534 S * 10/2010 Chen D7/619.1

* cited by examiner

Primary Examiner — Terry Wallace

(57) **CLAIM**

The ornamental design for a supporting frame for supporting cup-like objects, as shown and described.

DESCRIPTION

FIG. 1 is a perspective view of a supporting frame for supporting cup-like objects showing my new design
FIG. 2 is a front elevational view thereof
FIG. 3 is a rear elevational view thereof.
FIG. 4 is a left side view thereof
FIG. 5 is a right side view thereof
FIG. 6 is a top plan view thereof
FIG. 7 is a bottom plan view thereof; and,
FIG. 8 is a perspective view showing the application of the present invention, where those indicated by dashed lines are not claimed.

1 Claim, 5 Drawing Sheets

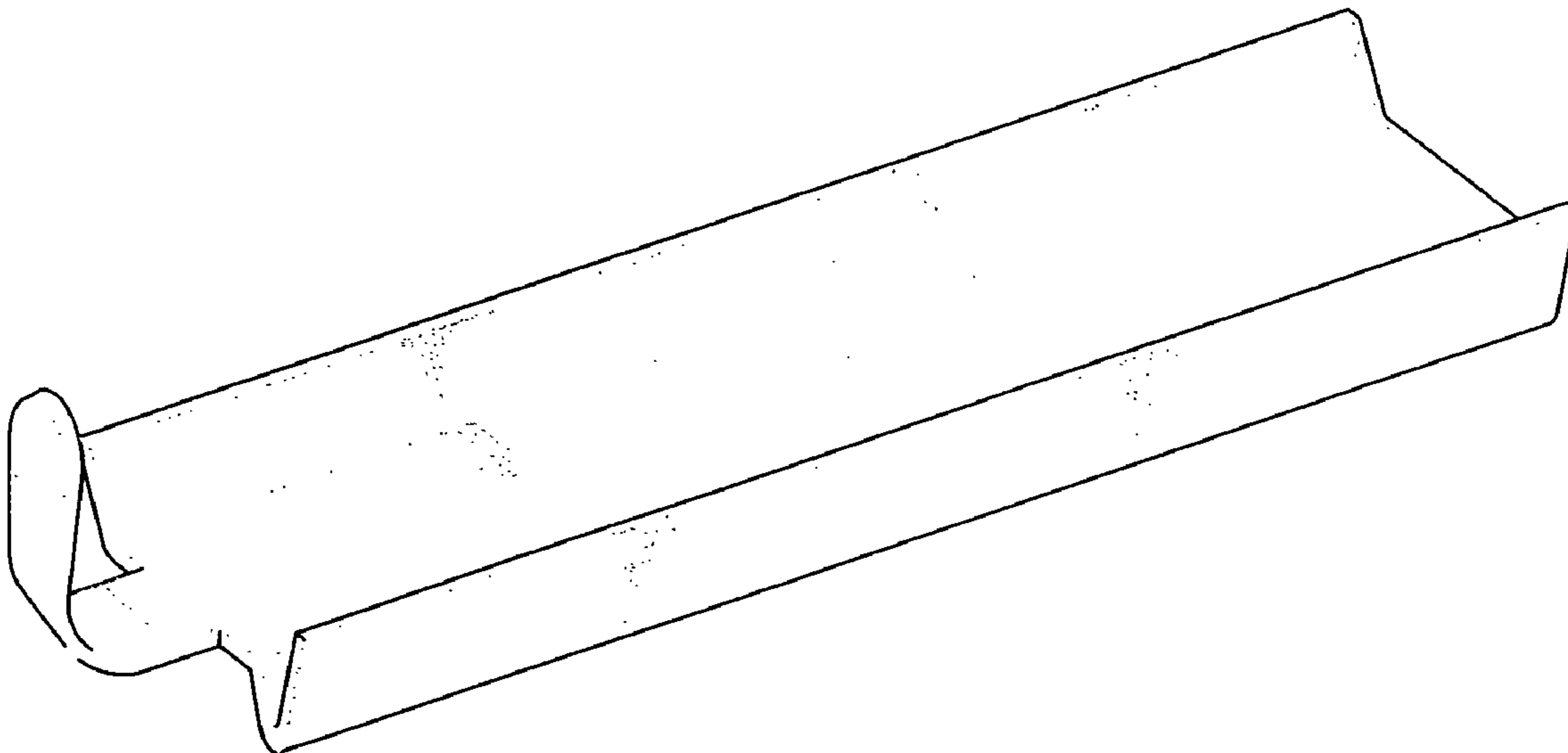

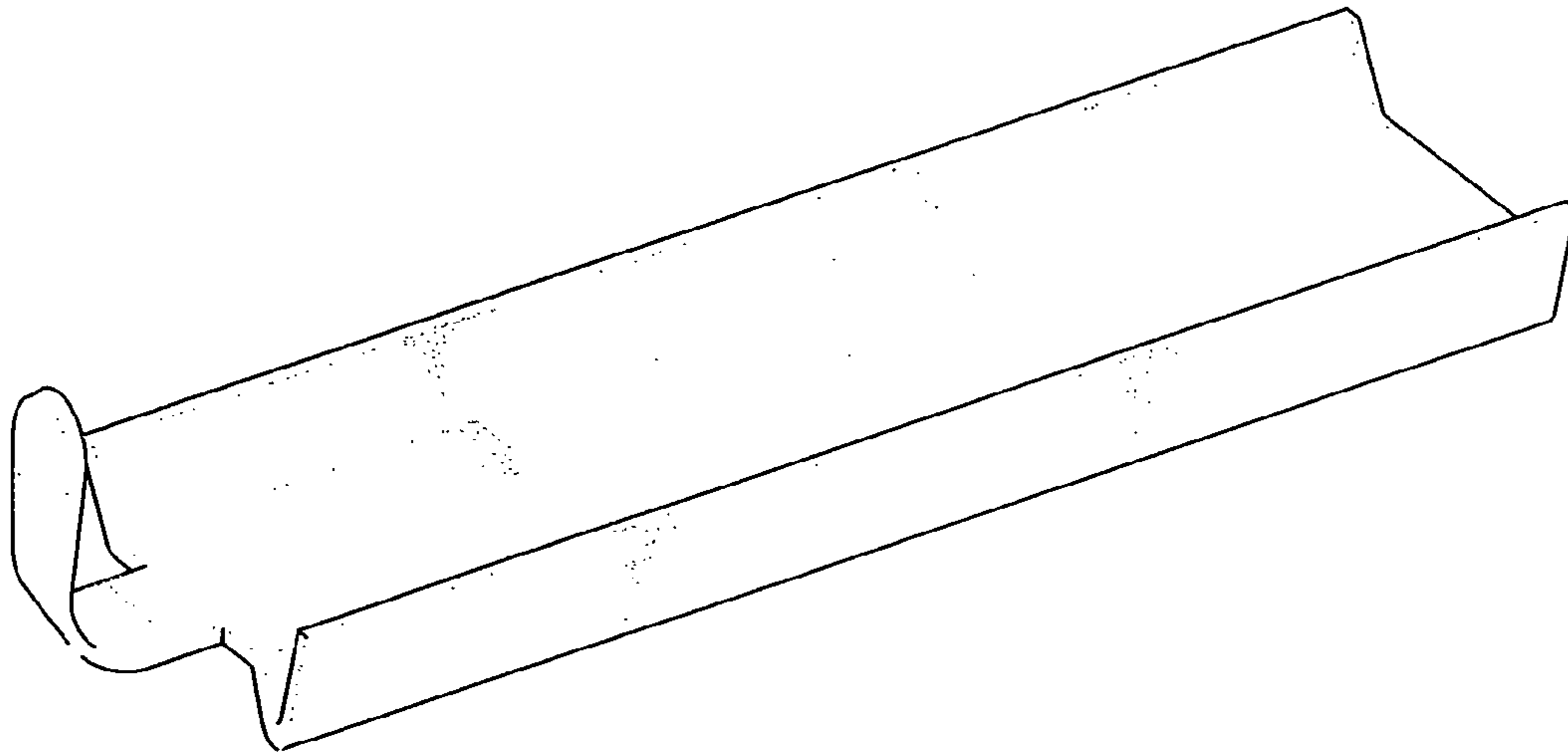

FIG. 1

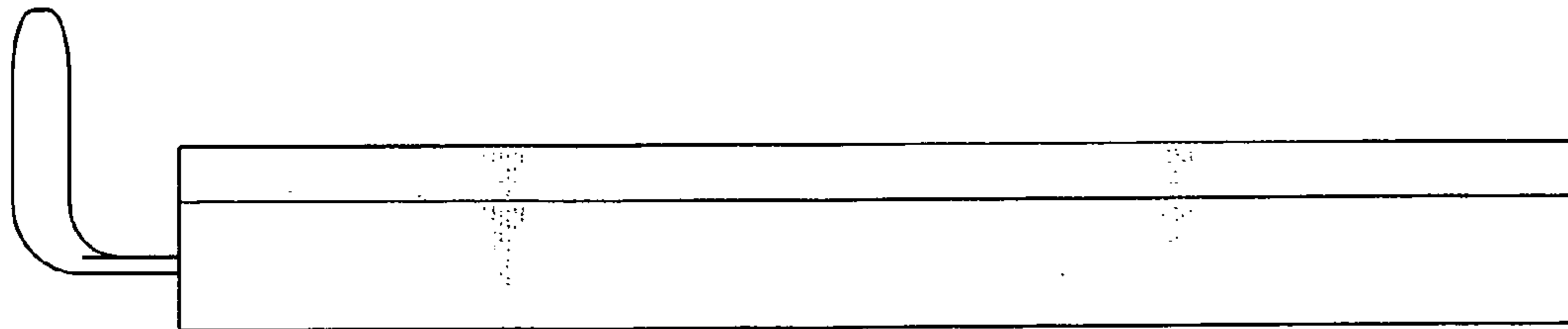

FIG. 2

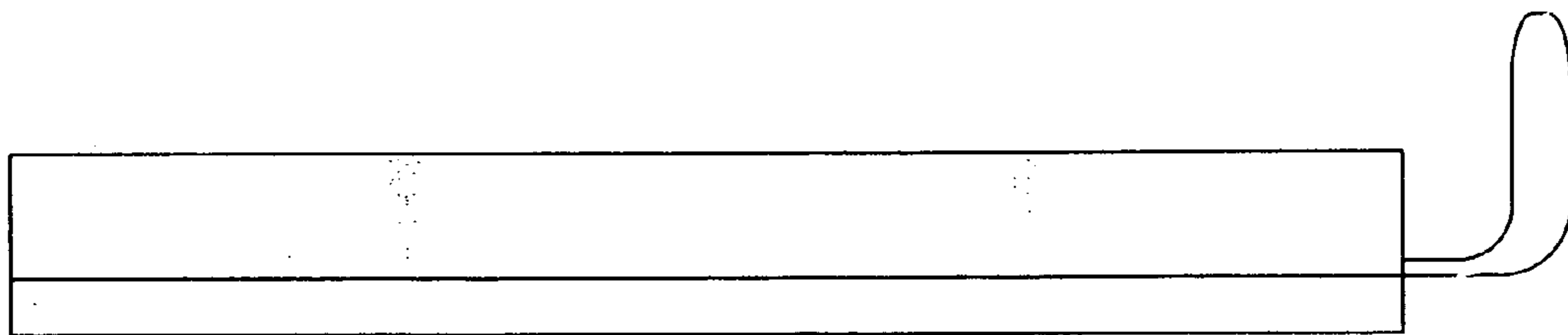

FIG. 3

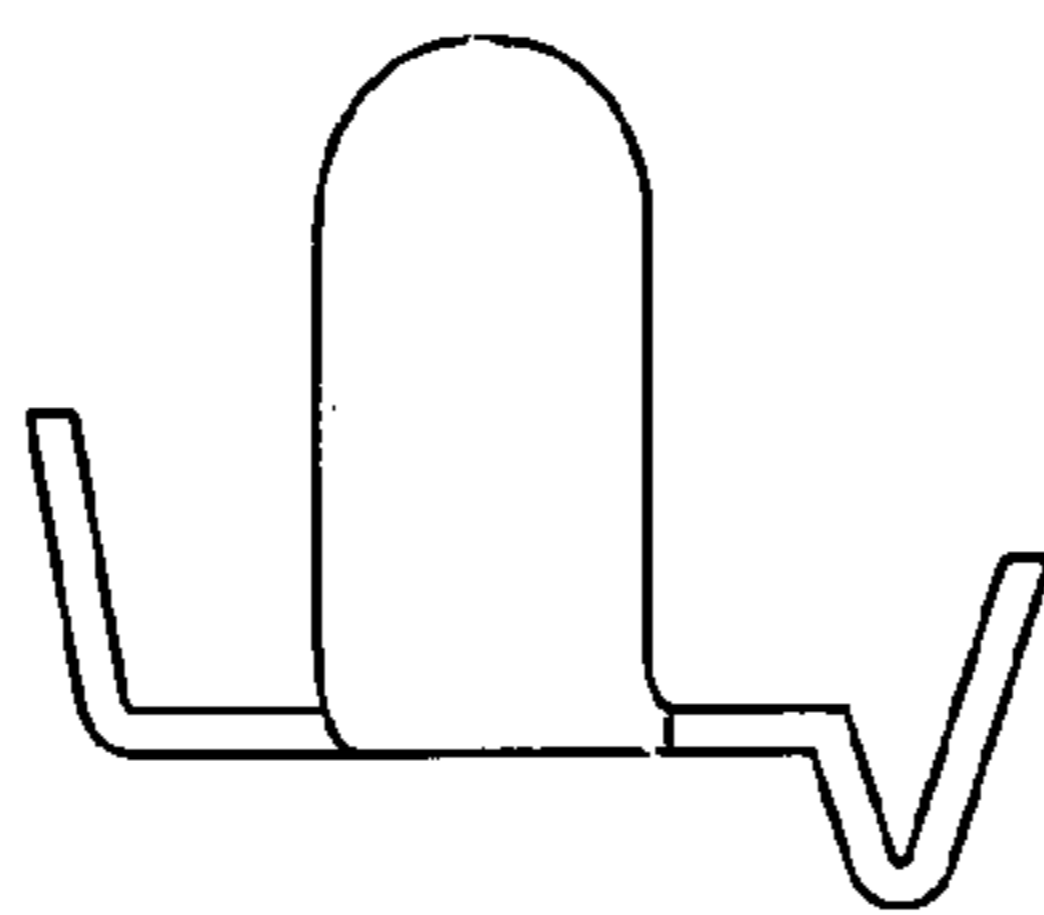

FIG. 4

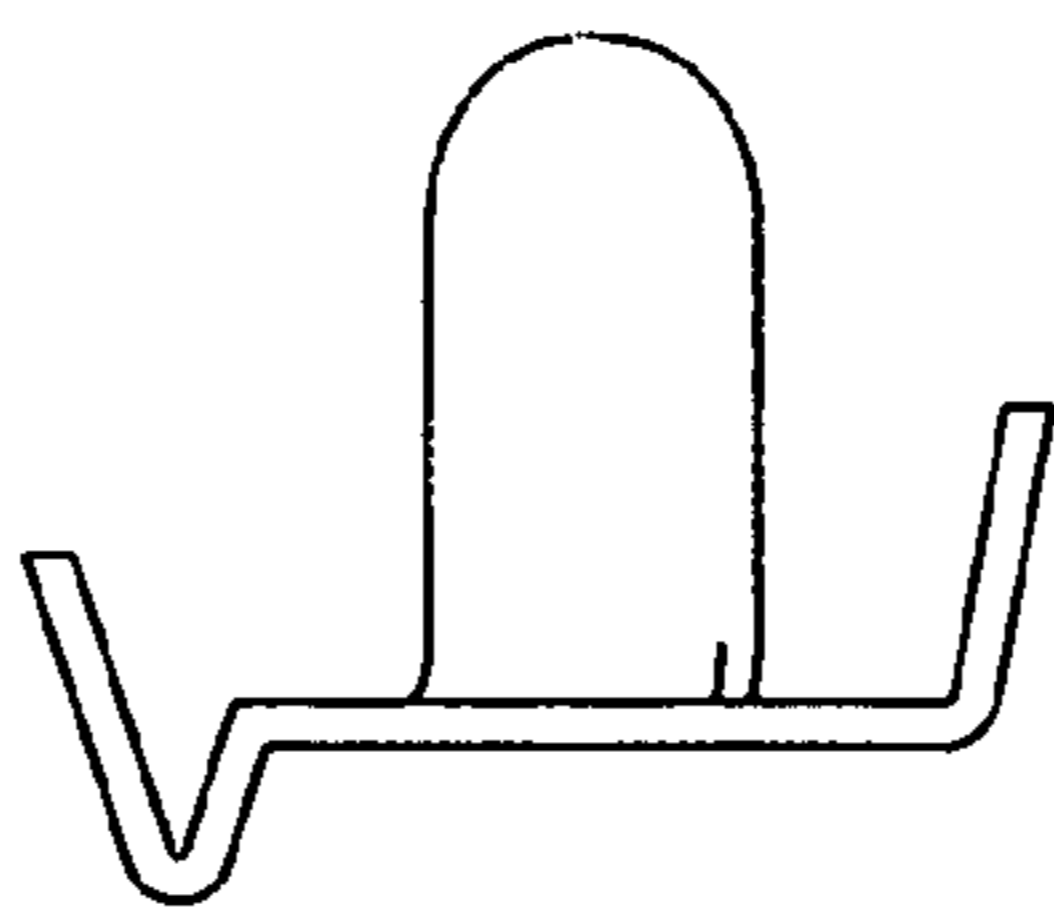

FIG. 5

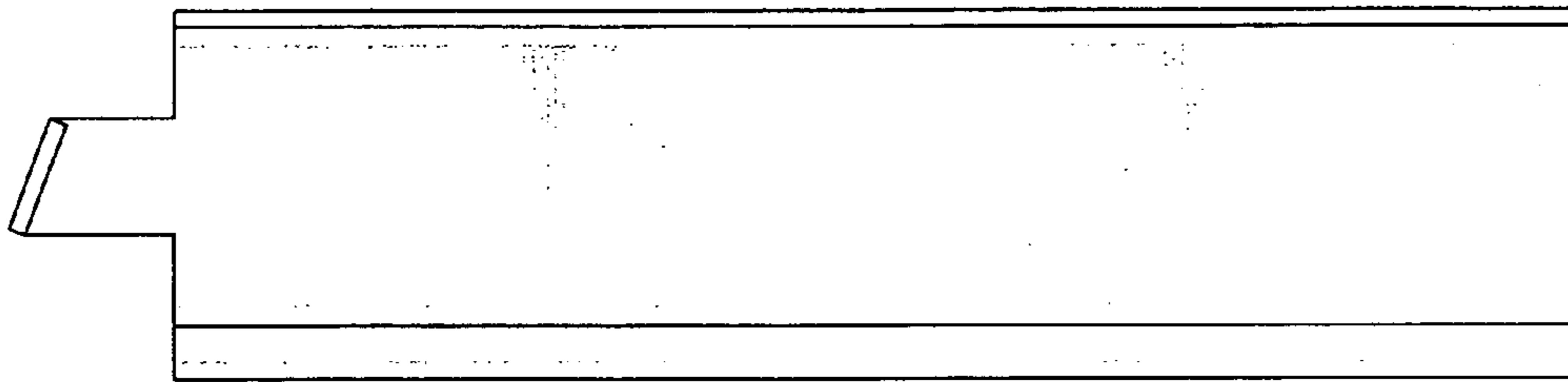

FIG. 6

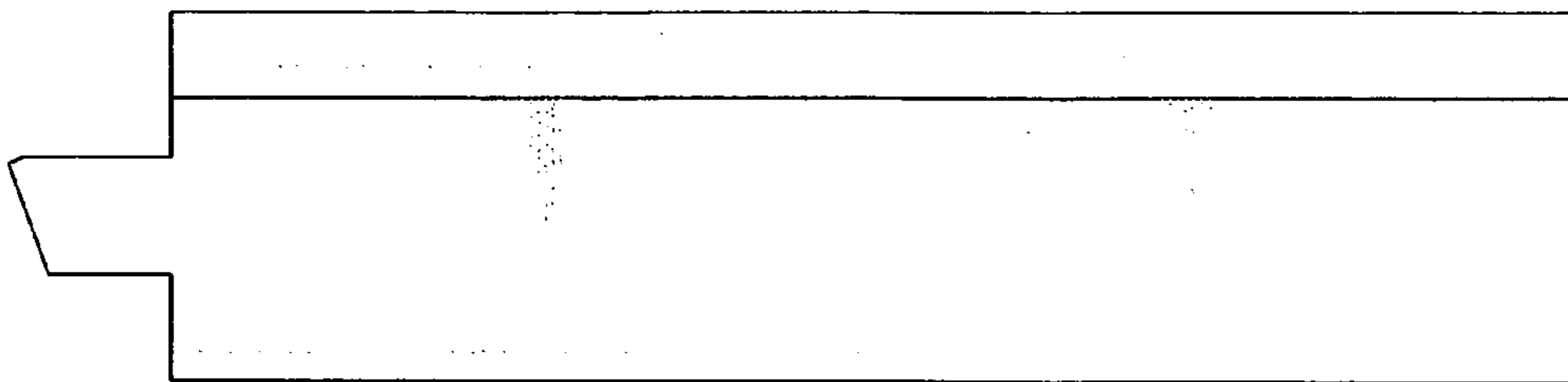

FIG. 7

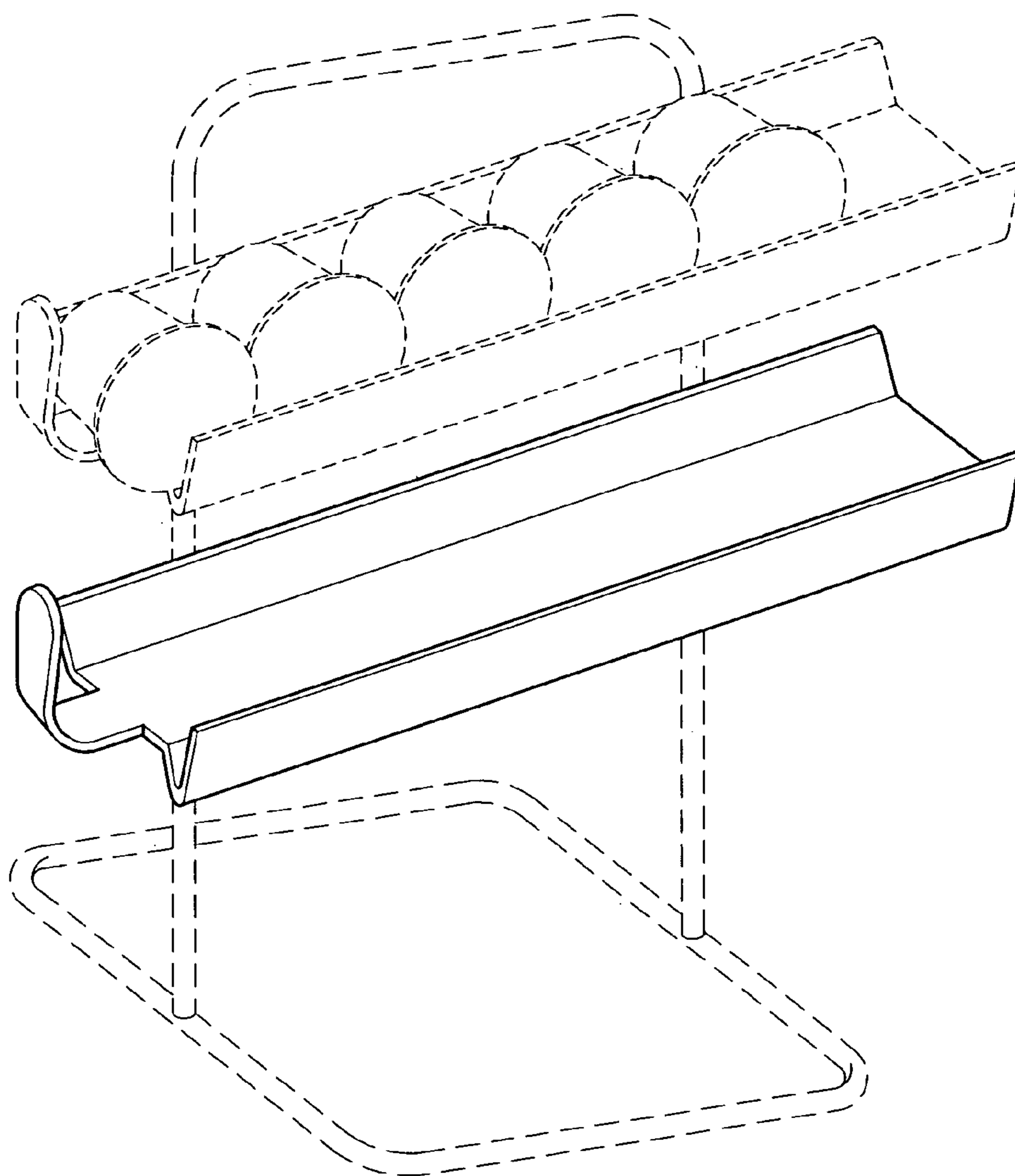

FIG. 8