



US00D657185S

(12) **United States Design Patent**
Segato

(10) **Patent No.:** **US D657,185 S**

(45) **Date of Patent:** **** Apr. 10, 2012**

(54) **OVEN**

(75) Inventor: **Fabio Segato**, Vignola (IT)

(73) Assignee: **Angel Po Grandi Cucine—Societa' per azioni** (IT)

(**) Term: **14 Years**

(21) Appl. No.: **29/390,281**

(22) Filed: **Apr. 22, 2011**

Related U.S. Application Data

(62) Division of application No. 29/367,089, filed on Aug. 3, 2010.

(51) **LOC (9) Cl.** **07-02**

(52) **U.S. Cl.** **D7/348**

(58) **Field of Classification Search** D7/323,
D7/340-348, 404-409; 126/39 B, 211, 217-218,
126/214 C, 214 R, 215-216, 152 R; 219/460.1,
219/506

See application file for complete search history.

(56) **References Cited**

U.S. PATENT DOCUMENTS

D230,341 S	2/1974	Waligorski	
D271,268 S	11/1983	Salzmann et al.	
D318,775 S	8/1991	Bonnet et al.	
D343,090 S	1/1994	Connell	
D523,685 S	6/2006	Jung et al.	
D560,960 S	2/2008	Hillmann et al.	
D567,571 S	4/2008	Hillmann et al.	
D568,089 S	5/2008	Hillmann et al.	
D573,400 S *	7/2008	Olson	D7/339
D580,698 S	11/2008	Kim et al.	
D627,593 S *	11/2010	Lee et al.	D7/340

* cited by examiner

Primary Examiner — Ralf Seifert

(74) *Attorney, Agent, or Firm* — Laubscher & Laubscher, P.C.

(57) **CLAIM**
The ornamental design for an oven, as shown.

DESCRIPTION

FIG. 1 is a front perspective view of the invention illustrating the first embodiment of my design;
 FIG. 2 is a front elevation view of the first embodiment of my design;
 FIG. 3 is a rear elevation view of the first embodiment of my design;
 FIG. 4 is a left side elevation view of the first embodiment of my design;
 FIG. 5 is a right side elevation view of the first embodiment of my design;
 FIG. 6 is a top elevation view of the first embodiment of my design;
 FIG. 7 is a bottom elevation view of the first embodiment of my design;
 FIG. 8 is a front perspective view of the invention illustrating a second embodiment of my design;
 FIG. 9 is a front elevation view of the second embodiment of my design;
 FIG. 10 is a rear elevation view of the second embodiment of my design;
 FIG. 11 is a left side elevation view of the second embodiment of my design;
 FIG. 12 is a right side elevation view of the second embodiment of my design;
 FIG. 13 is a top elevation view of the second embodiment of my design; and,
 FIG. 14 is a bottom elevation view of the second embodiment of my design.

The broken lines in FIGS. 2, 3, 5-7, 9, 10 and 12-14 are included for the purpose of illustrating portions of the claimed design that form no part of the claimed design.

1 Claim, 14 Drawing Sheets

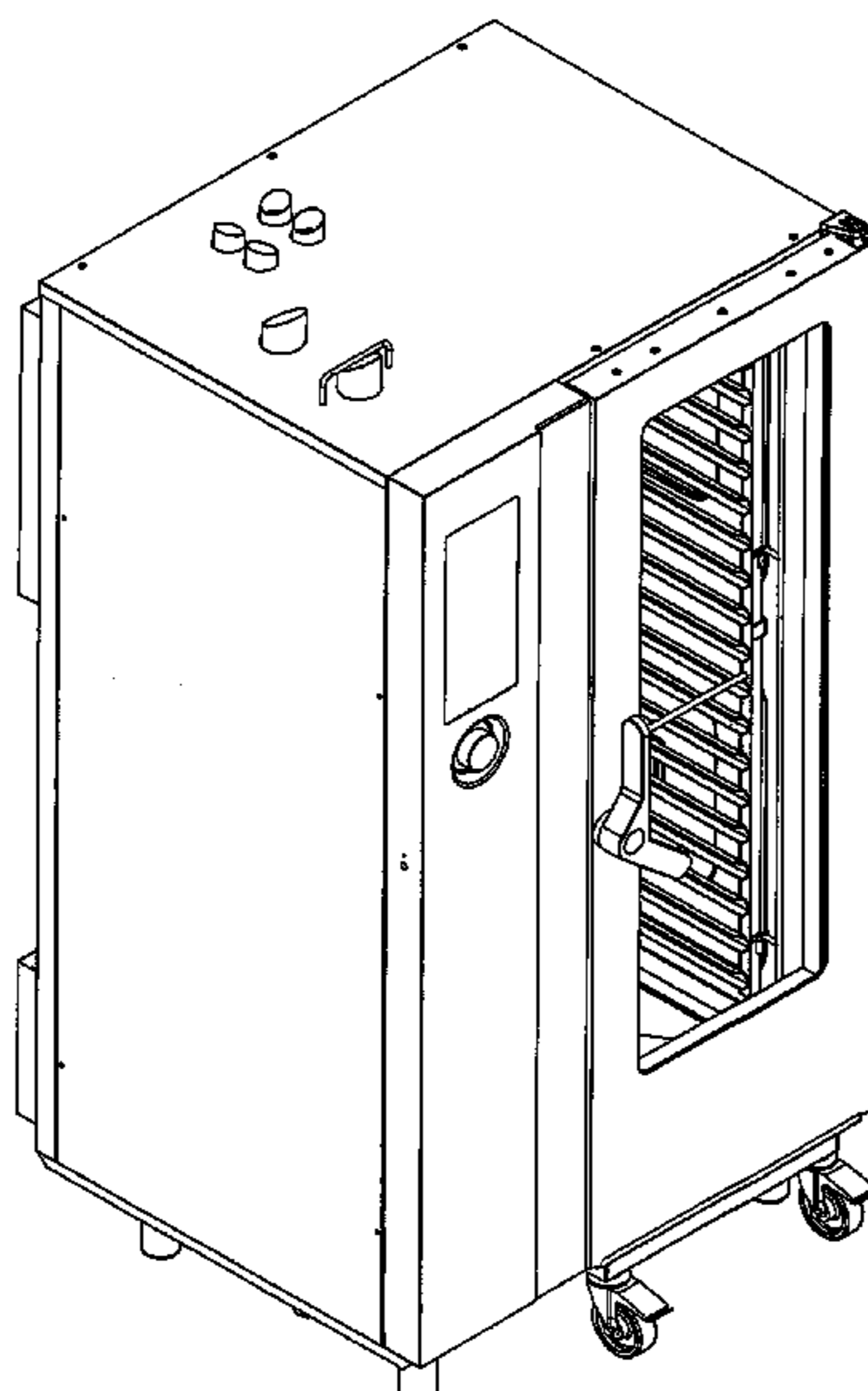

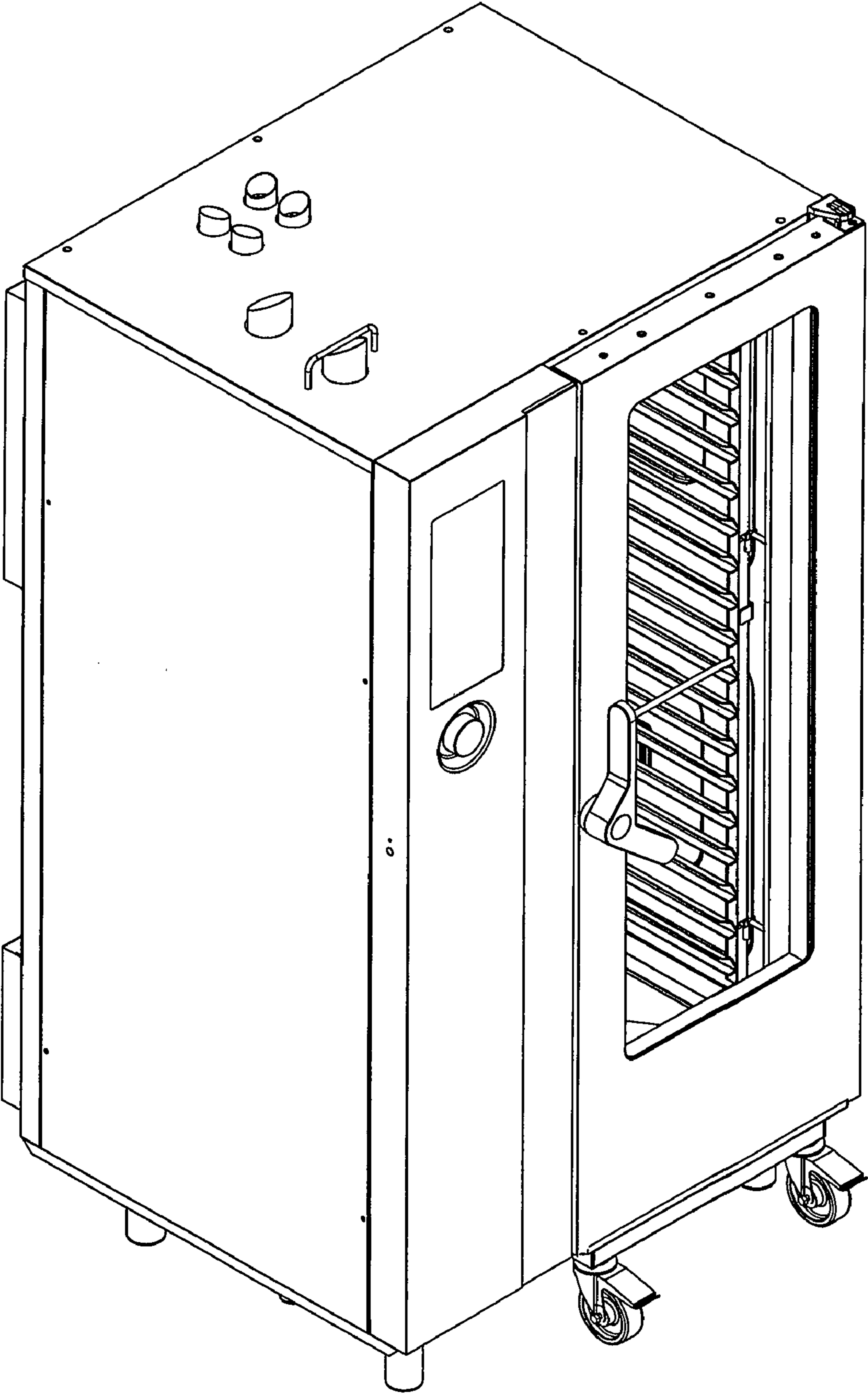

Fig. 1

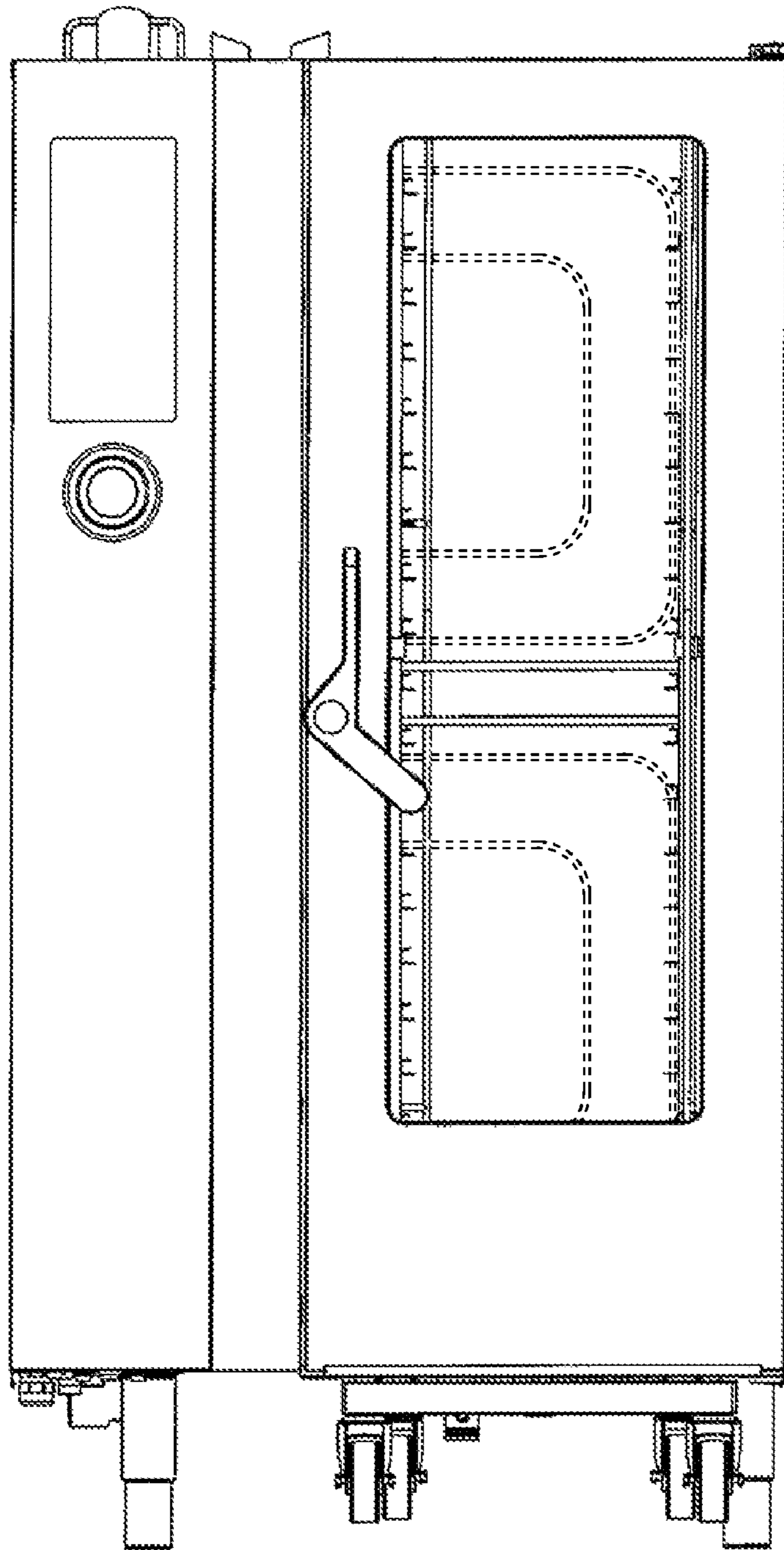

Fig. 2

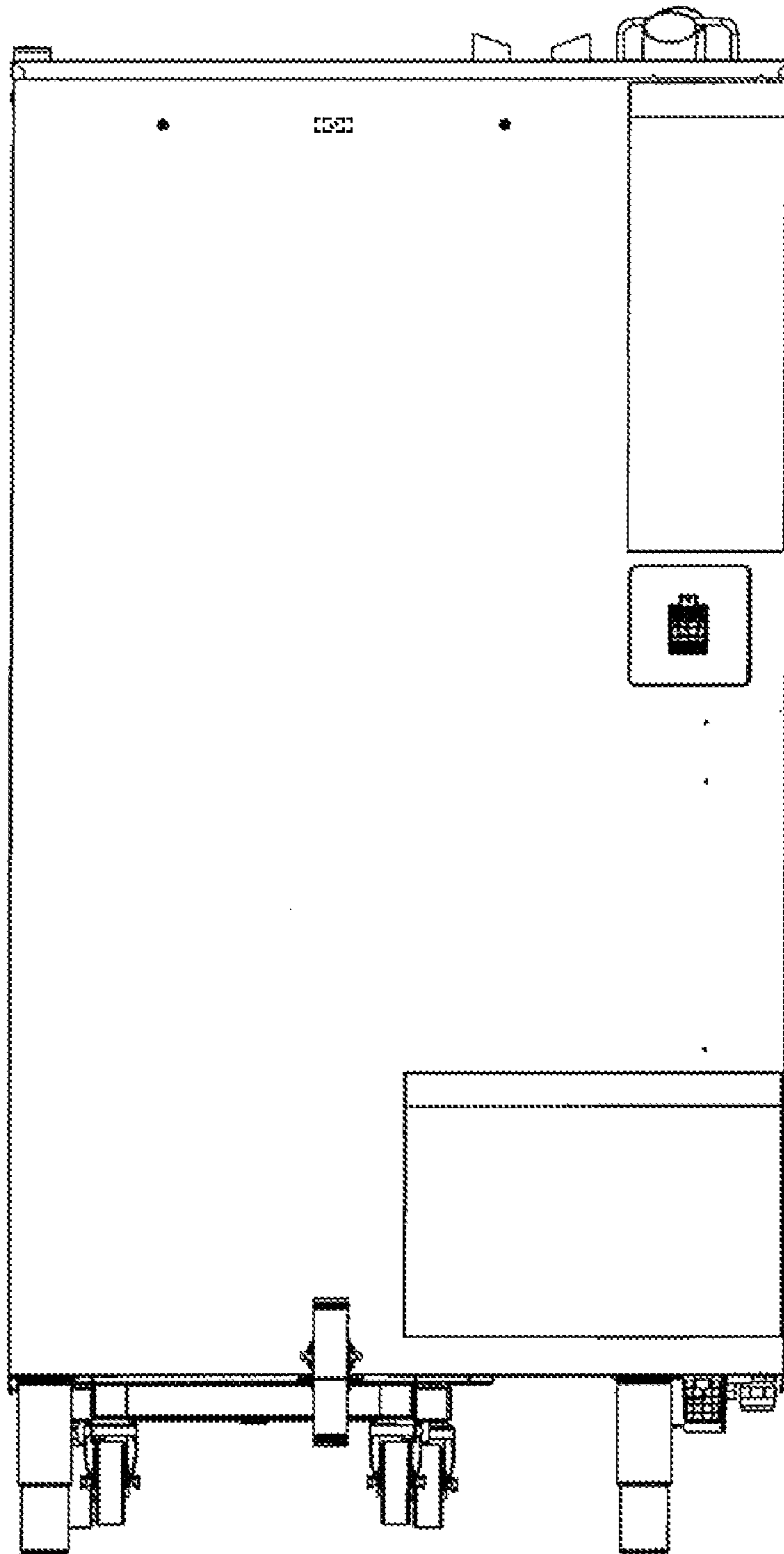

Fig. 3

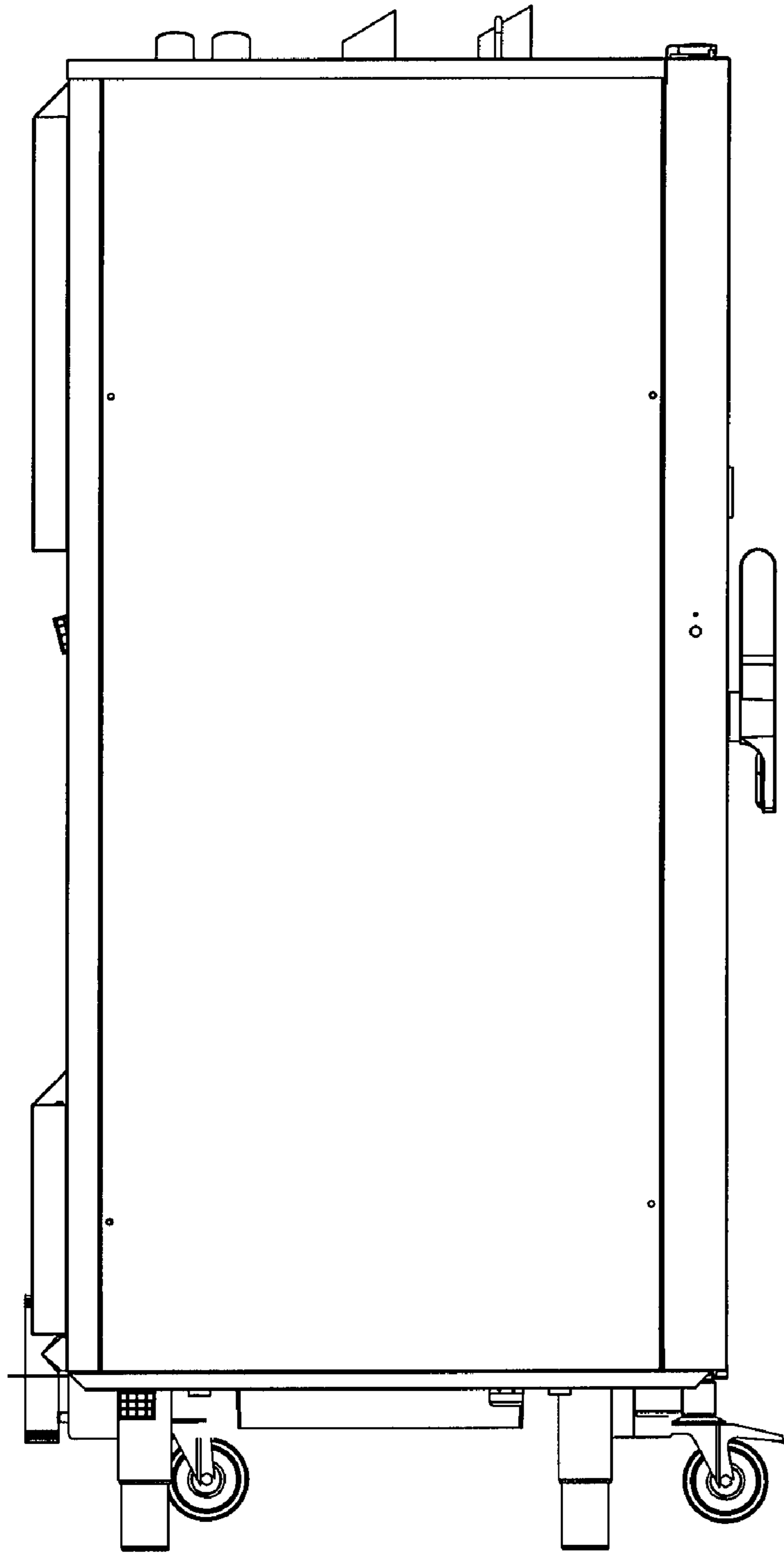

Fig. 4

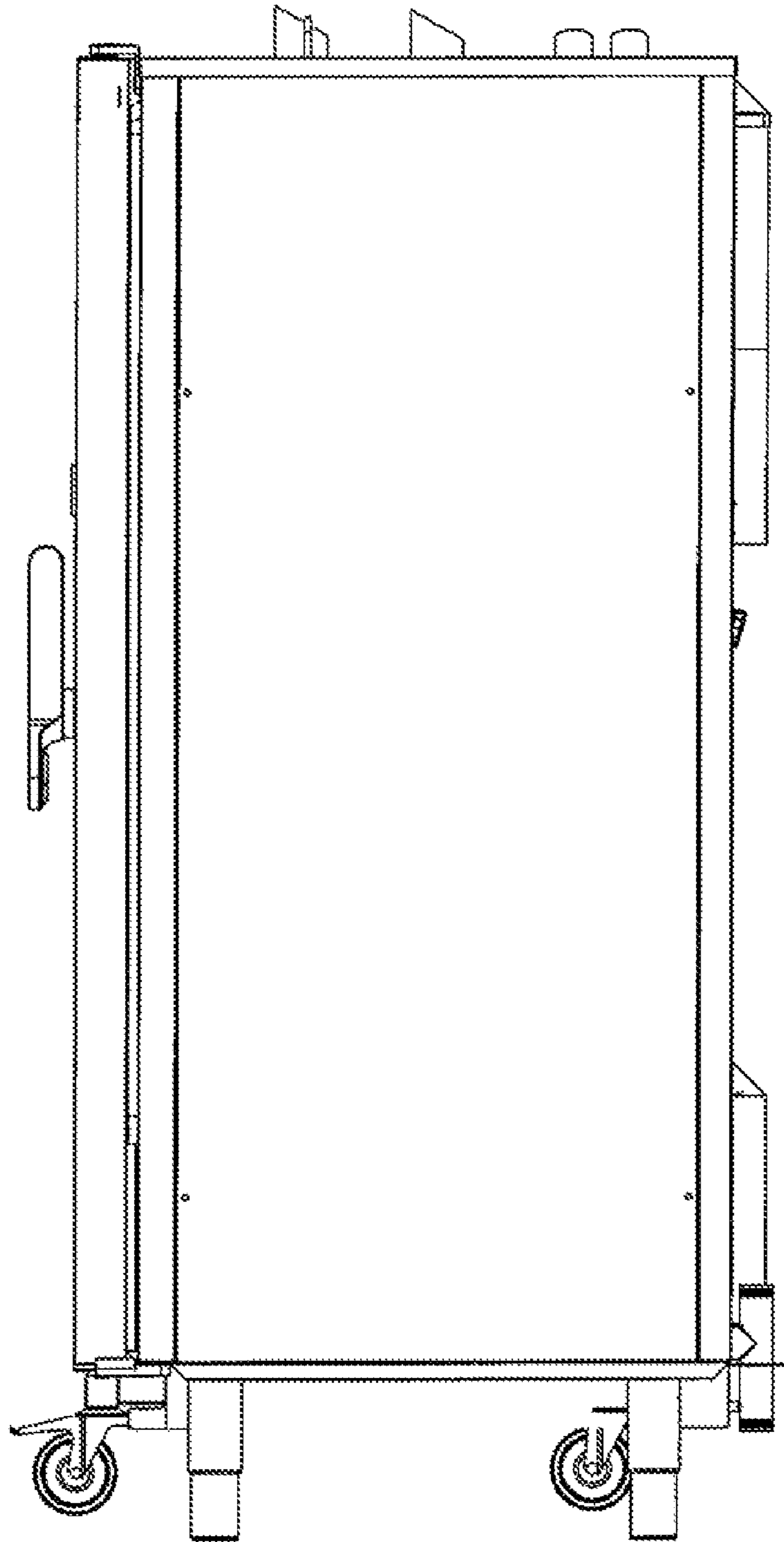

Fig. 5

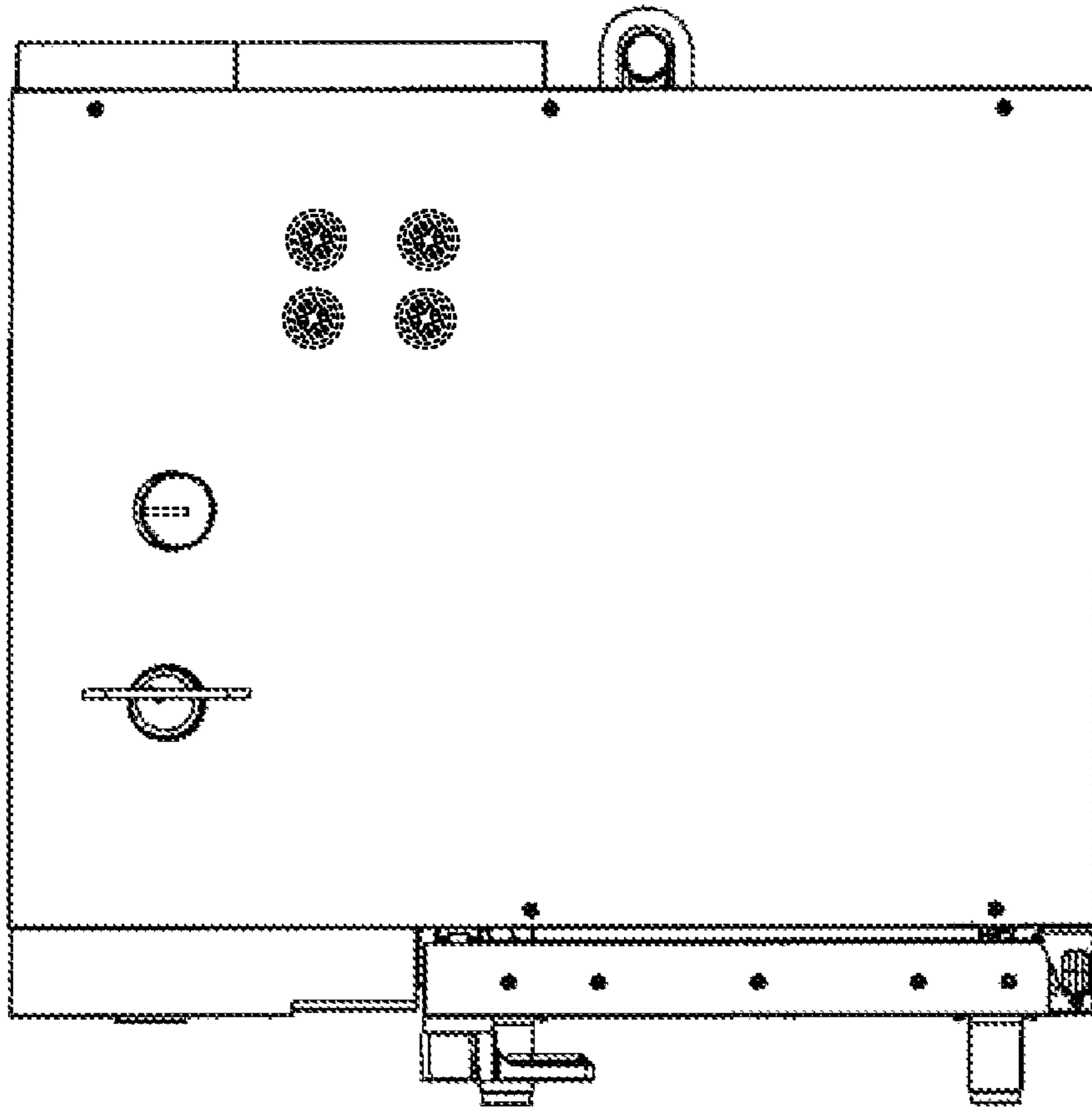

Fig. 6

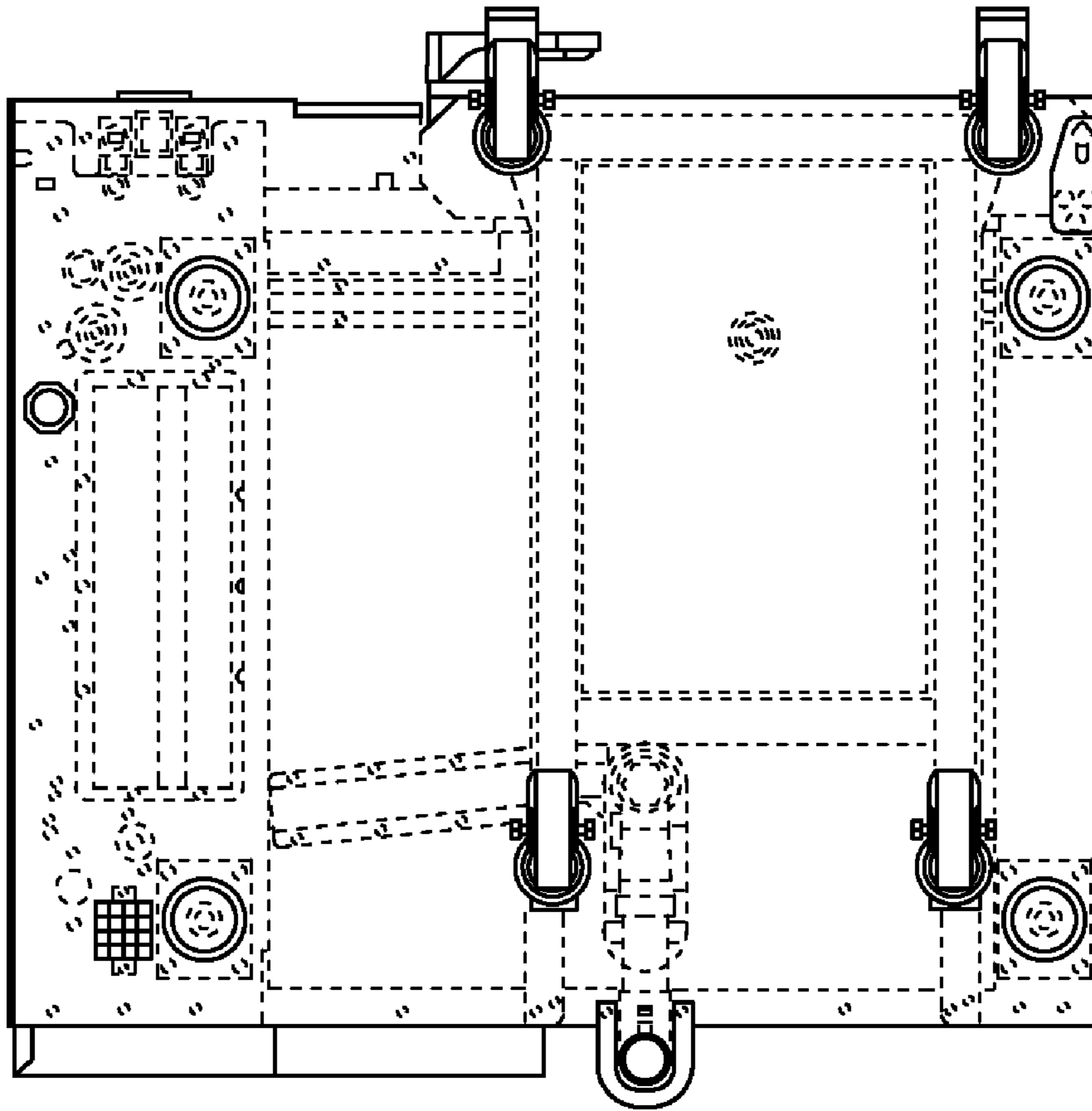

Fig. 7

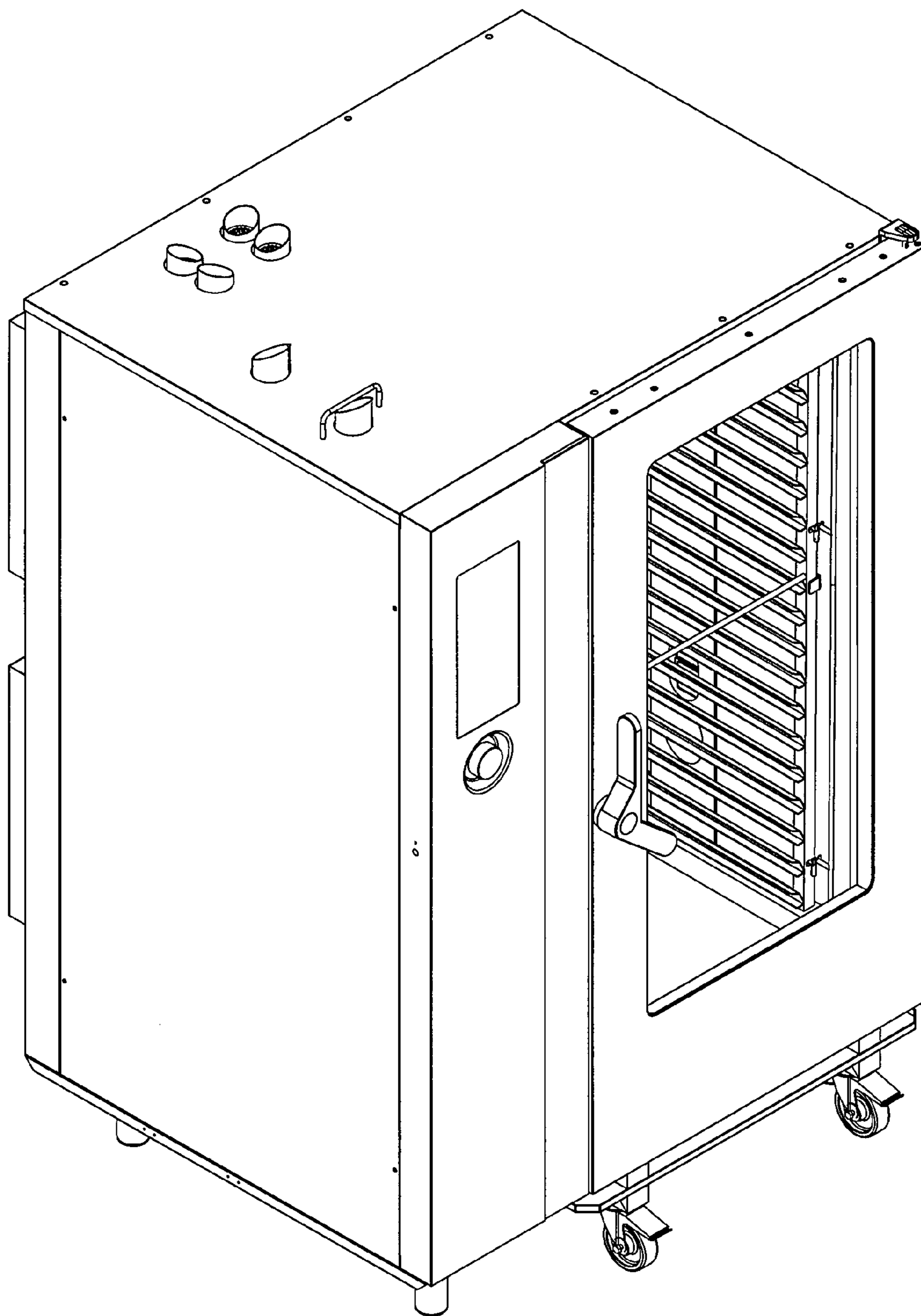

Fig. 8

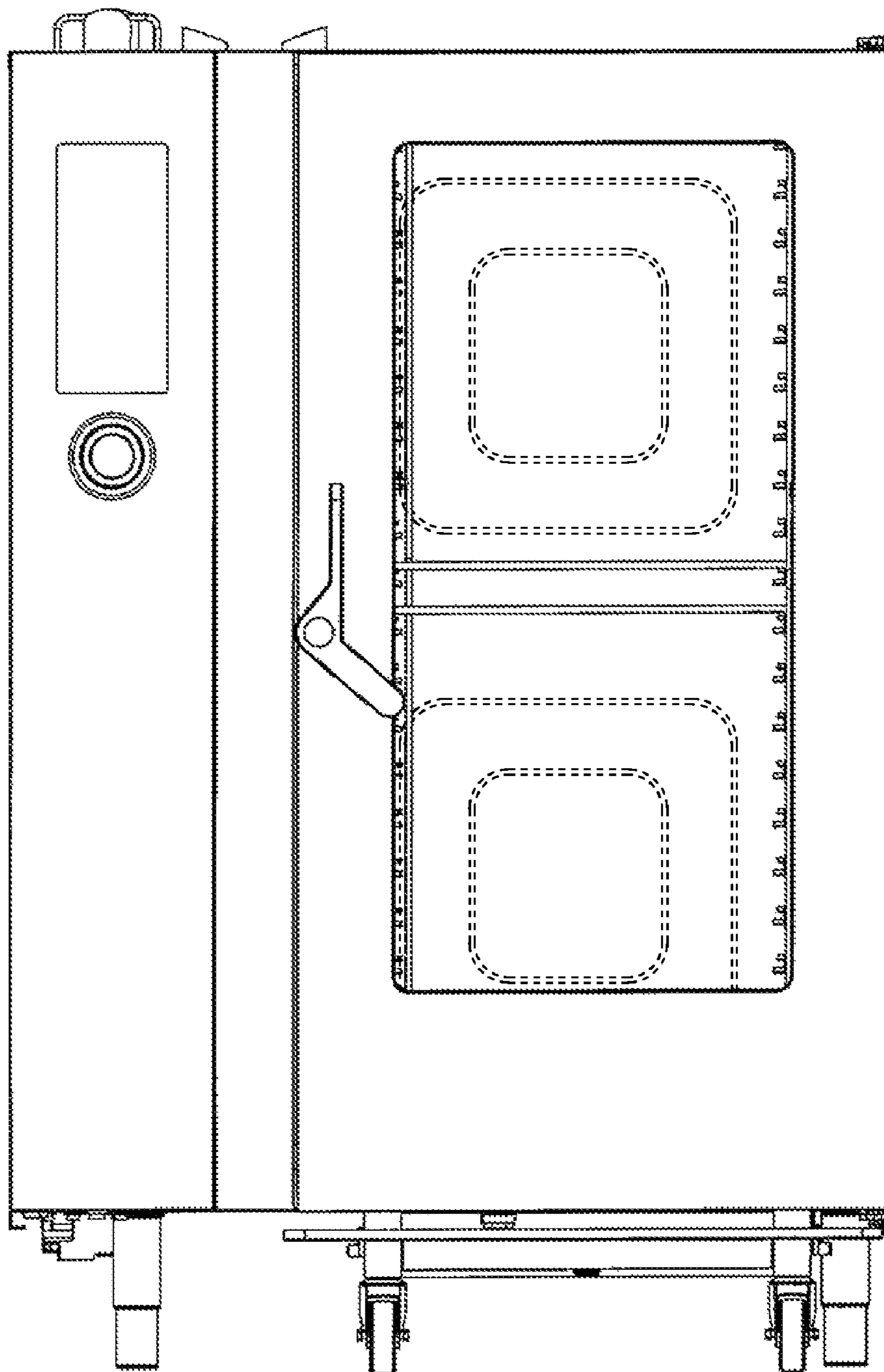

Fig. 9

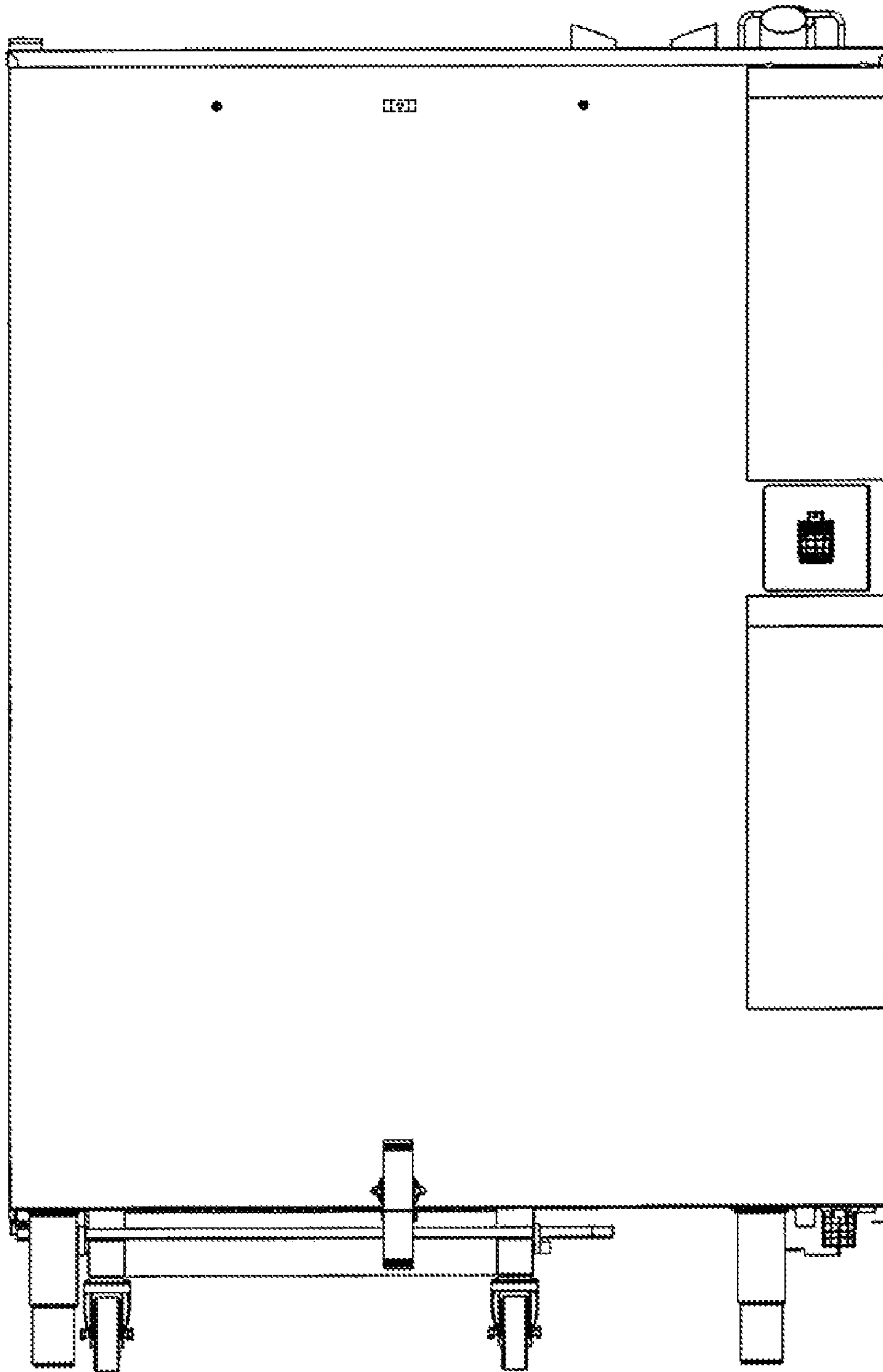

Fig. 10

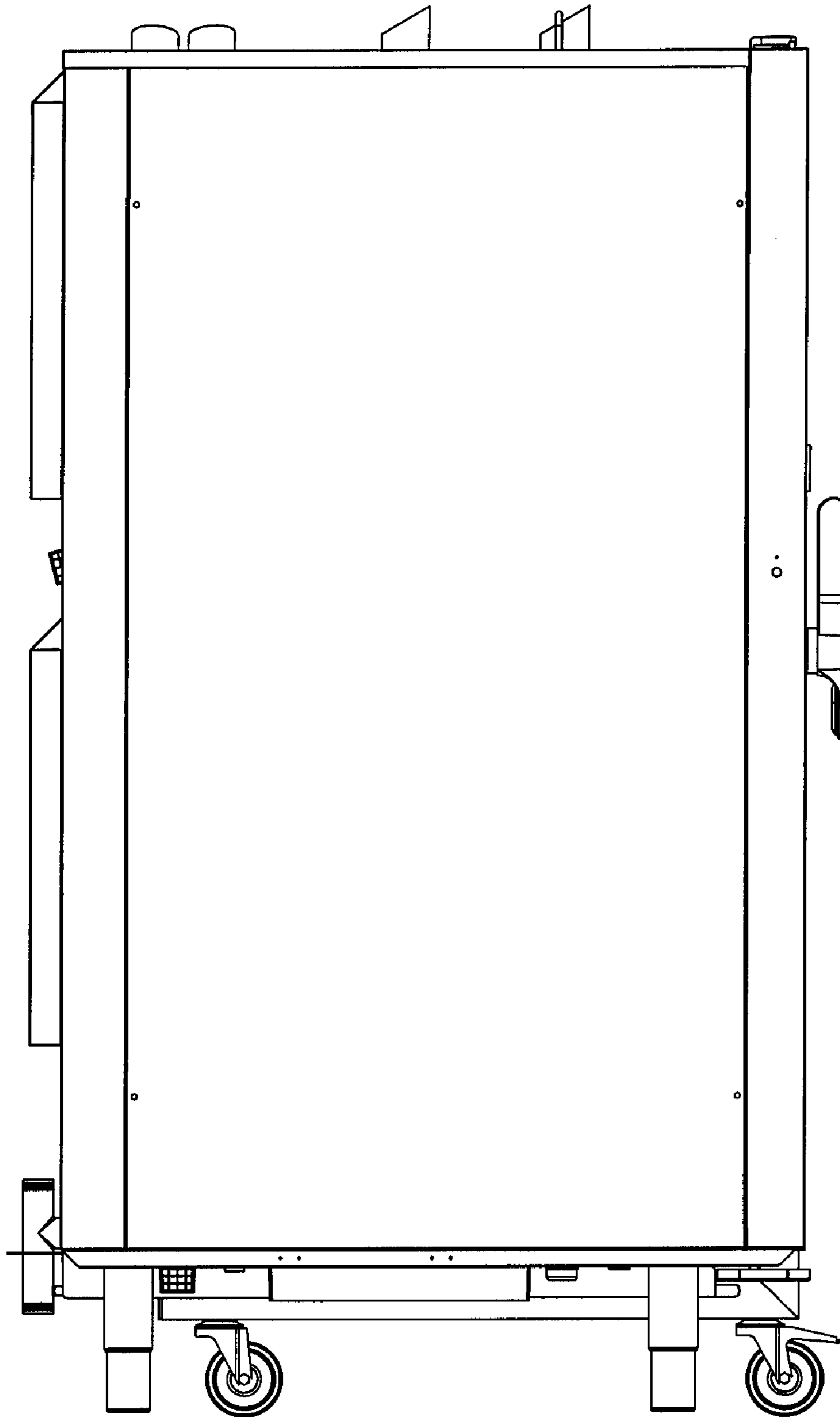

Fig. 11

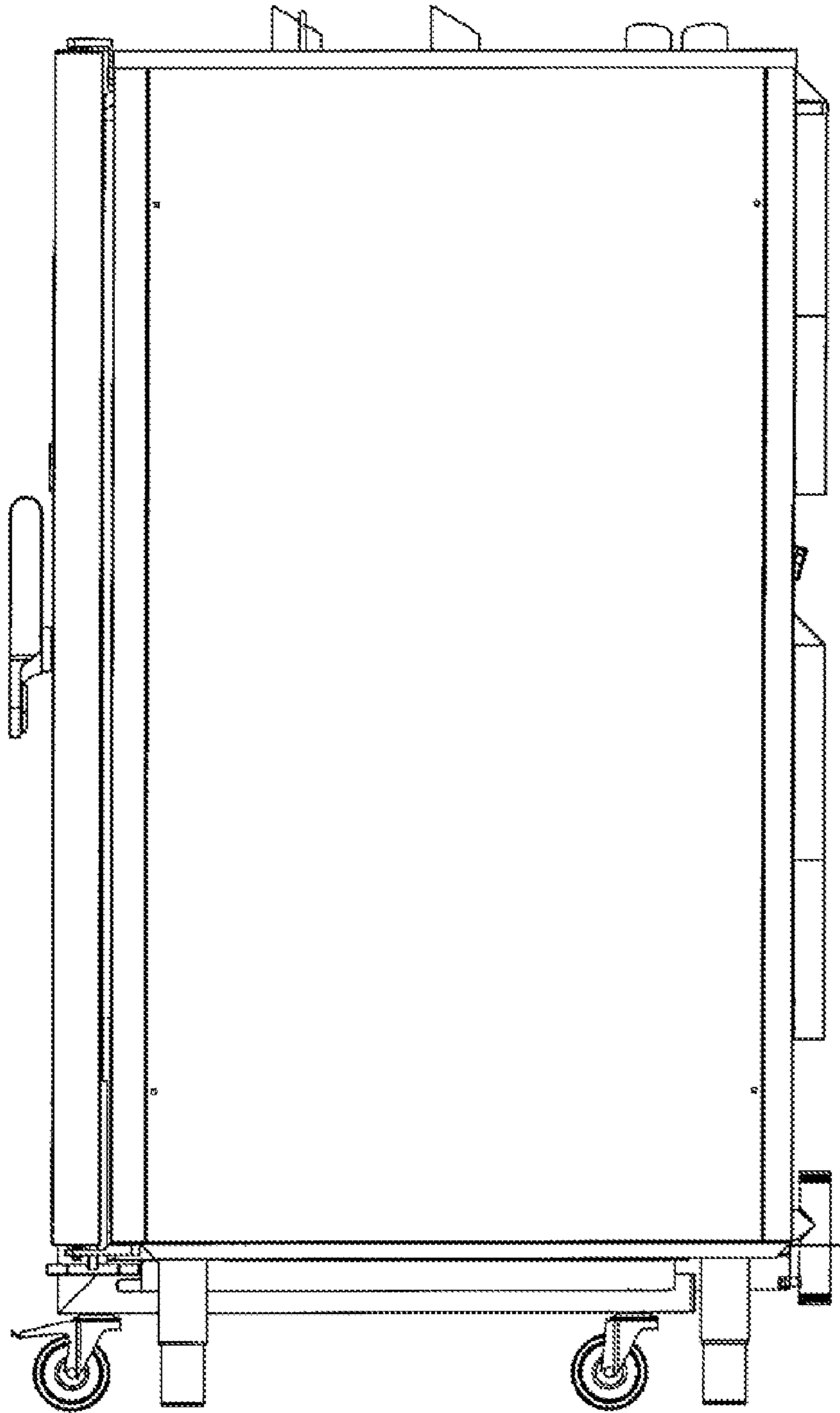

Fig. 12

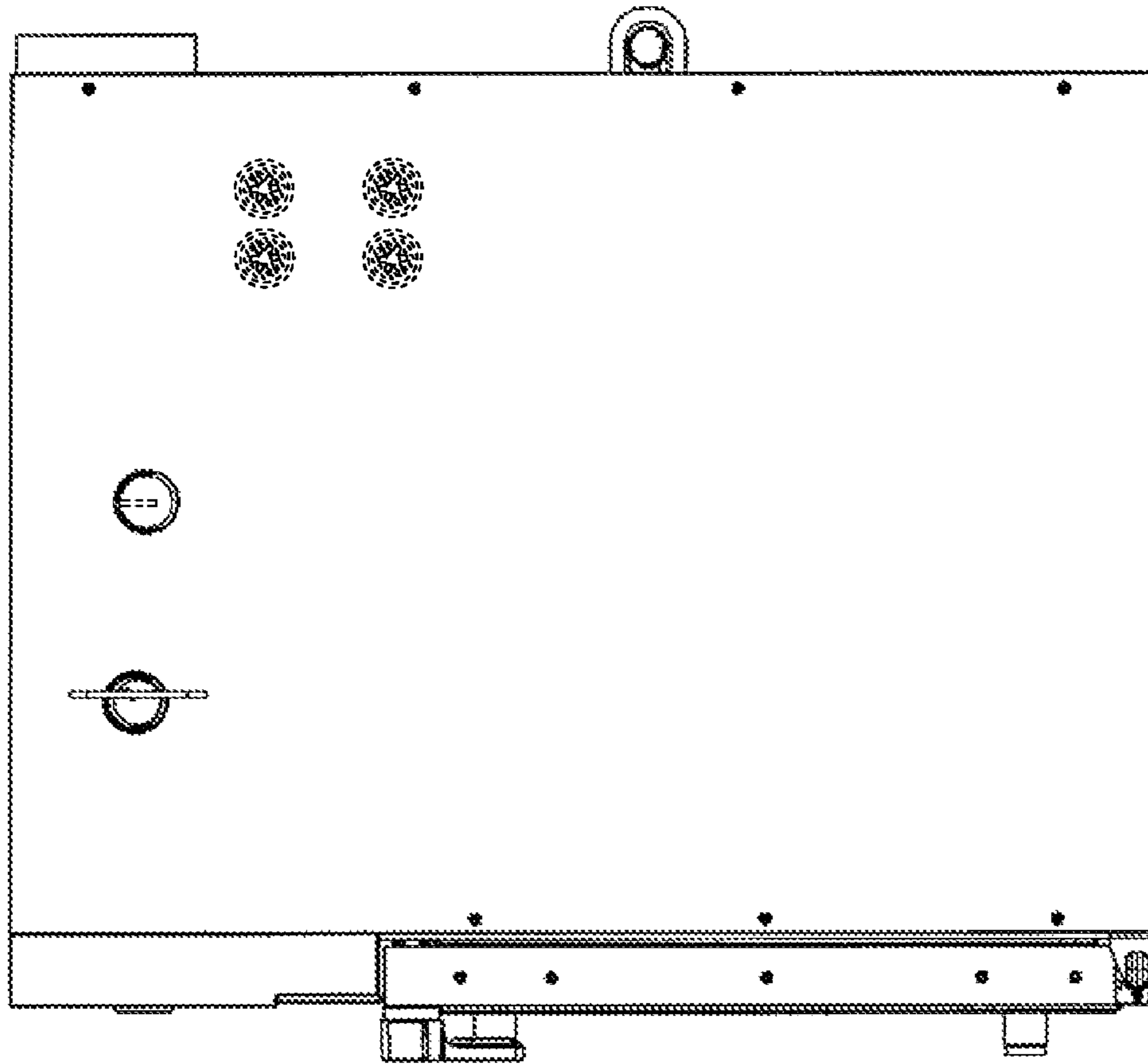

Fig. 13

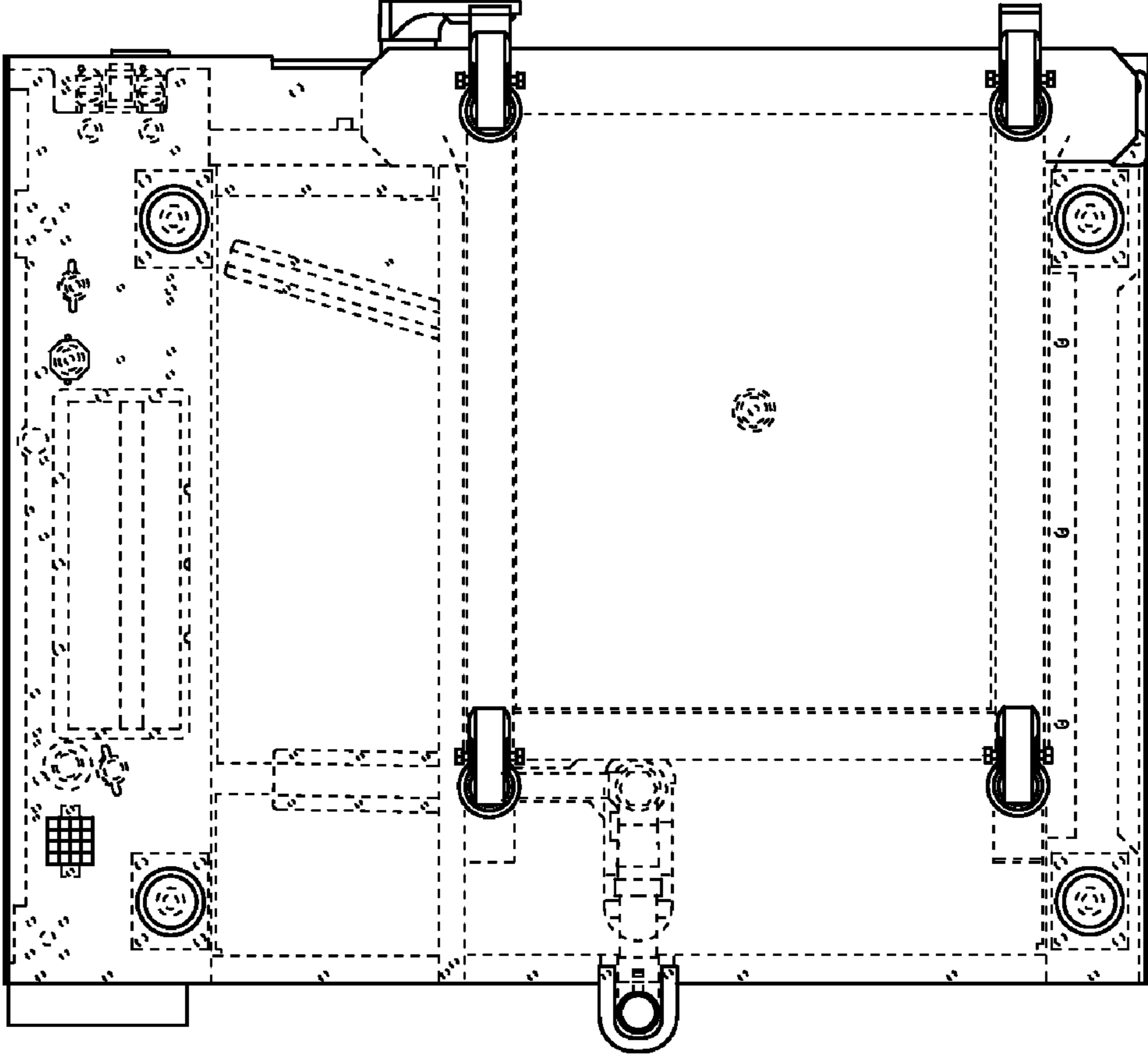

Fig. 14