



US00D657176S

(12) **United States Design Patent**
Stern

(10) **Patent No.:** **US D657,176 S**

(45) **Date of Patent:** **** Apr. 10, 2012**

(54) **SUPPORT RING**

(75) **Inventor:** **Marilyn Myres Stern**, Washington, DC
(US)

(73) **Assignee:** **Marilyn Stern**, Washington, DC (US)

(**) **Term:** **14 Years**

(21) **Appl. No.:** **29/372,844**

(22) **Filed:** **Jan. 24, 2011**

(51) **LOC (9) Cl.** **06-10**

(52) **U.S. Cl.** **D6/580**

(58) **Field of Classification Search** D6/575,
D6/576, 578, 579, 580, 581; 160/38, 39,
160/168.1, 168.1 R, 168.1 V, 173, 173 R,
160/176.1 R, 176.1 V, 178.1 R, 178.2, 331,
160/349.1; D15/28; D7/409; D12/604;
D13/107; D16/219; D23/213

See application file for complete search history.

(56) **References Cited**

U.S. PATENT DOCUMENTS

D310,708 S * 9/1990 Hengesbach D23/213
D313,458 S * 1/1991 Hengesbach D23/213

D322,305 S * 12/1991 Hengesbach D23/213
D465,505 S * 11/2002 Nasu D16/219
D477,273 S * 7/2003 Christenbury et al. D12/604
D503,378 S * 3/2005 Hussaini et al. D13/107
D542,091 S * 5/2007 Hoff et al. D7/409

* cited by examiner

Primary Examiner — Susan Bennett Hattan

Assistant Examiner — Barbara B Lohr

(57) **CLAIM**

The ornamental design for a support ring, as shown and described.

DESCRIPTION

FIG. 1 is a perspective view of a support ring showing my new design;
FIG. 2 is a front elevational view thereof;
FIG. 3 is a back elevational view thereof;
FIG. 4 is a right side elevational view thereof;
FIG. 5 is a left side elevational view thereof;
FIG. 6 is a top plan view thereof;
FIG. 7 is a bottom plan view thereof; and,
FIG. 8 is a plan view of the separate disassembled elements thereof.

1 Claim, 7 Drawing Sheets

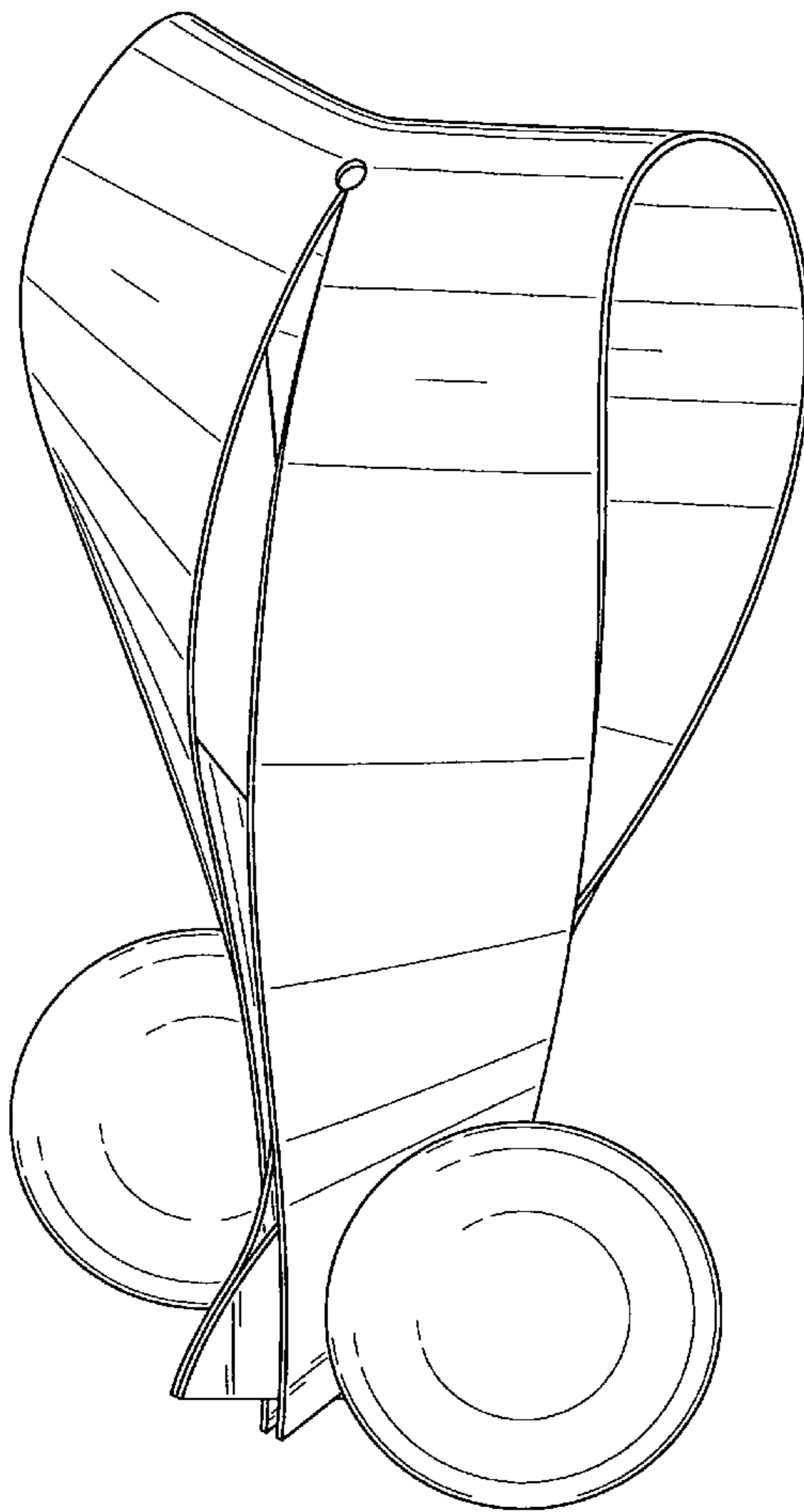

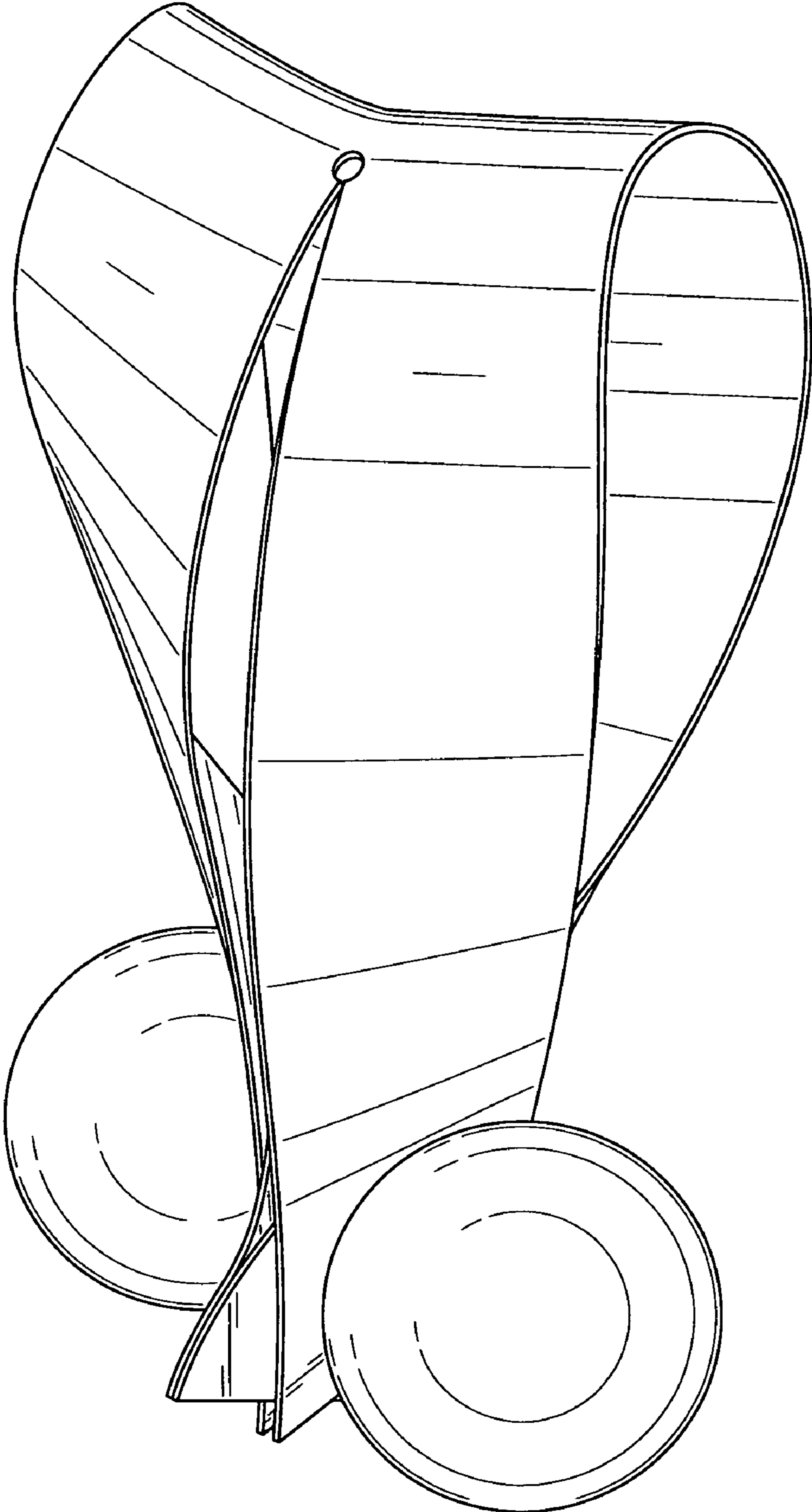

FIG. 1

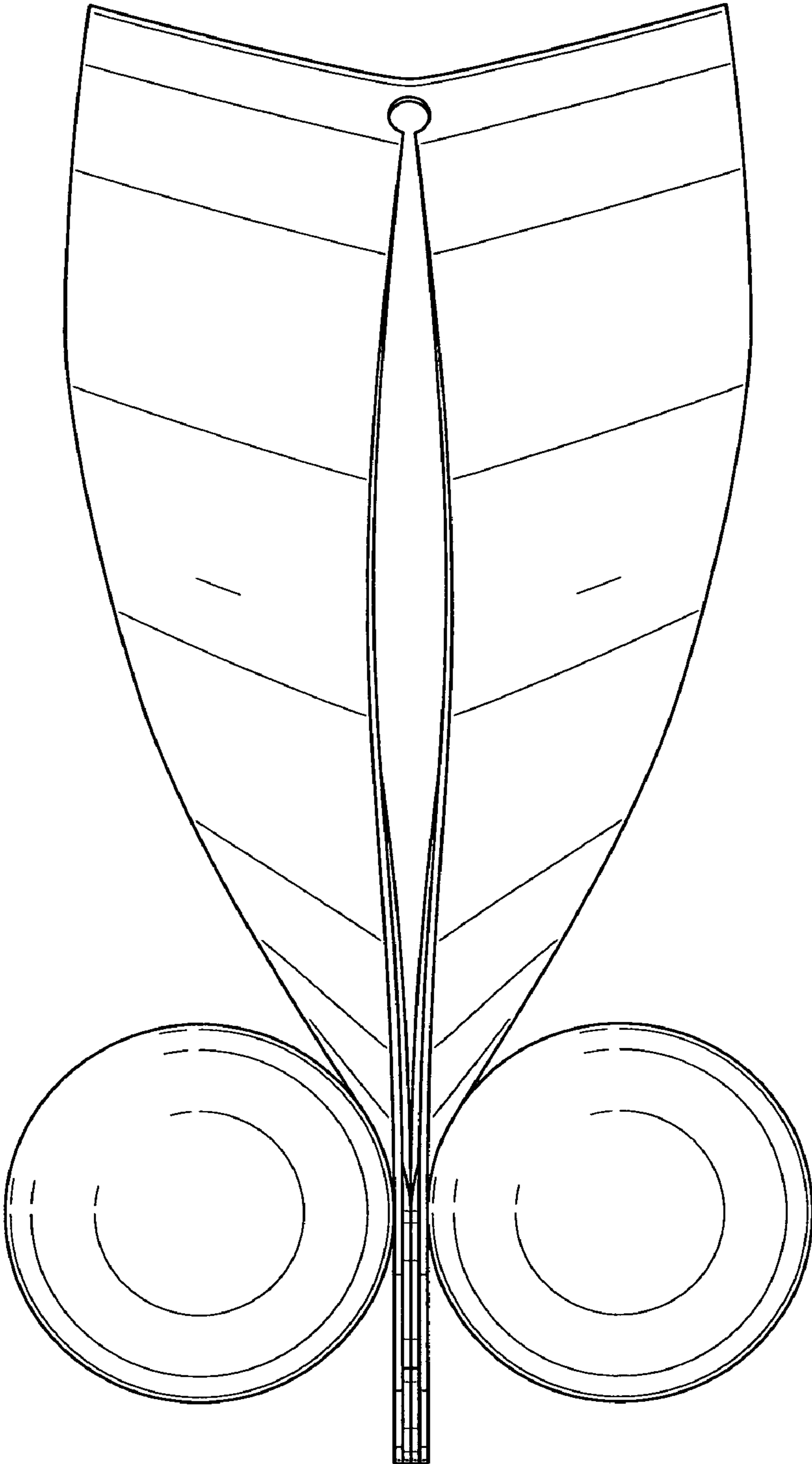

FIG. 2

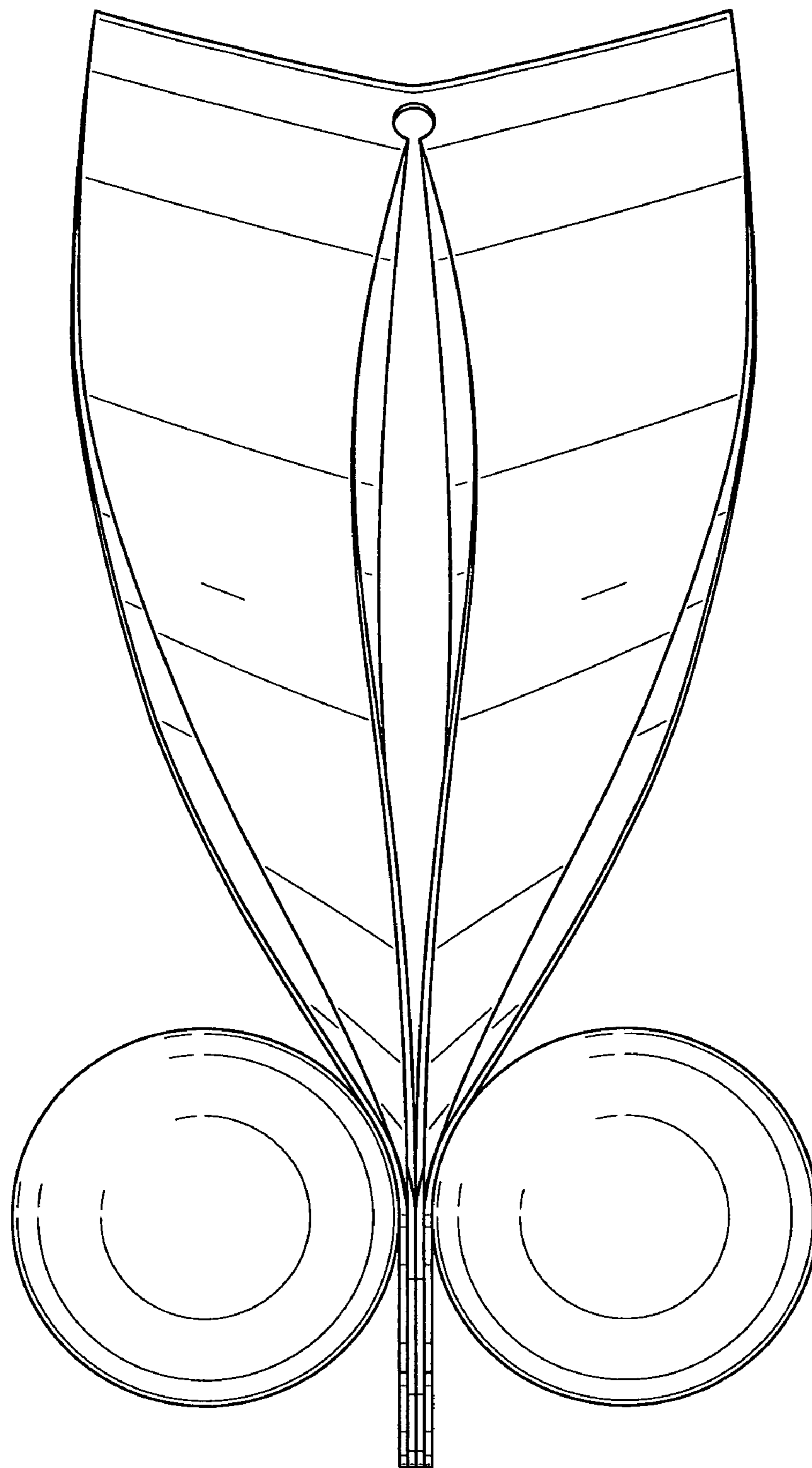

FIG. 3

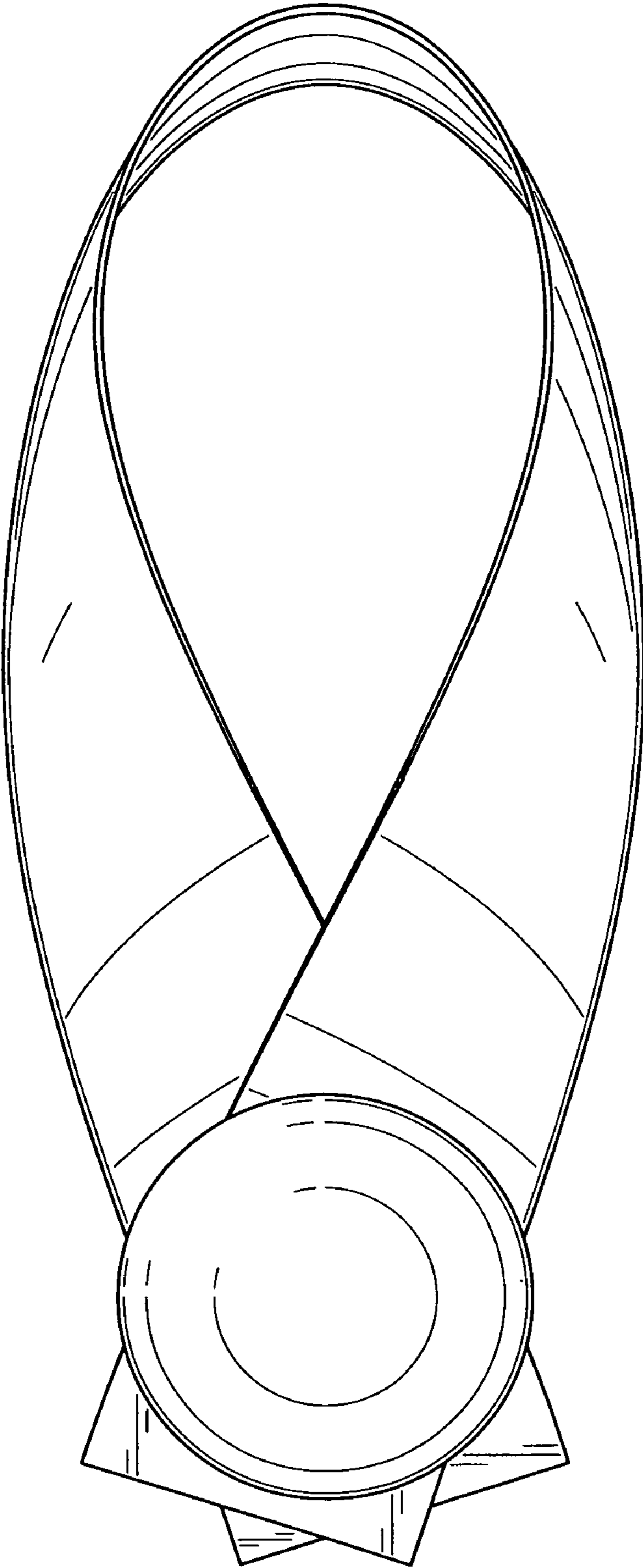

FIG. 4

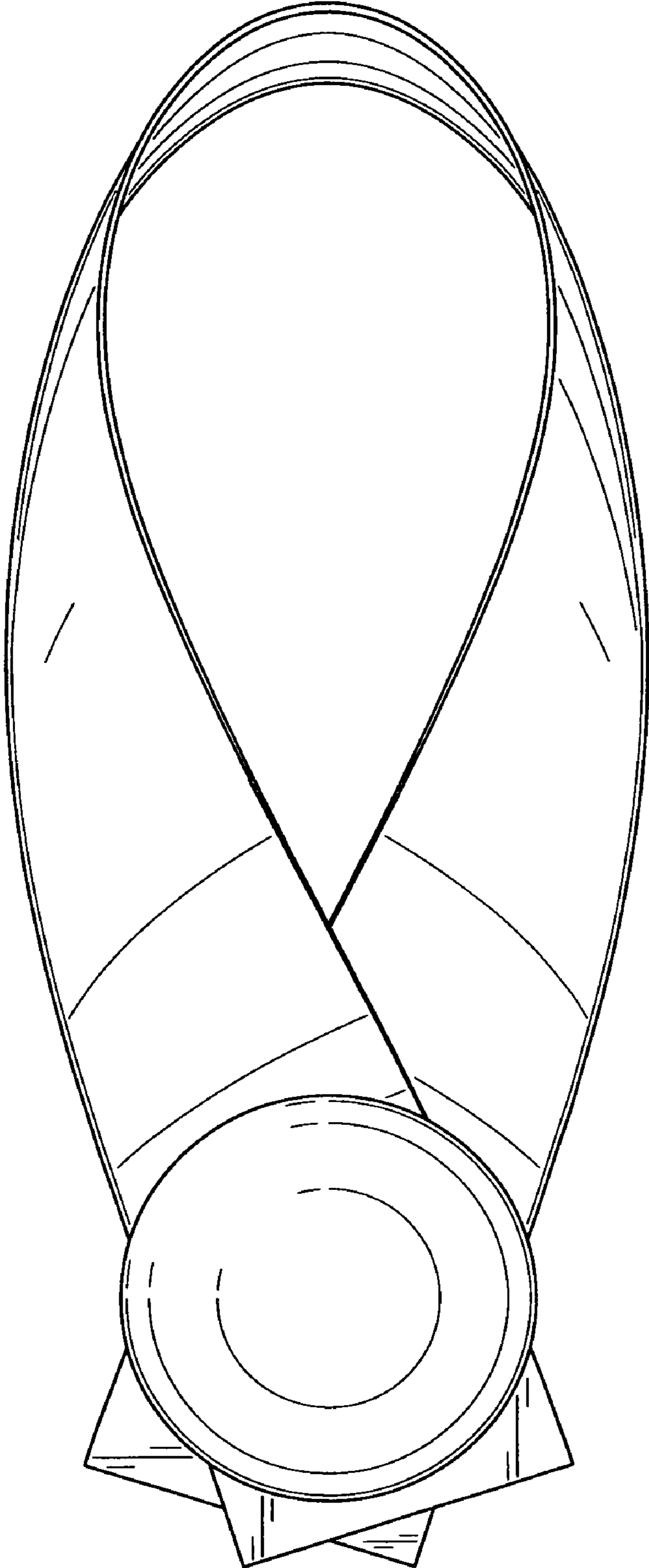

FIG. 5

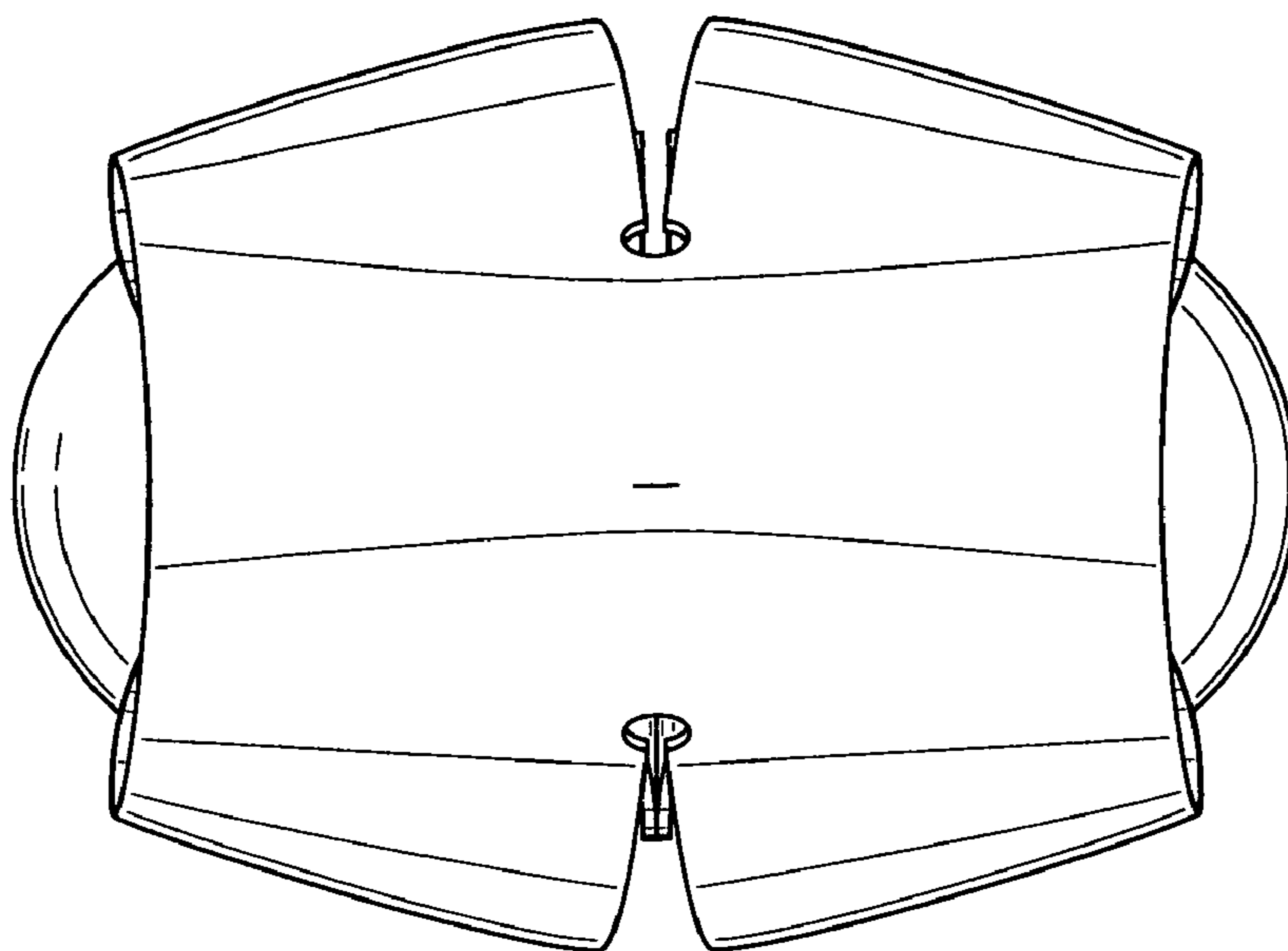

FIG. 6

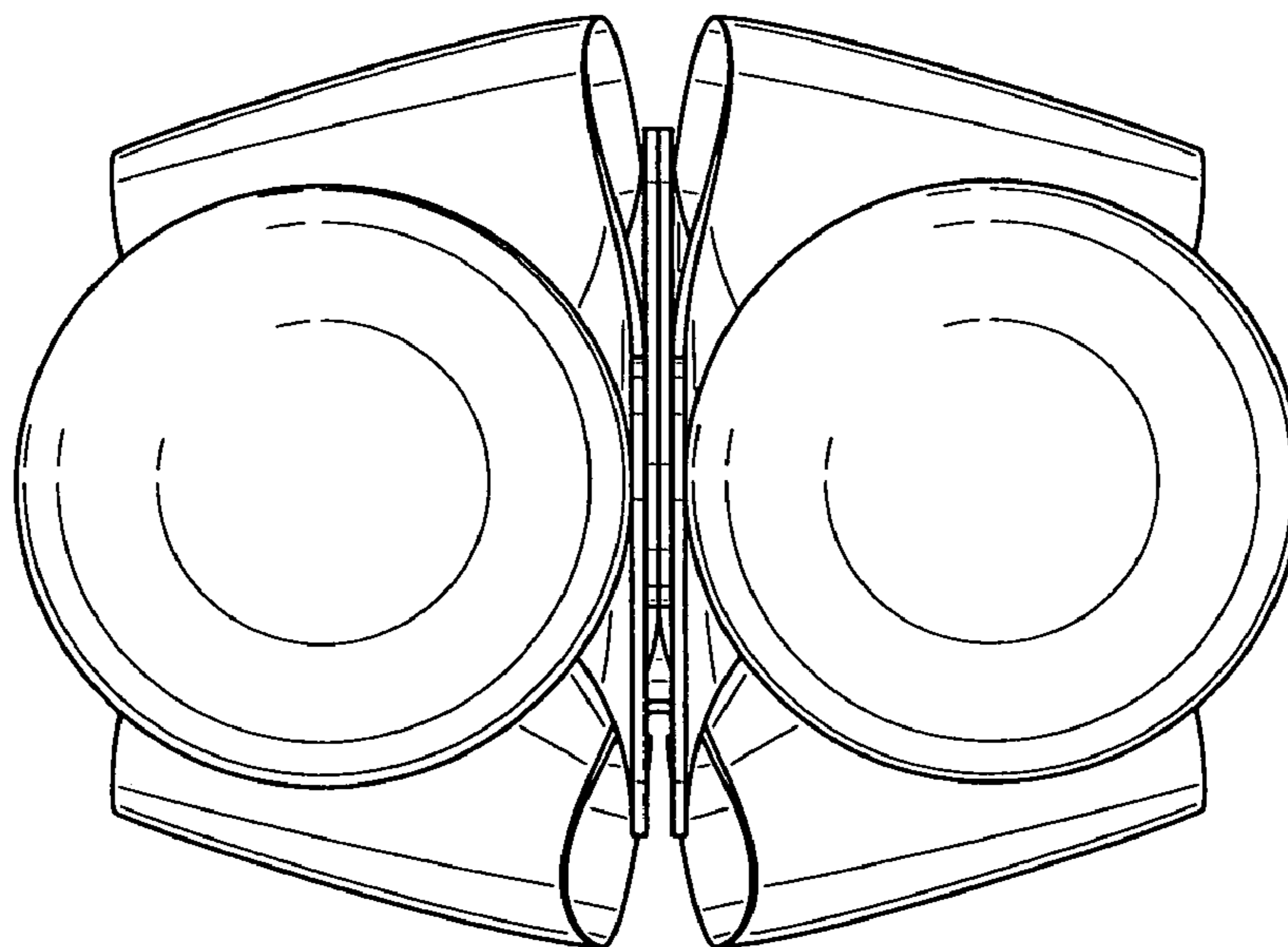

FIG. 7

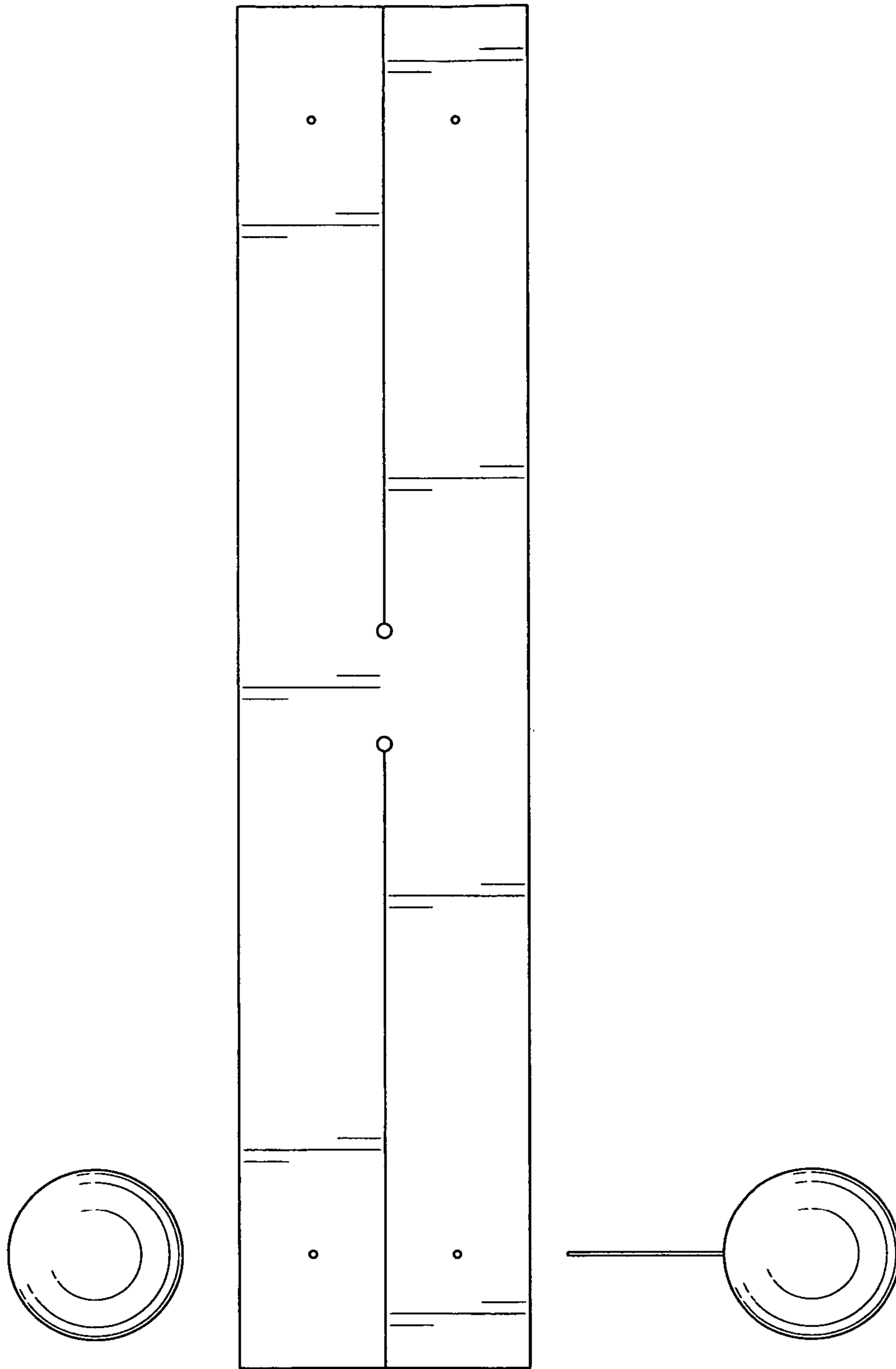

FIG. 8