



US00D657143S

(12) **United States Design Patent**
Jowett

(10) **Patent No.:** **US D657,143 S**
(45) **Date of Patent:** **** Apr. 10, 2012**

(54) **CONTAINER FOR STORAGE AND TRANSPORTATION OF GOODS**

(75) Inventor: **Leigh Jowett**, South Yorkshire (GB)

(73) Assignee: **Loadhog Limited** (GB)

(**) Term: **14 Years**

(21) Appl. No.: **29/366,212**

(22) Filed: **Jul. 21, 2010**

(30) **Foreign Application Priority Data**

Jul. 12, 2010 (EM) 001730508

(51) **LOC (9) Cl.** **03-01**

(52) **U.S. Cl.** **D3/272; D3/294**

(58) **Field of Classification Search** D3/254,
D3/260, 273, 276, 280, 283-291, 302, 301,
D3/303, 905, 272, 294; 220/523, 524, 527,
220/4.27; 206/349, 372-379, 508, 511
See application file for complete search history.

(56) **References Cited**

U.S. PATENT DOCUMENTS

D248,015 S *	5/1978	Smith	D3/294
D257,528 S *	11/1980	Cherry	D3/294
D376,259 S *	12/1996	Dickinson et al.	D3/273
D389,309 S *	1/1998	Shaw	D3/294
D448,166 S *	9/2001	Zimmerman	D3/273

D480,560 S *	10/2003	Tanji	D3/294
D493,282 S *	7/2004	Dubois et al.	D3/273
6,845,878 B2 *	1/2005	Hayes et al.	220/839
D527,522 S *	9/2006	Kammerer	D3/291
D565,297 S *	4/2008	Stevens et al.	D3/272
D580,169 S *	11/2008	Gibson	D3/272
D580,170 S *	11/2008	Klotzman et al.	D3/272
D606,306 S *	12/2009	Monte	D3/273

* cited by examiner

Primary Examiner — Jennifer Rivard

(74) *Attorney, Agent, or Firm* — Clark Hill PLC

(57) **CLAIM**

The ornamental design for a container for storage and transportation of goods, as shown and described.

DESCRIPTION

FIG. 1 is a front elevation view of the container for storage and transportation of goods;
FIG. 2 is a back elevation view of the container for storage and transportation of goods;
FIG. 3 is a left elevation view of the container for storage and transportation of goods;
FIG. 4 is a right elevation view of the container for storage and transportation of goods;
FIG. 5 is a top plan view of the container for storage and transportation of goods;
FIG. 6 is a bottom plan view of the container for storage and transportation of goods; and,
FIG. 7 is an isometric view of the container for storage and transportation of goods.

1 Claim, 4 Drawing Sheets

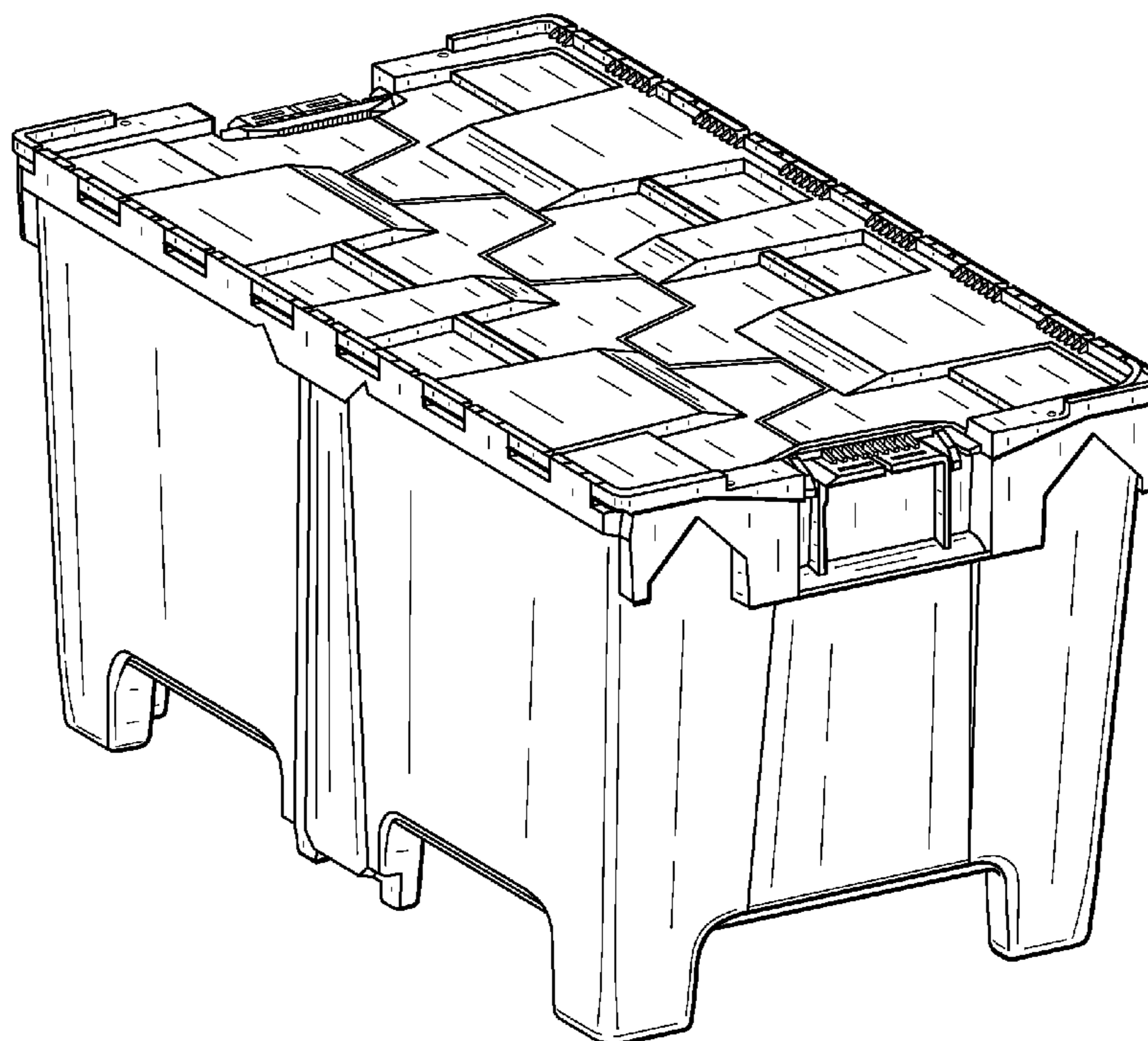

FIG. 1

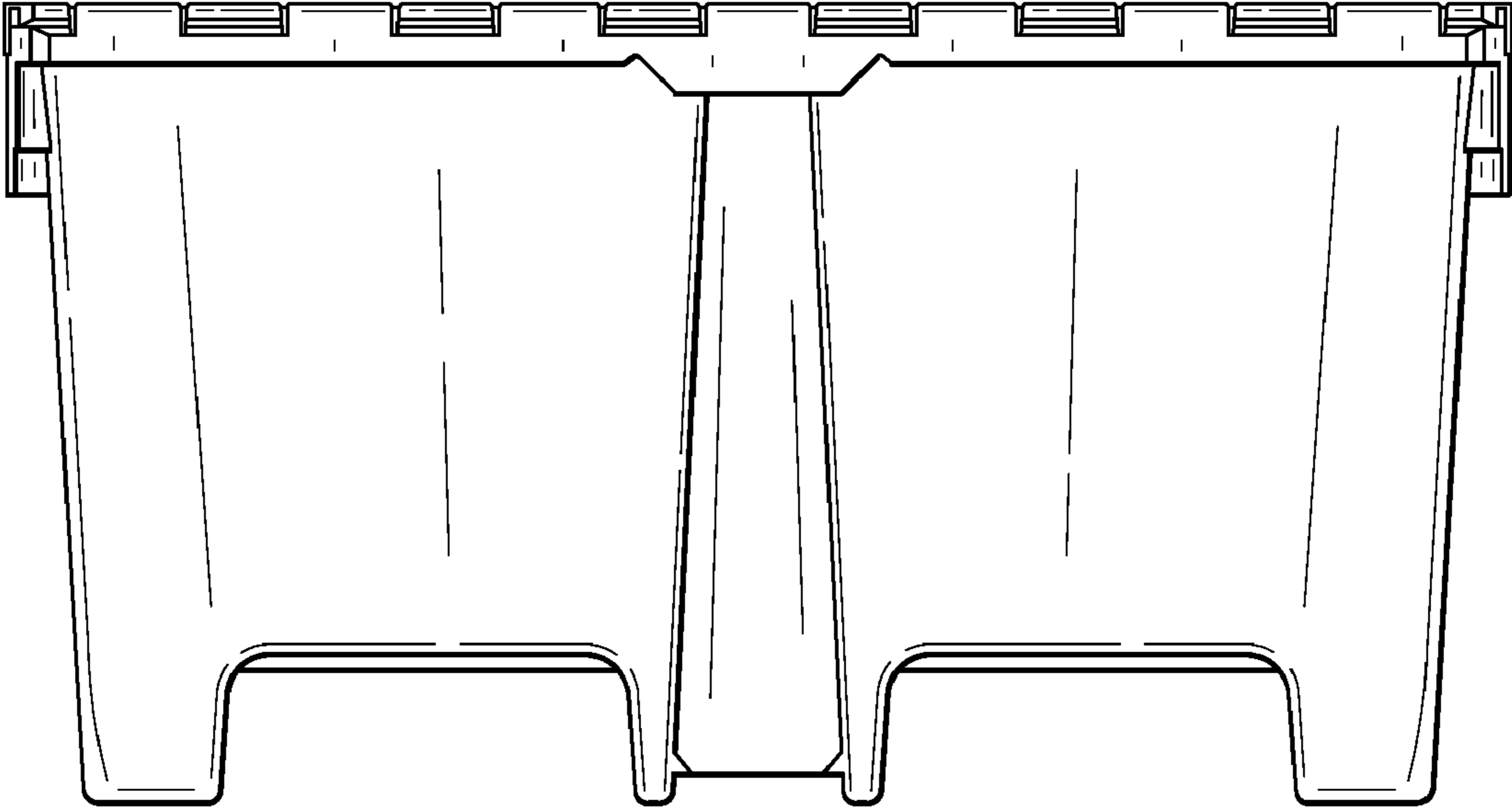

FIG. 2

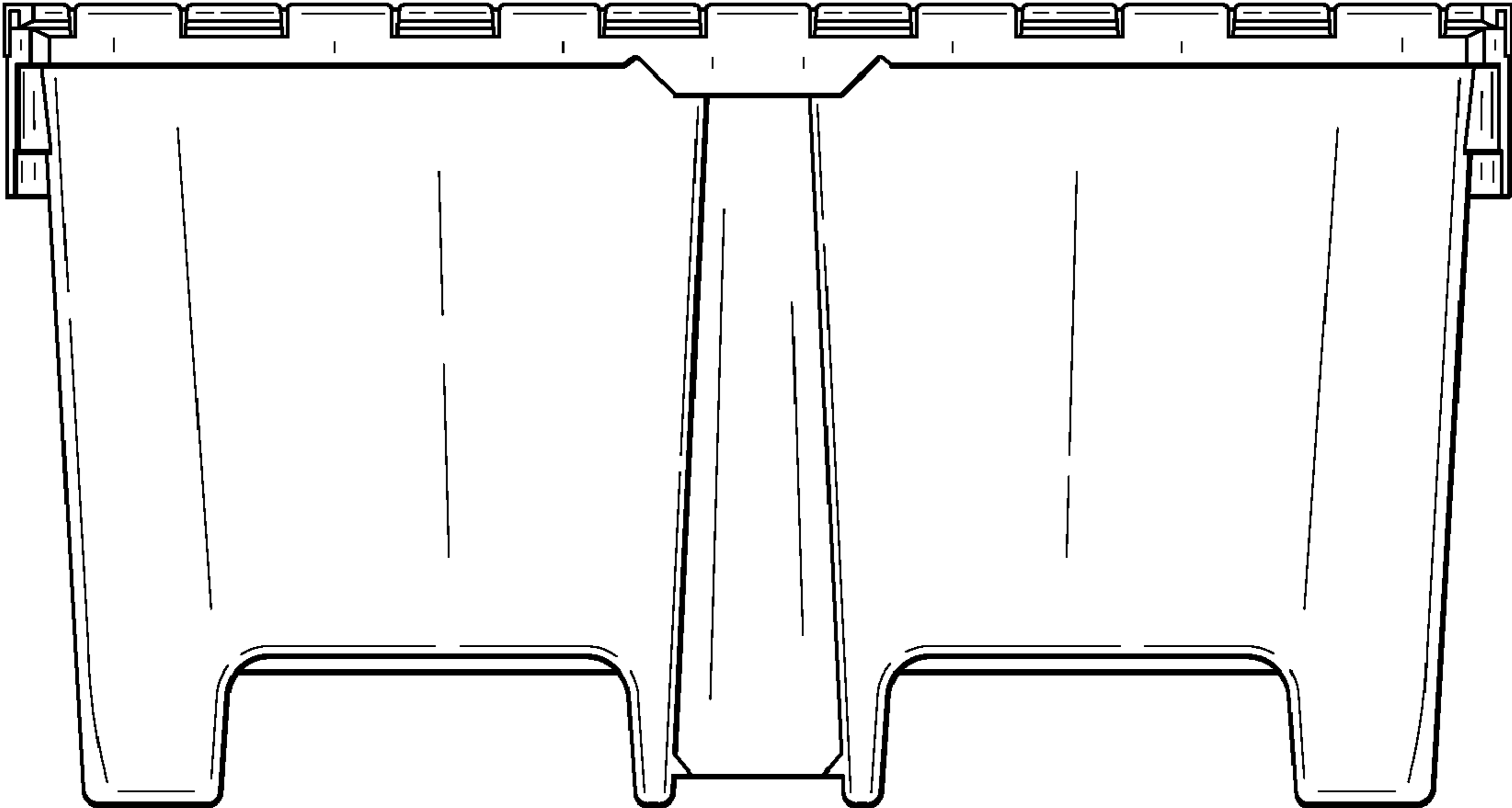

FIG. 3

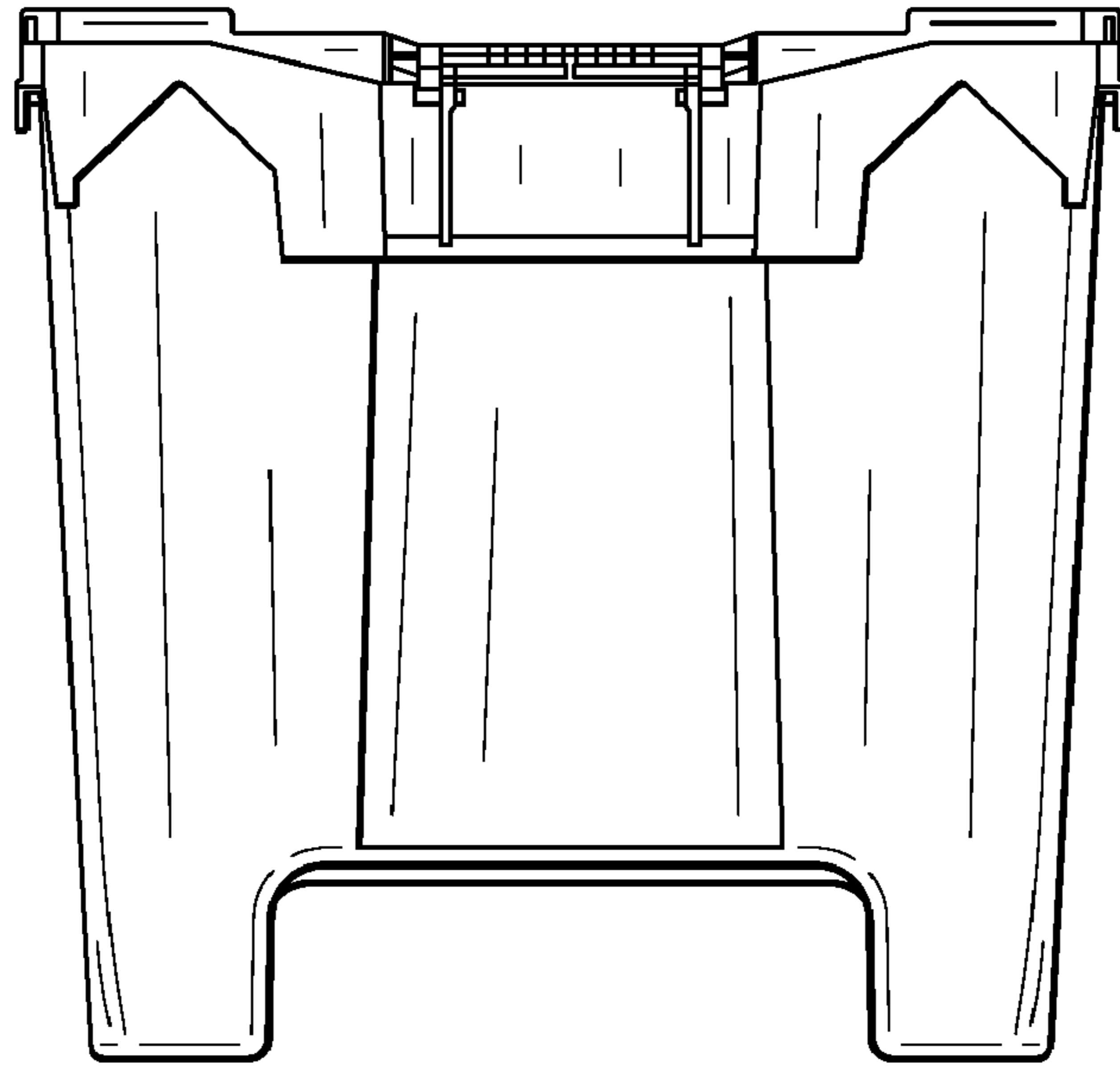

FIG. 4

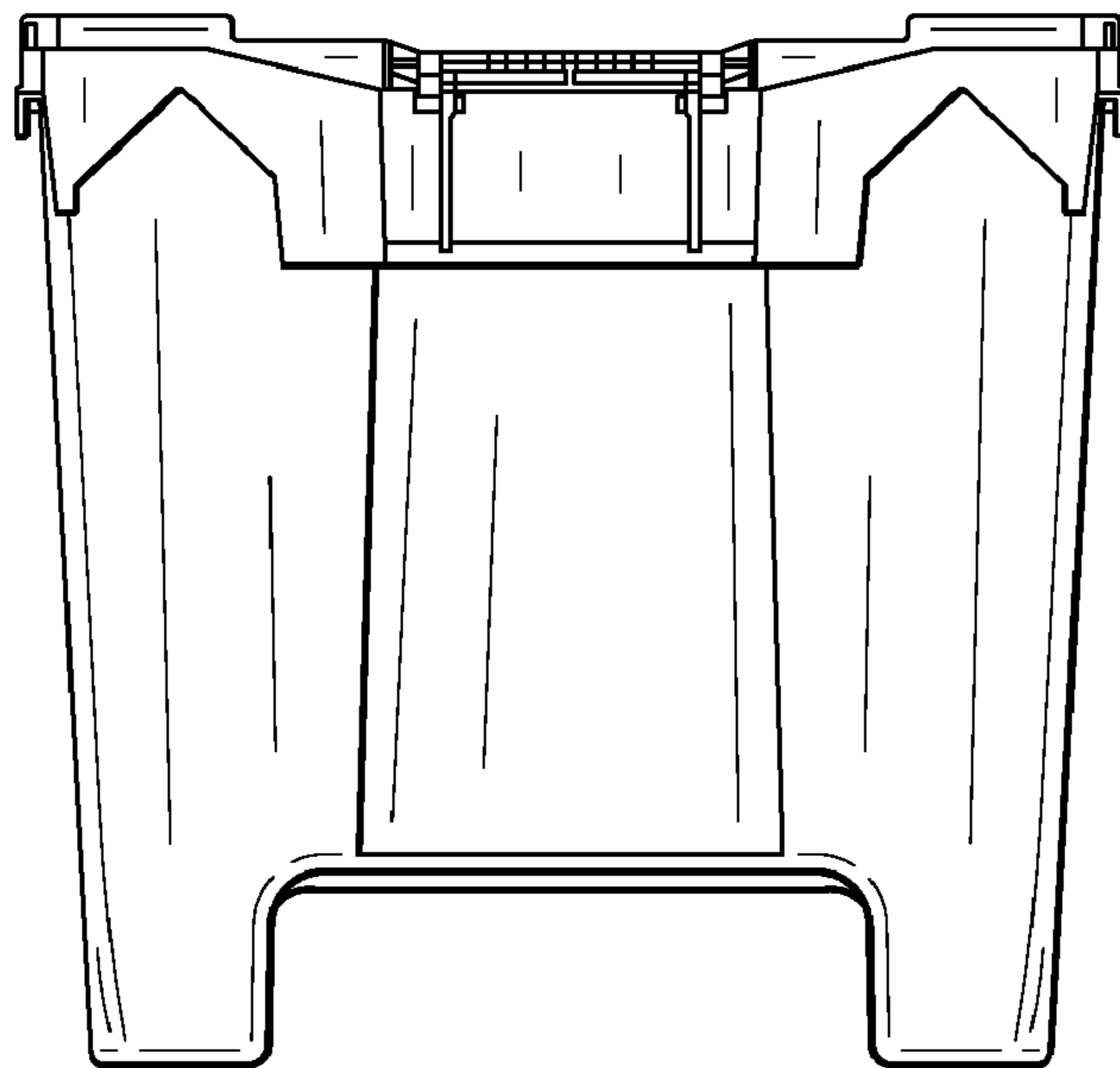

FIG. 5

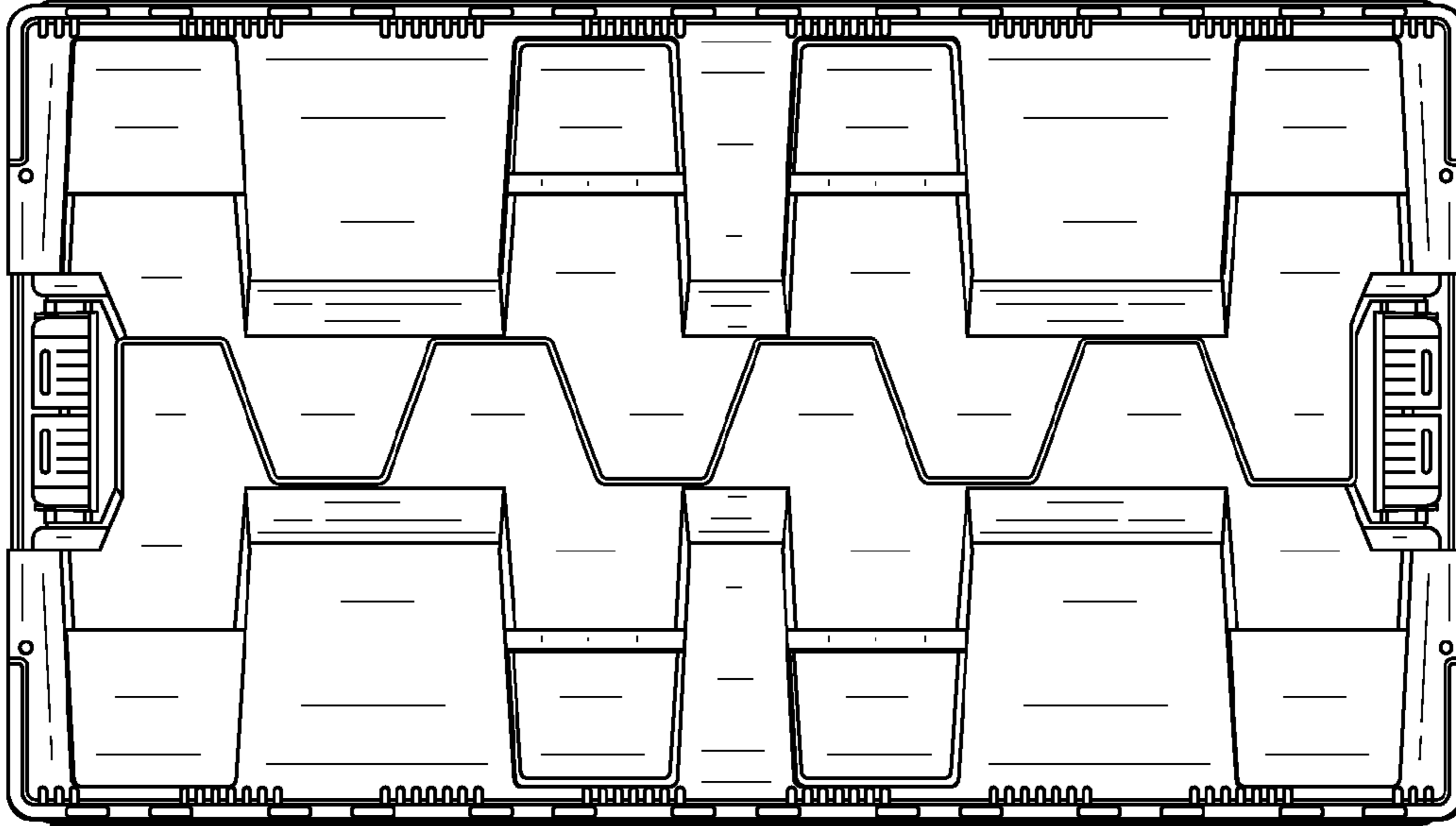

FIG. 6

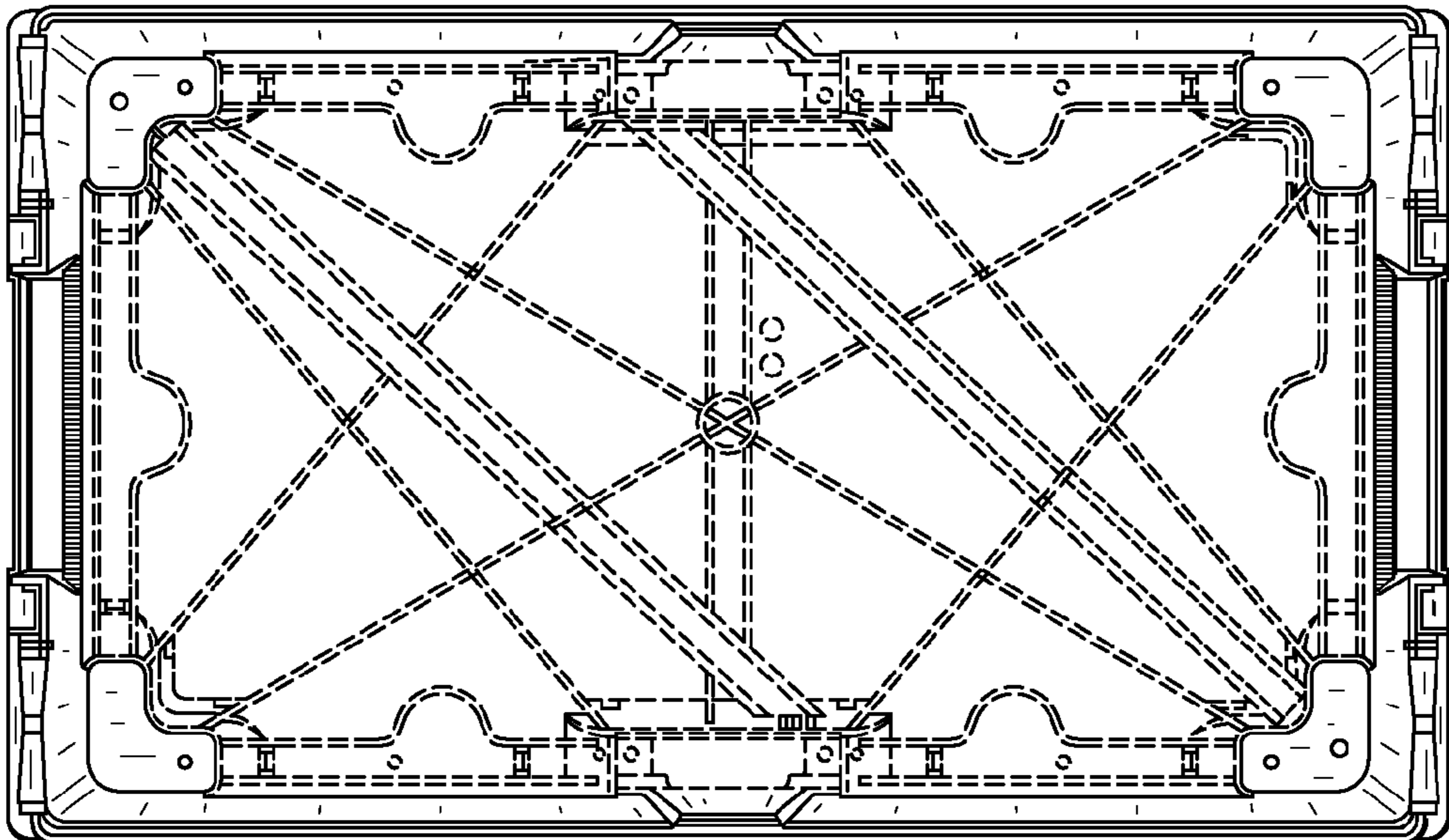

FIG. 7

