



US00D657135S

(12) **United States Design Patent**
Fahrendorff et al.

(10) **Patent No.:** **US D657,135 S**

(45) **Date of Patent:** **** *Apr. 10, 2012**

(54) **HOLSTER**

(75) Inventors: **Anders Fahrendorff**, Ottawa (CA);
Andrew David Lowe, Unionville (CA);
Todd Andrew Wood, Guelph (CA)

(73) Assignee: **Research In Motion Limited**, Waterloo,
Ontario (CA)

(*) Notice: This patent is subject to a terminal dis-
claimer.

(**) Term: **14 Years**

(21) Appl. No.: **29/377,250**

(22) Filed: **Oct. 19, 2010**

(51) **LOC (9) Cl.** **03-01**

(52) **U.S. Cl.** **D3/218**

(58) **Field of Classification Search** D3/201,
D3/215–219, 226, 269, 272–273, 265, 247–249;
206/305, 320; 455/90, 92, 42; 379/455;
224/250, 666, 674–677, 680–683, 240, 901;
D14/496, 156, 138, 250, 253

See application file for complete search history.

(56) **References Cited**

U.S. PATENT DOCUMENTS

D382,996 S *	9/1997	Kopel	D3/218
D453,417 S *	2/2002	Badillo et al.	D3/218
D534,720 S *	1/2007	Infanti et al.	D3/218
D606,299 S *	12/2009	Boomhour et al.	D3/201
D606,301 S *	12/2009	Hofer et al.	D3/218

* cited by examiner

Primary Examiner — Catheri Oliver

(57) **CLAIM**

We claim the ornamental design for a holster, as shown and described.

DESCRIPTION

FIG. 1 is a front perspective view of a holster;
FIG. 2 is a rear perspective view of the holster;
FIG. 3 is a front elevational view thereof;
FIG. 4 is a rear elevational view thereof;
FIG. 5 is a right elevational view thereof;
FIG. 6 is a left elevational view thereof;
FIG. 7 is a top plan view thereof; and,
FIG. 8 is a bottom plan view thereof.
The broken lines shown in the drawings of the holster are for the purpose of illustrating portions of the article and form no part of the claimed design.

1 Claim, 6 Drawing Sheets

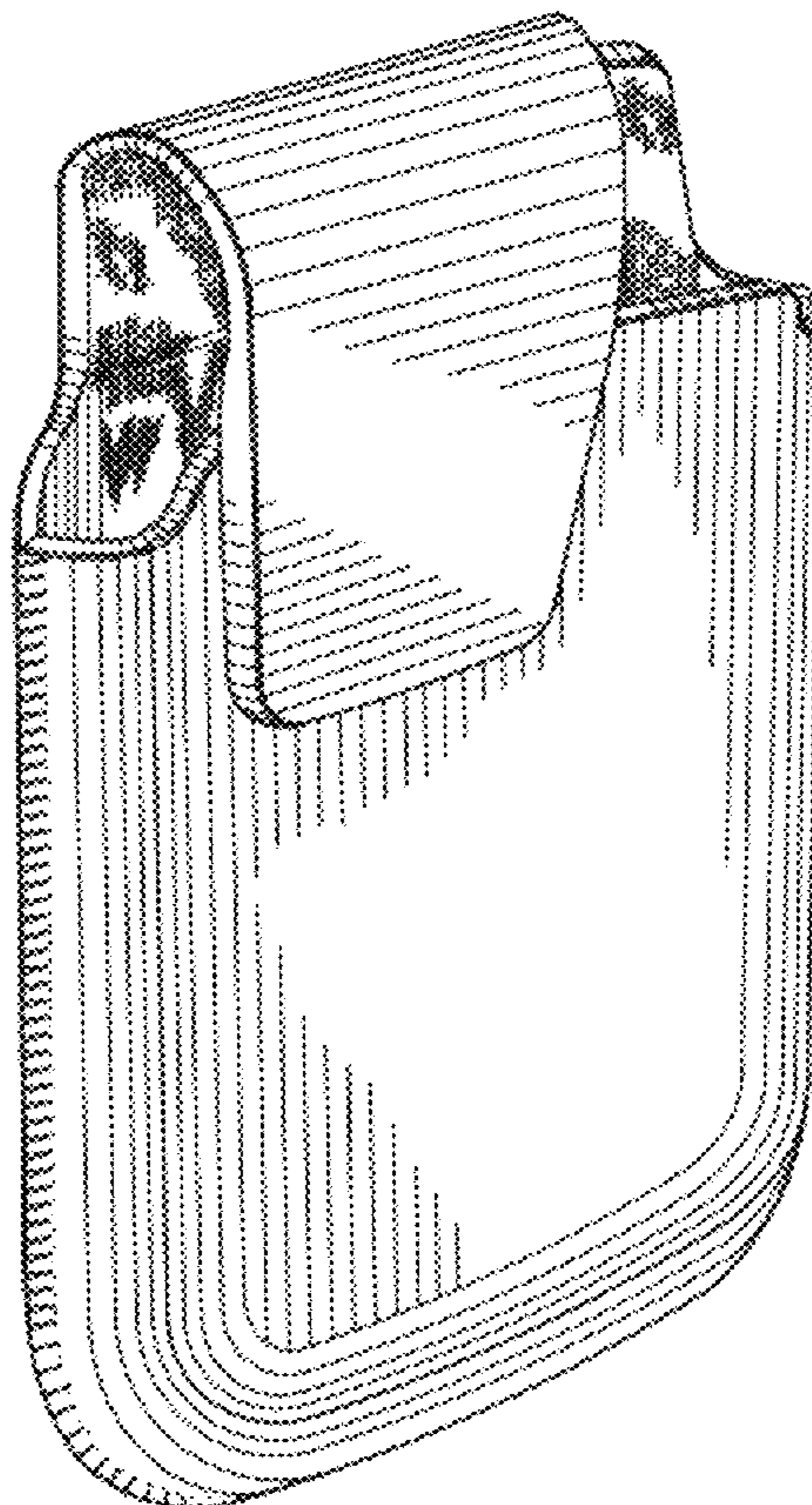

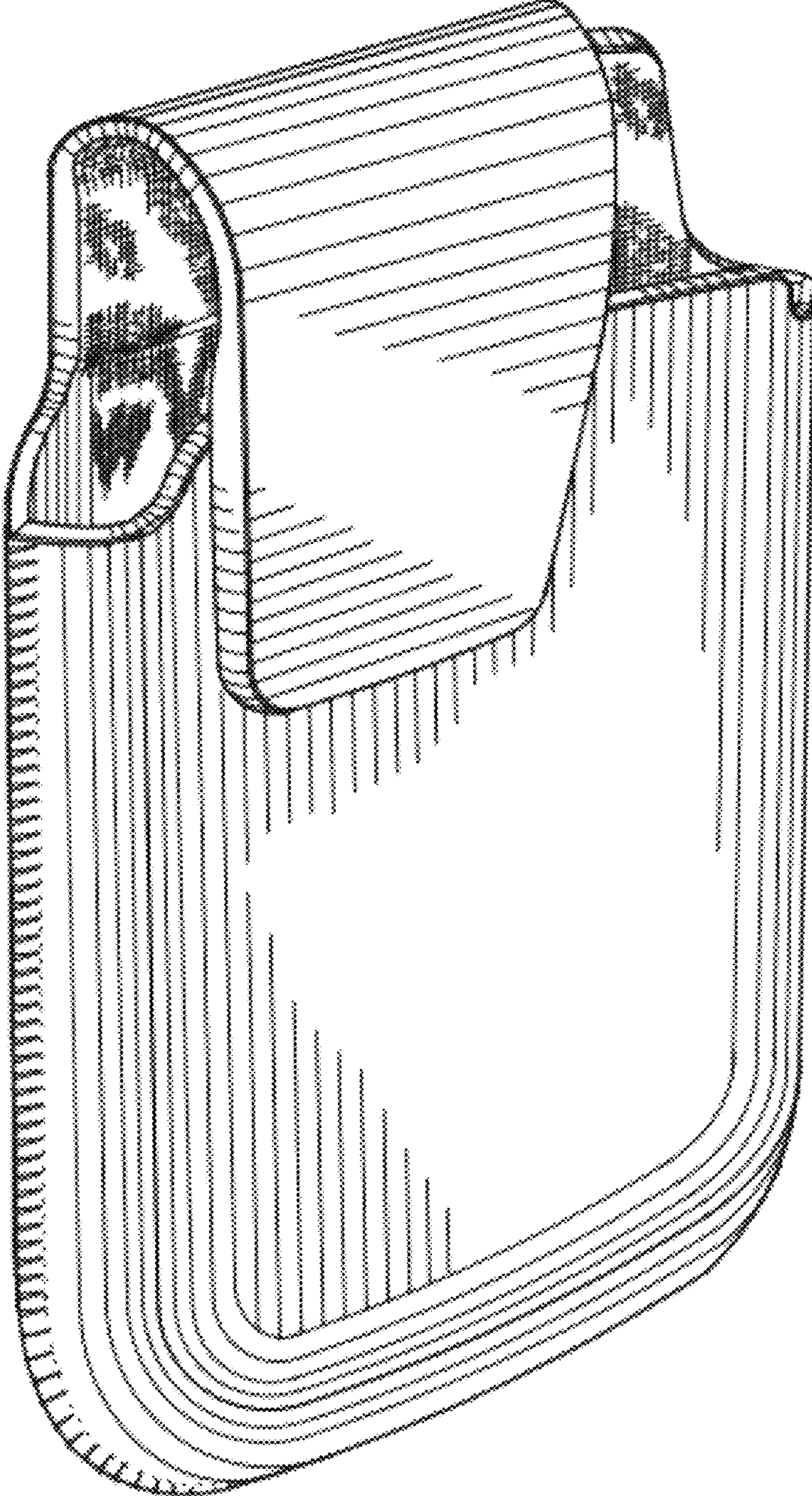

FIG. 1

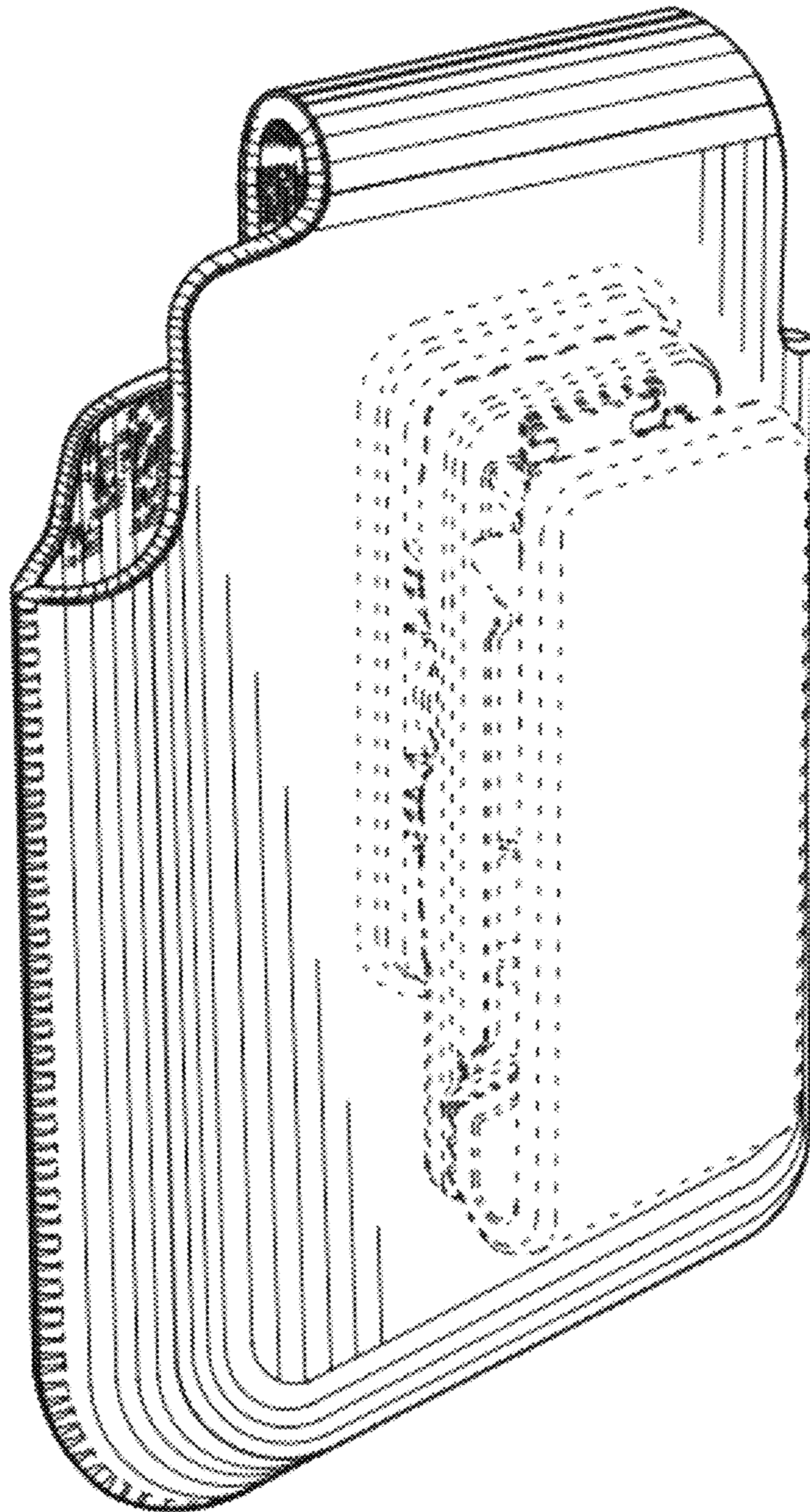

FIG.2

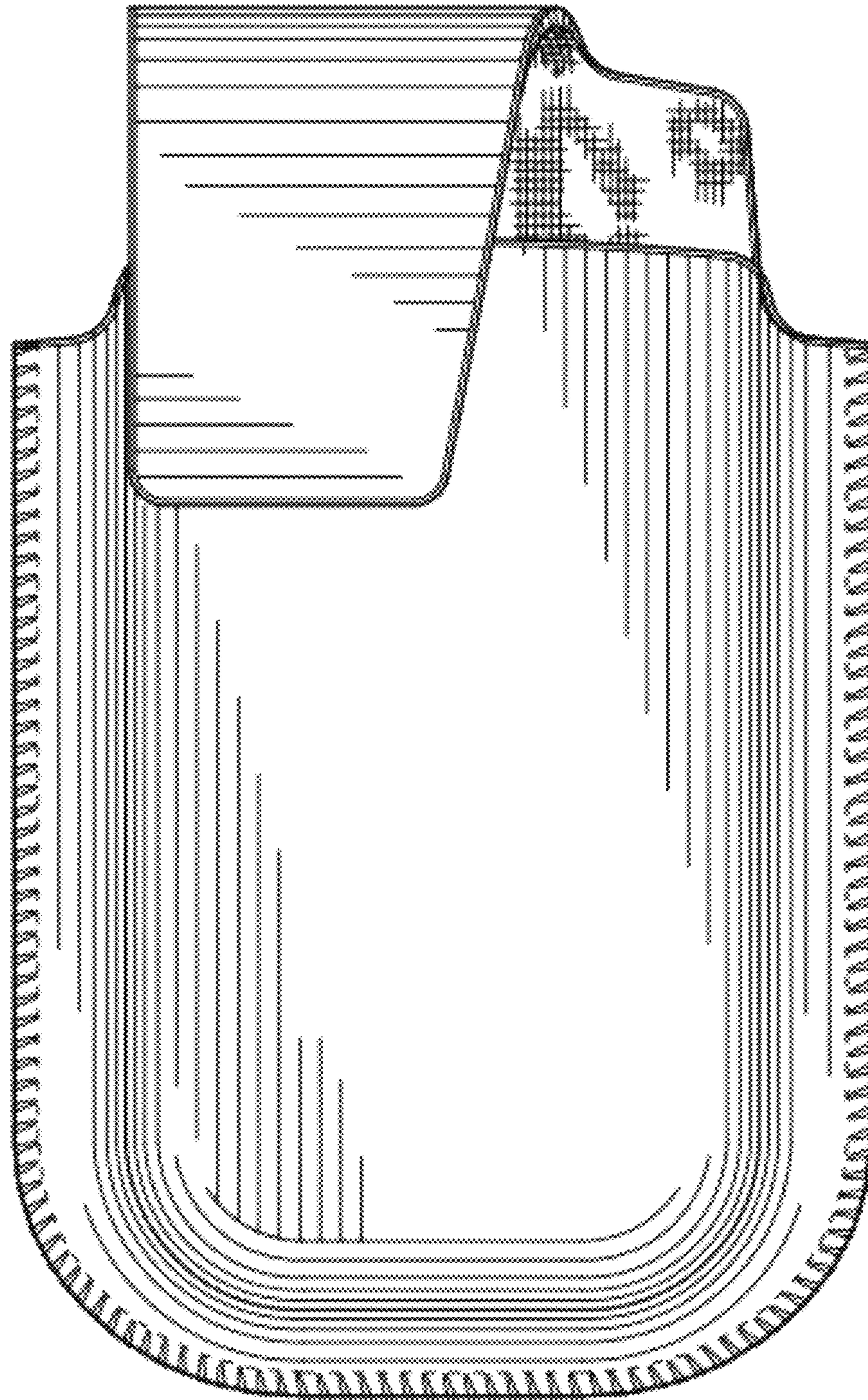

FIG.3

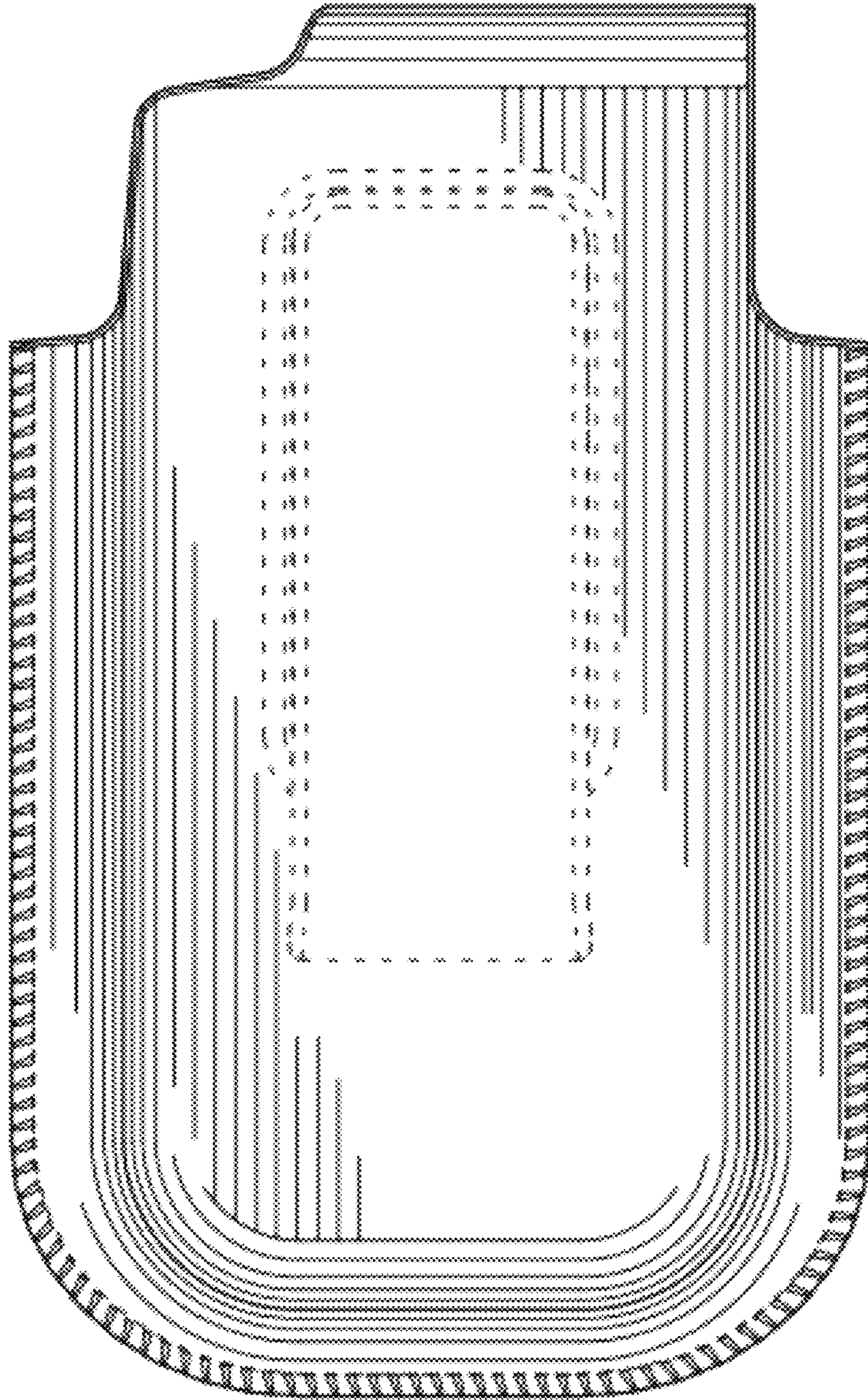

FIG.4

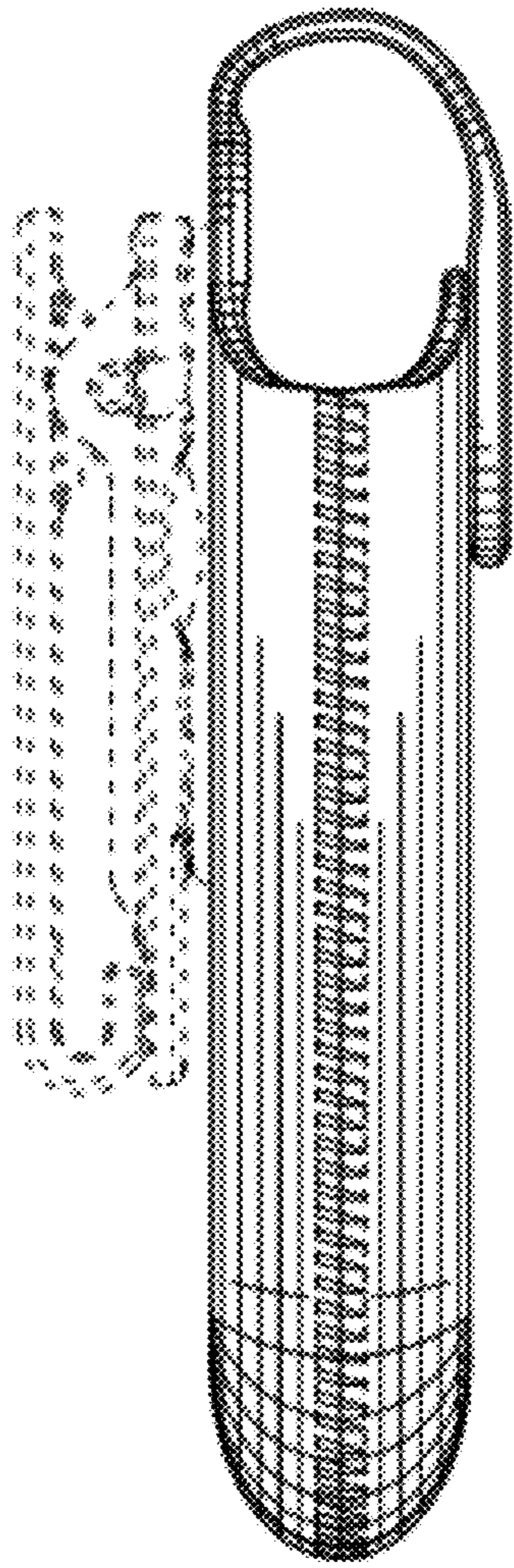

FIG. 5

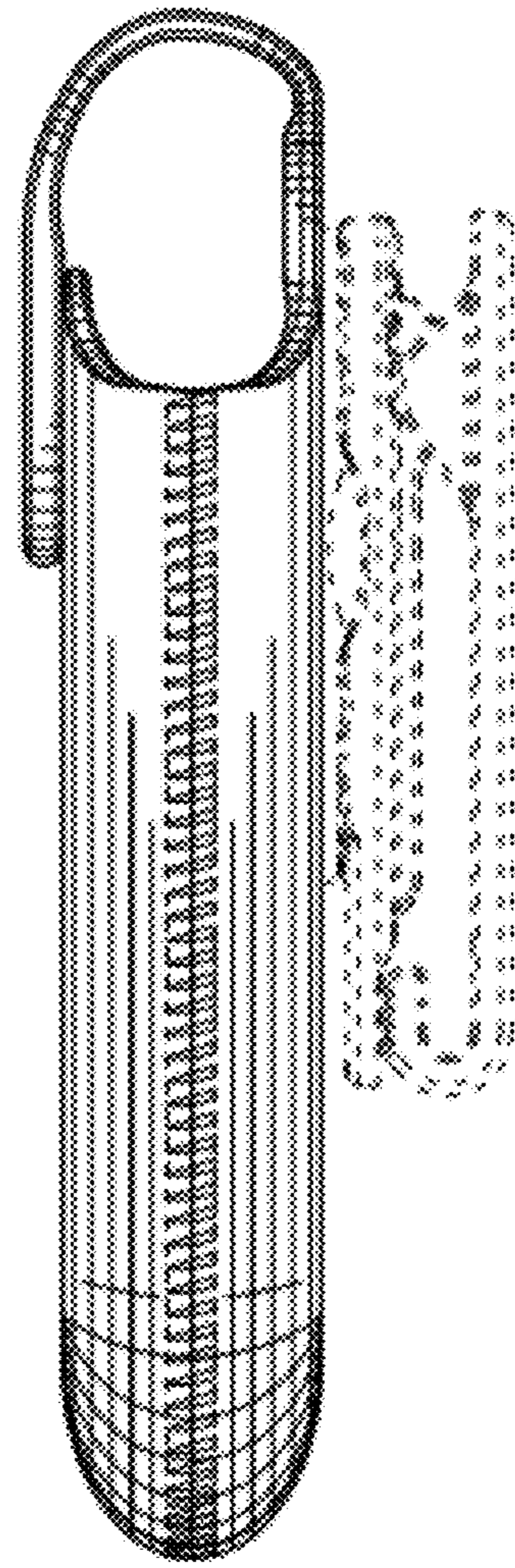

FIG. 6

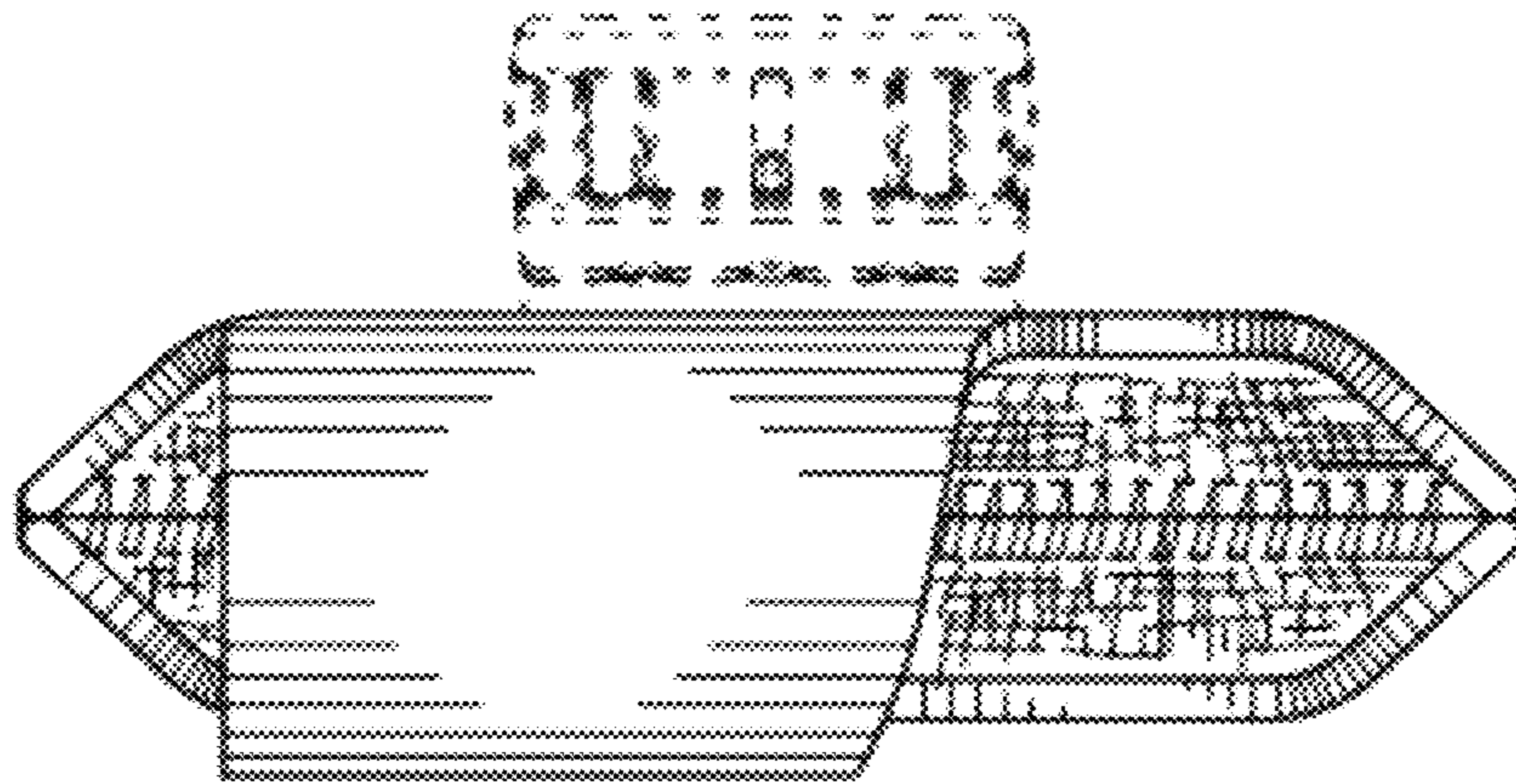

FIG. 7

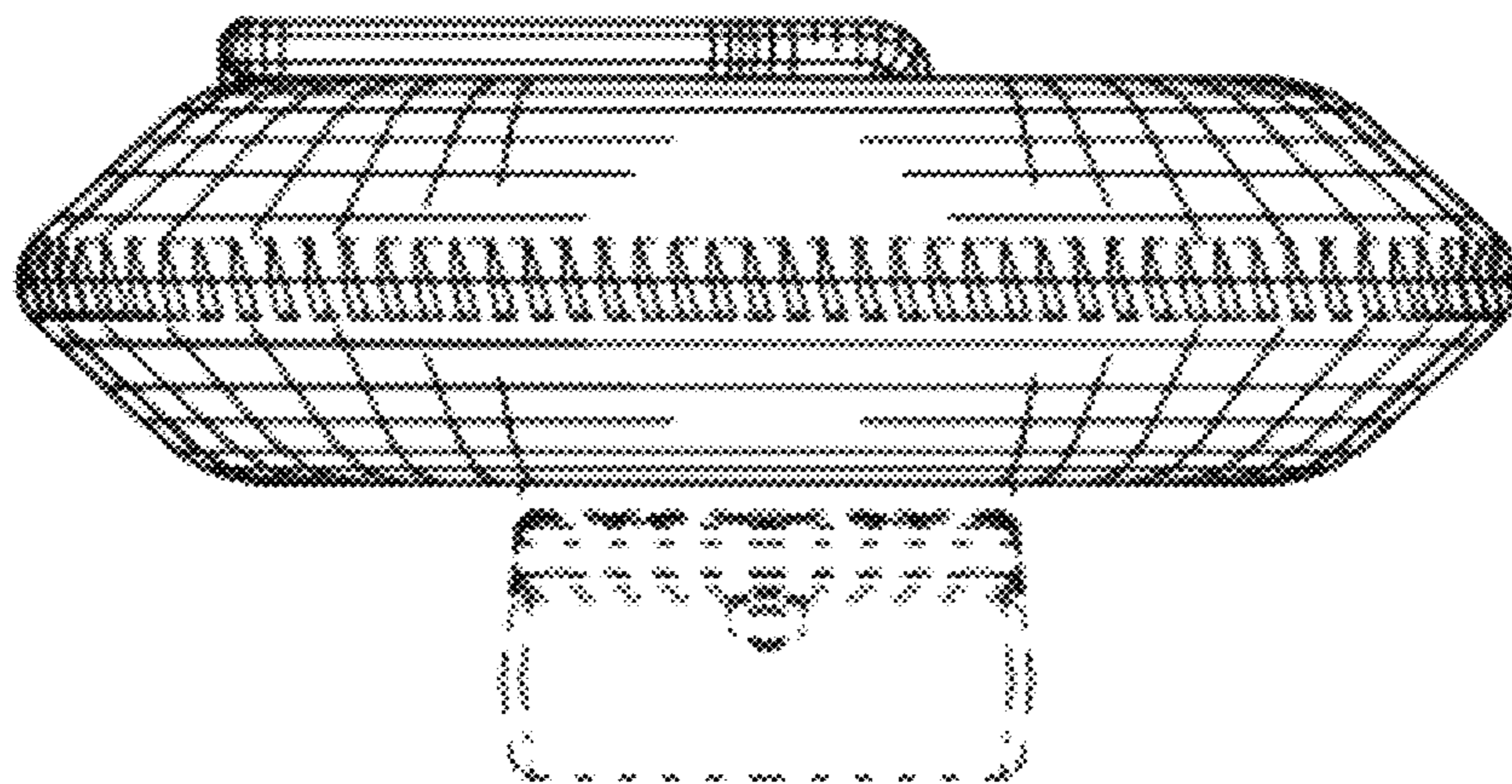

FIG. 8