

US00D657117S

(12) **United States Design Patent**  
**Burwell**

(10) **Patent No.:** **US D657,117 S**

(45) **Date of Patent:** **\*\* Apr. 10, 2012**

(54) **STITCHED BASEBALL-STYLE CAP**

(76) Inventor: **Joshua Burwell**, Portland, OR (US)

(\*\*) Term: **14 Years**

(21) Appl. No.: **29/379,535**

(22) Filed: **Nov. 19, 2010**

(51) **LOC (9) Cl.** ..... **02-03**

(52) **U.S. Cl.** ..... **D2/882**

(58) **Field of Classification Search** ..... D2/865,  
D2/866, 869, 870, 872, 875, 876, 877, 878,  
D2/879, 880, 881, 882, 884, 886, 889, 891,  
D2/892, 893, 894, 895; 2/171, 175.1, 195.1,  
2/195.2, 195.3, 195.4, 195.5, 195.6, 195.7,  
2/200.3, 209.12, 209.13, 209.3, 209.7  
See application file for complete search history.

(56) **References Cited**

**U.S. PATENT DOCUMENTS**

338,584	A *	3/1886	Crafts	.....	2/209.7
945,268	A *	1/1910	Dodd	.....	2/175.1
D90,197	S *	6/1933	Lish	.....	D2/865
D155,444	S *	10/1949	Noped	.....	D2/876
2,869,137	A *	1/1959	Scherz	.....	2/195.4
D196,166	S *	9/1963	Ellis	.....	D2/876
D226,544	S *	3/1973	Veltri	.....	D2/876
D297,065	S *	8/1988	Ross	.....	D2/876
D301,383	S *	6/1989	Pesta	.....	D2/869
D350,221	S *	9/1994	Van Doren	.....	D2/866
D480,539	S *	10/2003	Yan	.....	D2/882
D517,285	S *	3/2006	Williams, Jr.	.....	D2/872

7,073,207	B2 *	7/2006	Kim	.....	2/195.1
D580,634	S *	11/2008	Robinson	.....	D2/869
D592,833	S *	5/2009	Bain	.....	D2/869
D614,380	S *	4/2010	Lam et al.	.....	D2/882
D617,536	S *	6/2010	Puangprasert	.....	D2/879
D638,613	S *	5/2011	Romo	.....	D2/889

\* cited by examiner

*Primary Examiner* — Karen E Eldridge Powers

(74) *Attorney, Agent, or Firm* — Stoel Rives LLP

(57) **CLAIM**

I claim the ornamental design for a stitched baseball-style cap, as shown and described.

**DESCRIPTION**

FIG. 1 is an orthogonal view of a first embodiment of a stitched baseball-style cap.

FIG. 2 is a front view of the stitched baseball-style cap of FIG. 1.

FIG. 3 is a back view of the stitched baseball-style cap of FIG. 1.

FIG. 4 is a left side view of the stitched baseball-style cap of FIG. 1 of which the right side (not shown) is a mirror image.

FIG. 5 is a top view of the stitched baseball-style cap of FIG. 1.

FIG. 6 is a bottom view of the stitched baseball-style cap of FIG. 1; and,

FIG. 7 is a top view of the stitched baseball-style cap of FIG. 1 in an unfolded and unstitched condition.

The stitching shown in broken lines in the drawings forms no part of the claimed design.

**1 Claim, 3 Drawing Sheets**

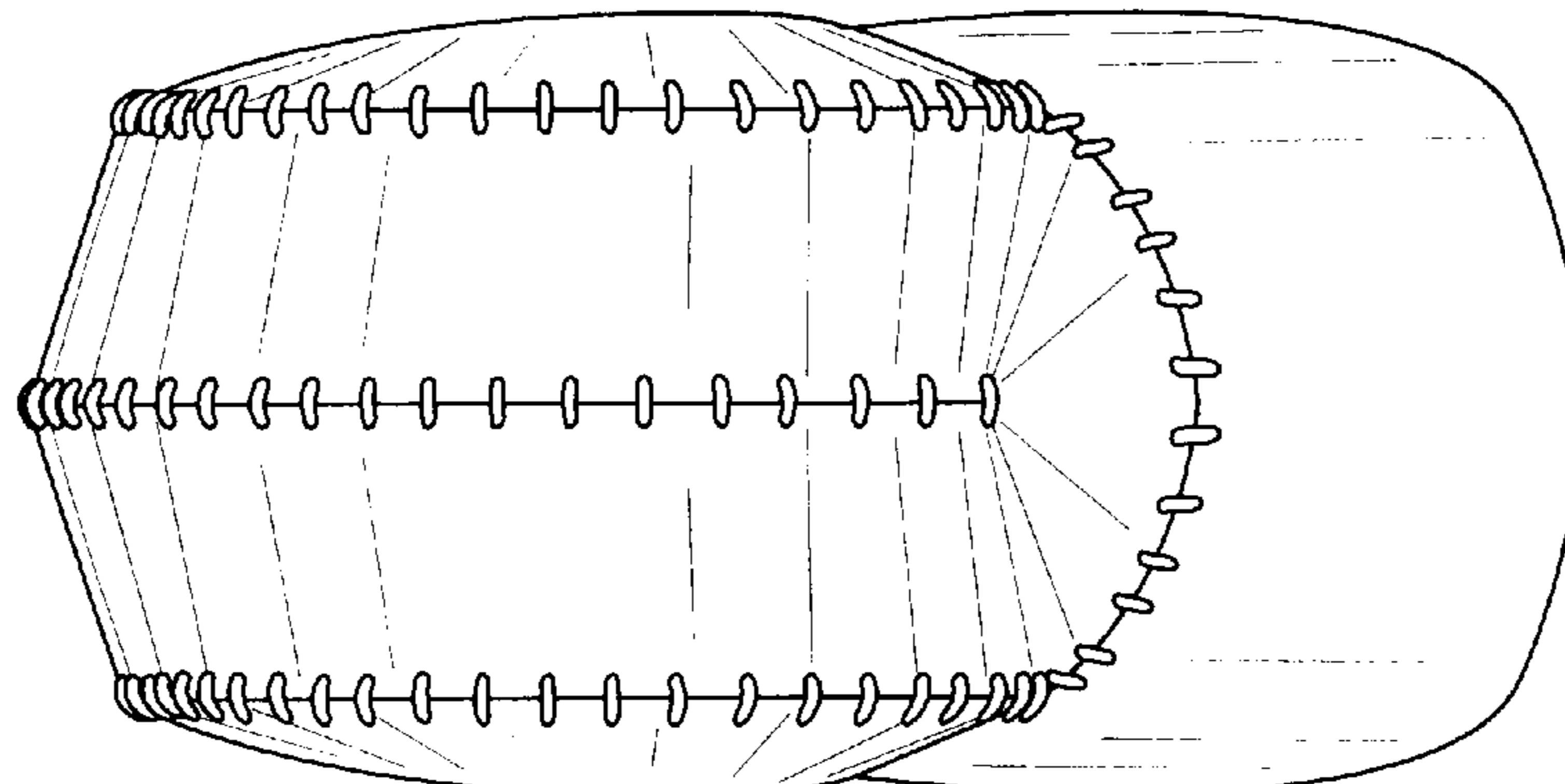
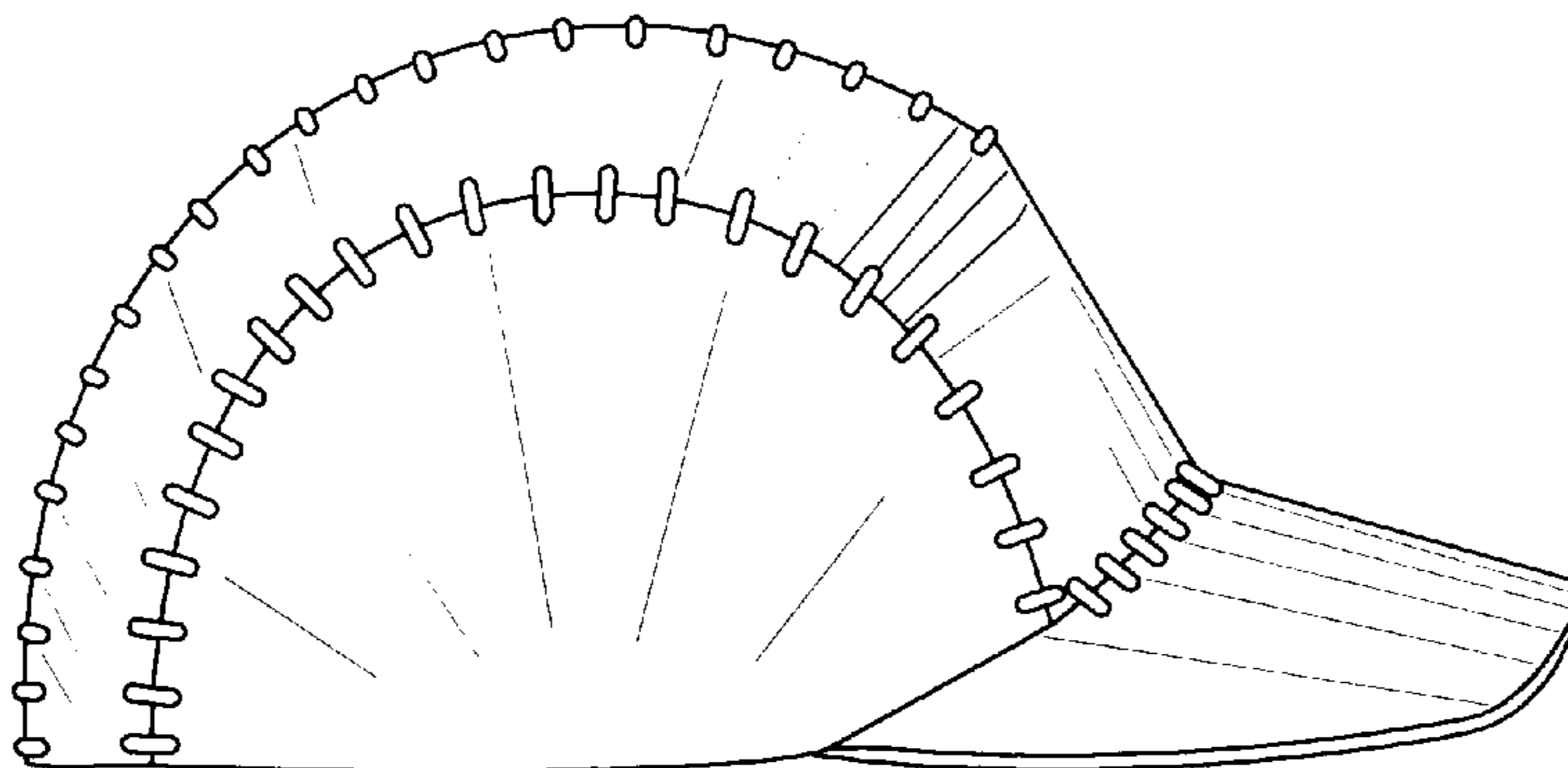

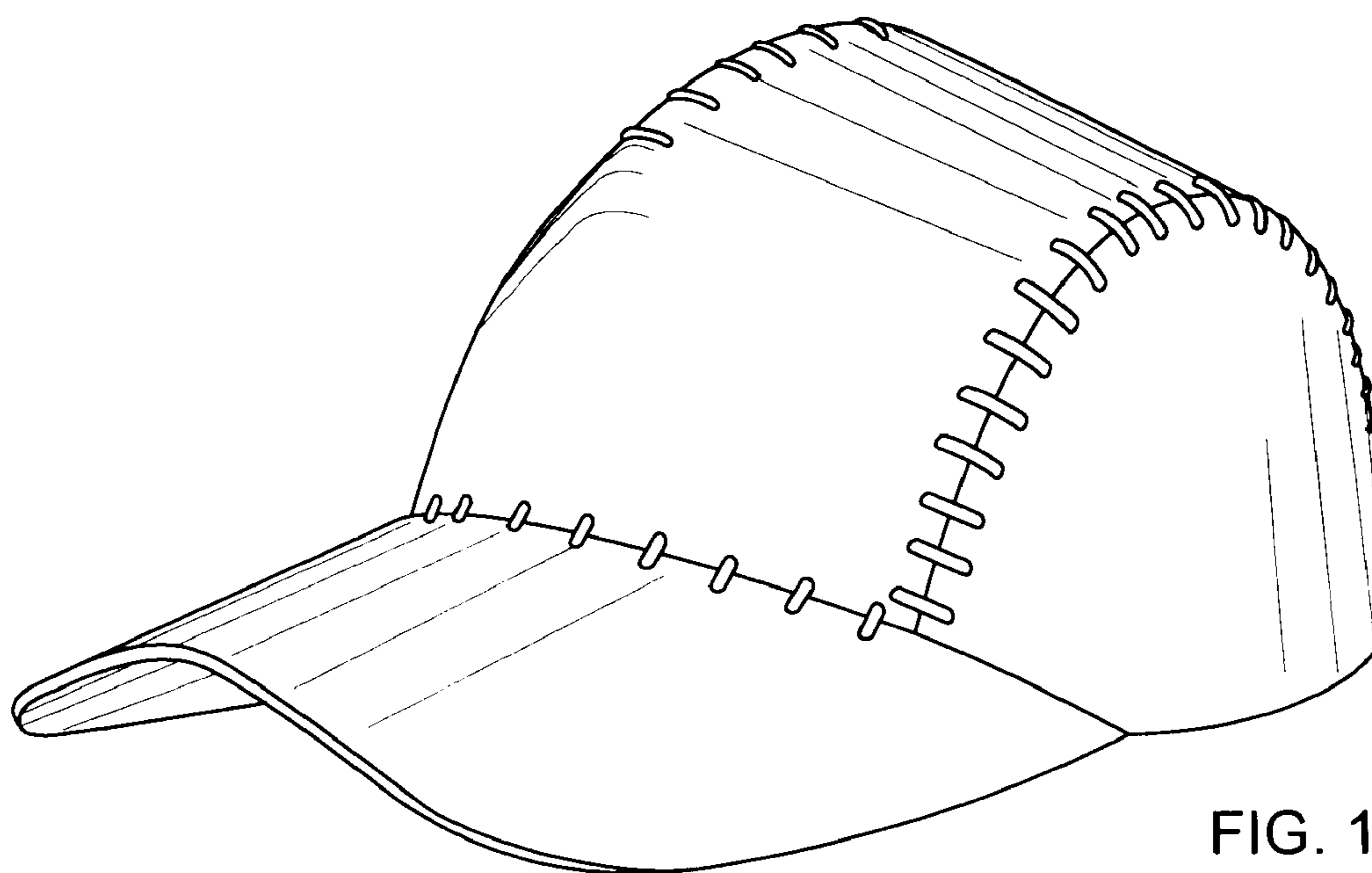

FIG. 1

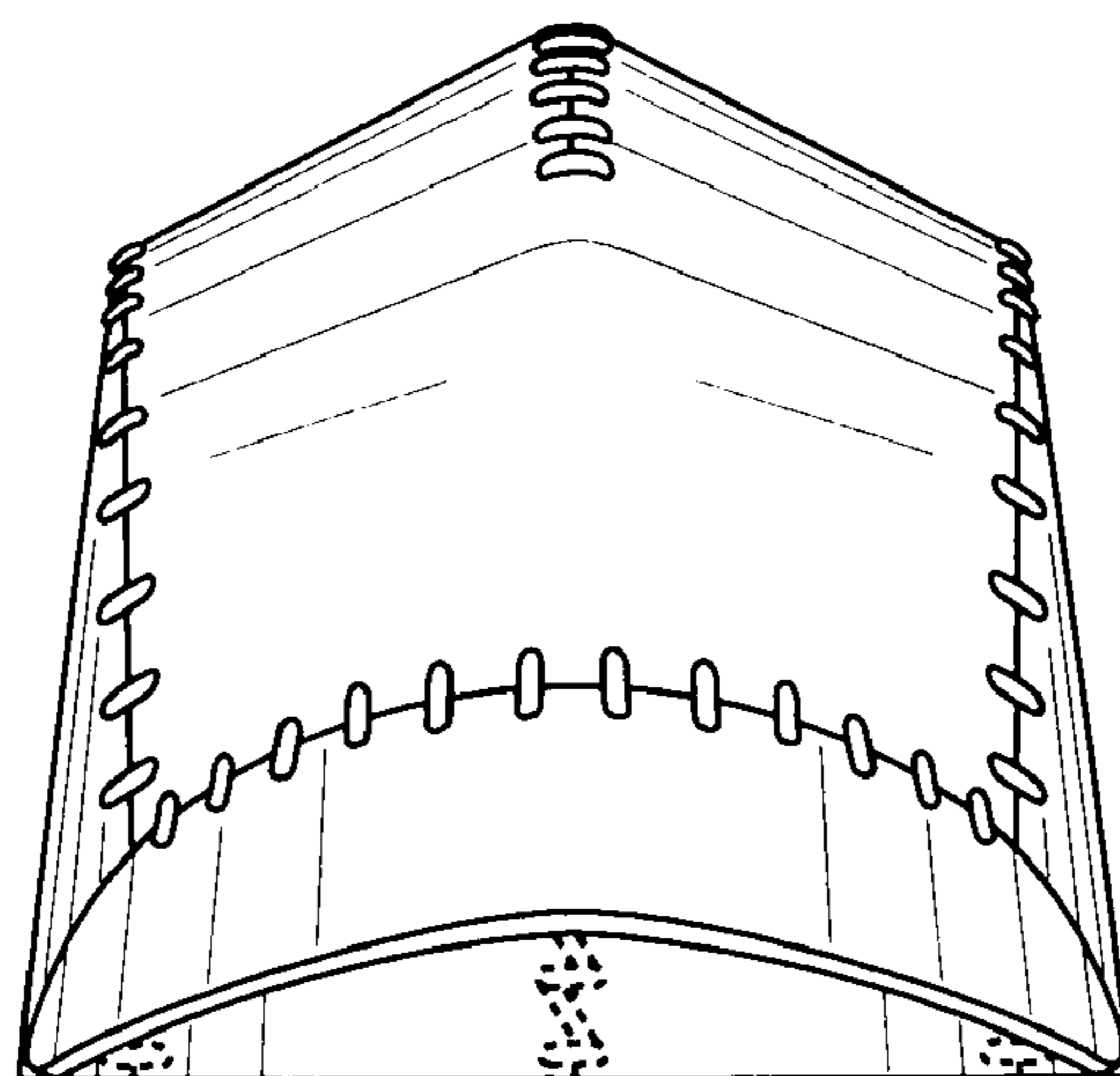

FIG. 2

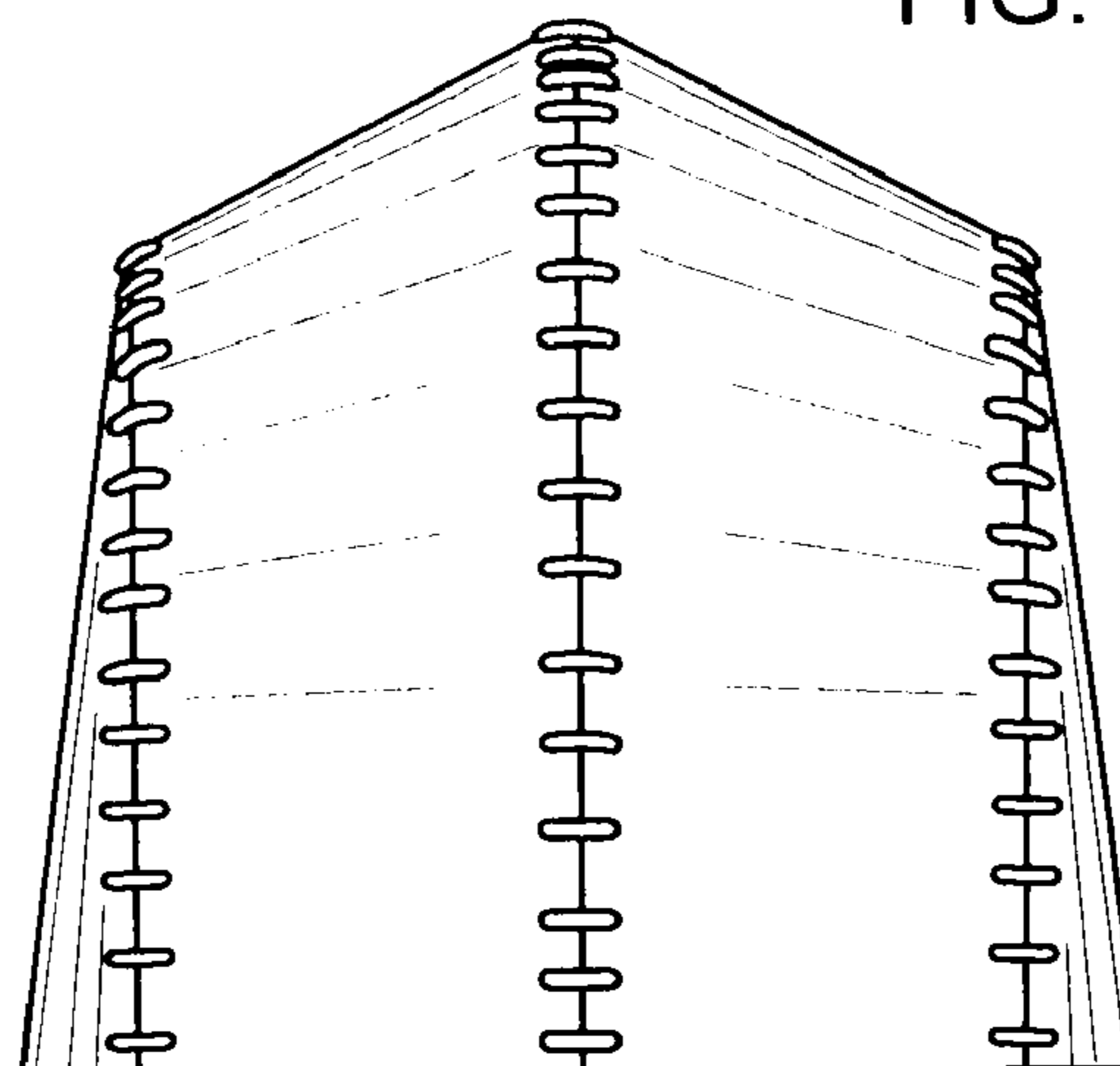

FIG. 3

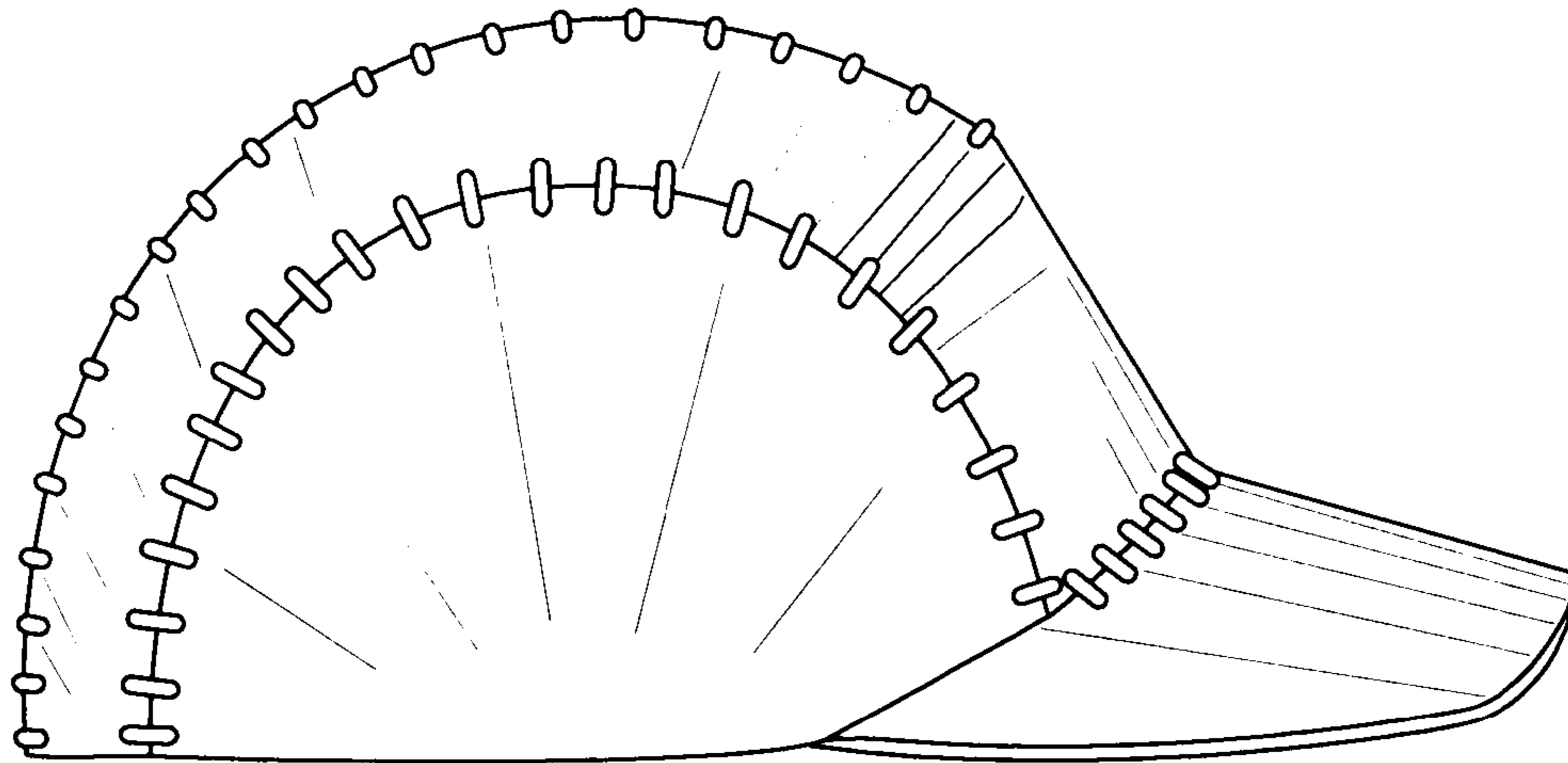

FIG. 4

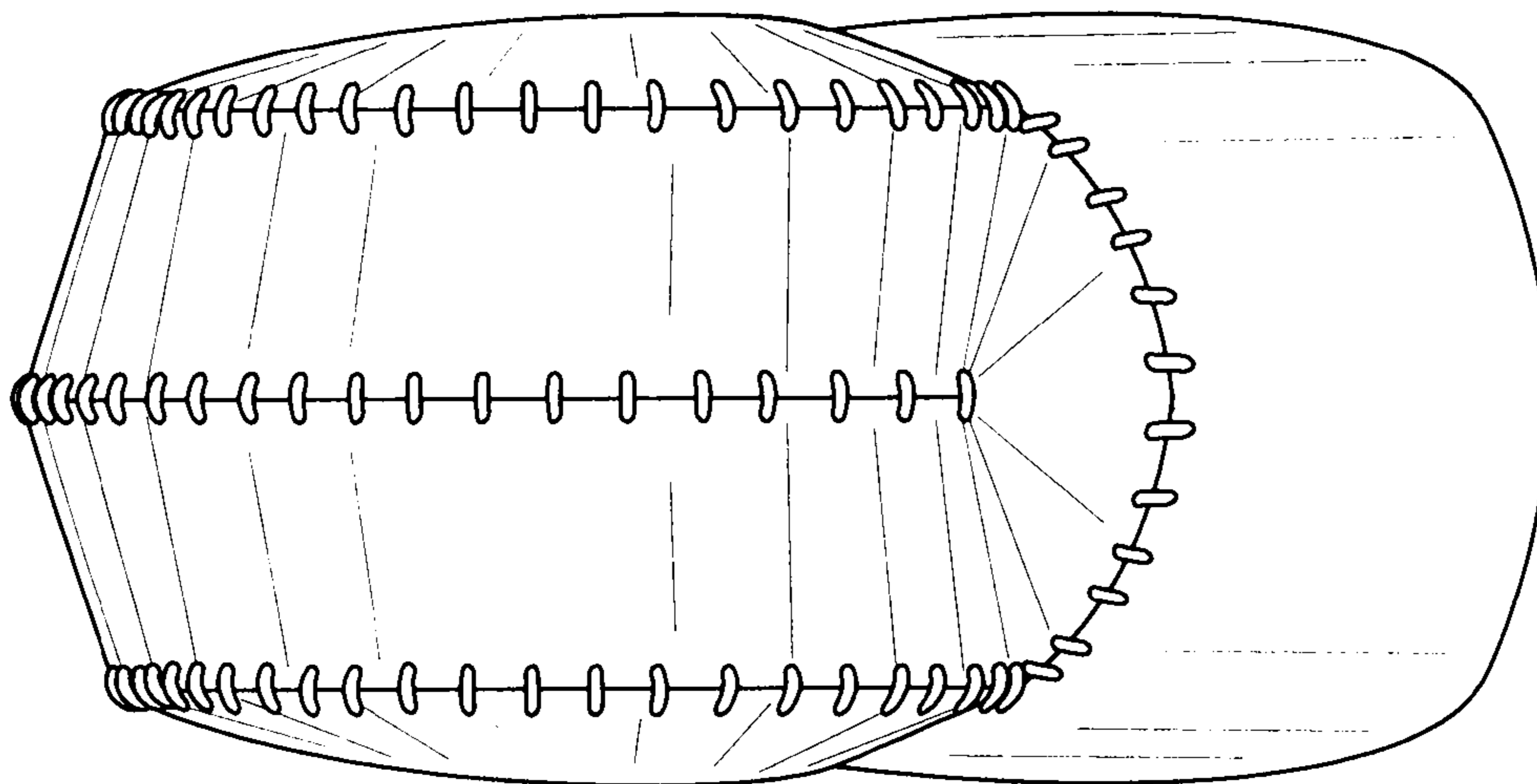

FIG. 5

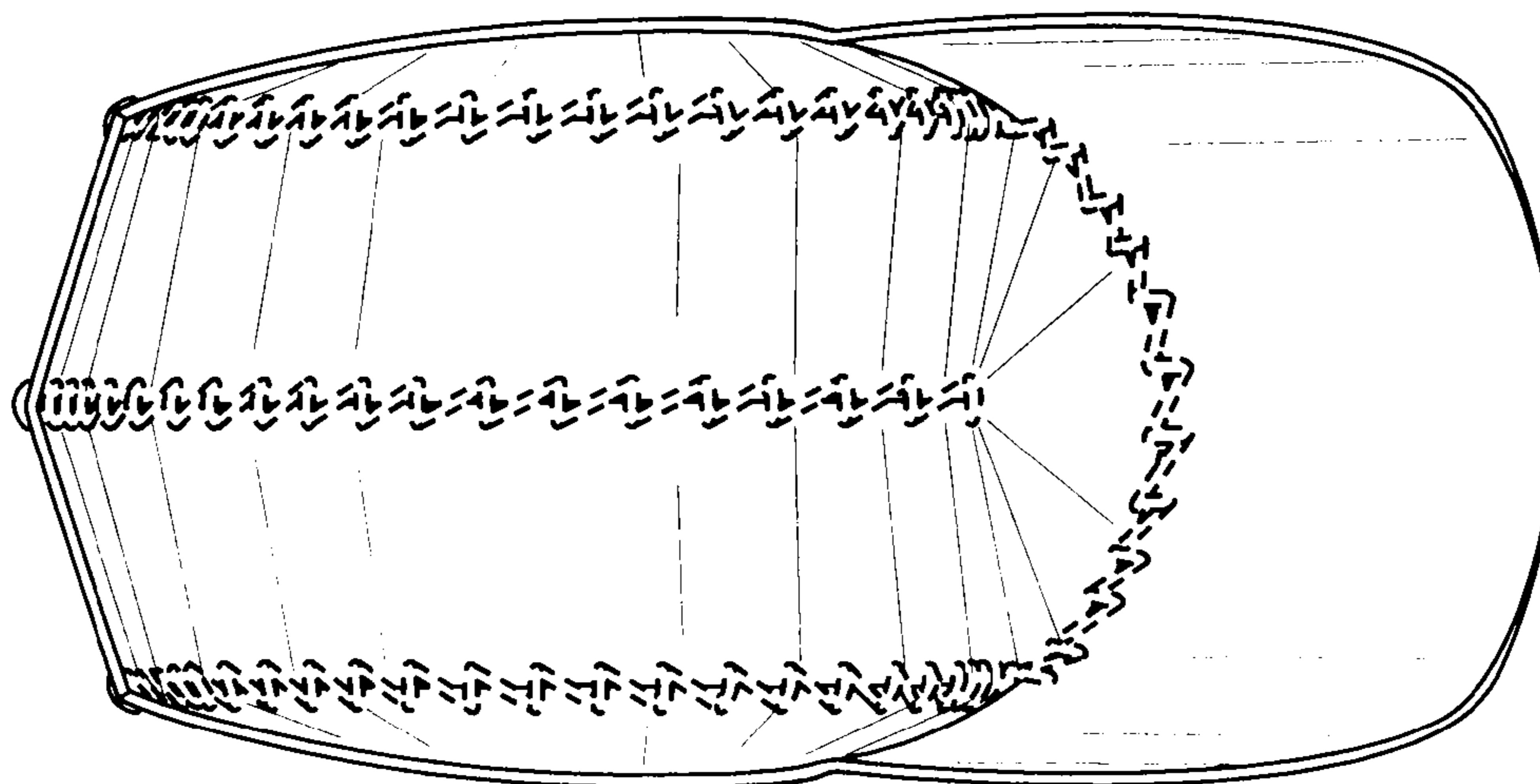

FIG. 6

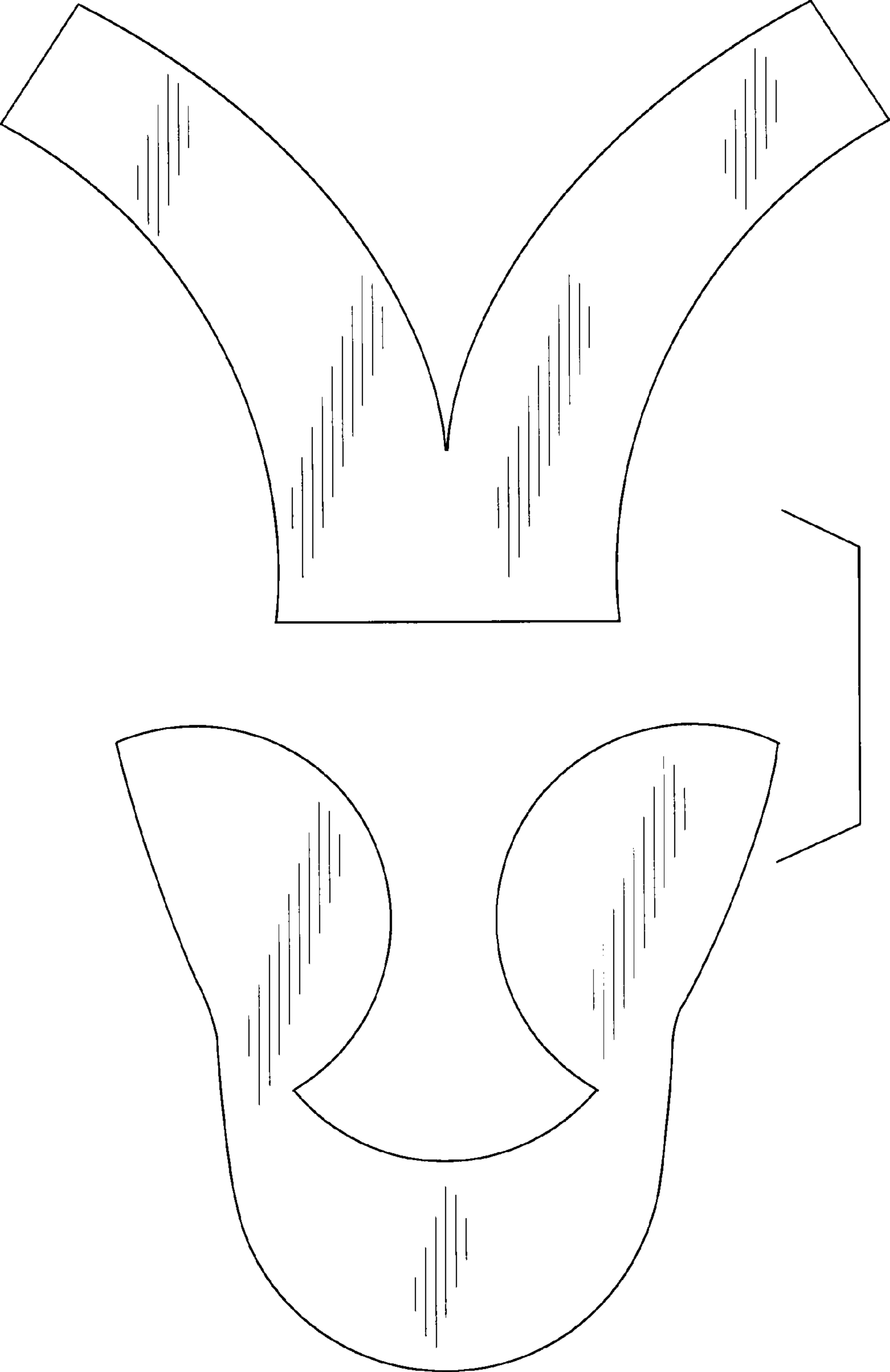

FIG. 7