



US00D657061S

(12) **United States Design Patent**  
**Wu et al.**

(10) **Patent No.:** **US D657,061 S**  
(45) **Date of Patent:** **\*\* Apr. 3, 2012**

(54) **PORTABLE ULTRASOUND DEVICE**

(75) Inventors: **Jian Wu**, Shenzhen (CN); **Jun Luo**,  
Shenzhen (CN); **Xiang Zhou**, Shenzhen  
(CN)

(73) Assignee: **Shenzhen Mindray Bio-Medical**  
**Electronics Co., Ltd.**, Shenzhen (CN)

(\*\*) Term: **14 Years**

(21) Appl. No.: **29/399,011**

(22) Filed: **Aug. 8, 2011**

(30) **Foreign Application Priority Data**

Feb. 22, 2011 (CN) ..... 2011 3 0026785

(51) **LOC (9) Cl.** ..... **24-01**

(52) **U.S. Cl.** ..... **D24/186**

(58) **Field of Classification Search** ..... D24/144,  
D24/160, 167-169, 172, 185-186, 200, 158,  
D24/164; D34/12, 14; 248/47.34, 282.1;  
606/32-34; 312/209, 223.1-223.2, 249.12;  
600/1-3, 104, 437, 443, 459  
See application file for complete search history.

(56) **References Cited**

**U.S. PATENT DOCUMENTS**

D445,189	S	*	7/2001	Cannon et al.	.....	D24/160
D454,954	S	*	3/2002	Cannon et al.	.....	D24/160
D461,895	S	*	8/2002	Barnes et al.	.....	D24/158
D503,807	S	*	4/2005	Ryan	.....	D24/200
D504,953	S	*	5/2005	Ryan	.....	D24/200
D505,726	S	*	5/2005	Ryan	.....	D24/200
D508,998	S	*	8/2005	Ryan	.....	D24/200
D509,900	S	*	9/2005	Barnes et al.	.....	D24/160
D538,432	S	*	3/2007	Diener et al.	.....	D24/160
D550,366	S	*	9/2007	Zhou et al.	.....	D24/186

D558,351	S	*	12/2007	Diener et al.	.....	D24/186
D562,456	S	*	2/2008	Scruggs et al.	.....	D24/160
D637,291	S	*	5/2011	Wu et al.	.....	D24/158
D639,434	S	*	6/2011	Wodecki et al.	.....	D24/160
2008/0208061	A1	*	8/2008	Halmann	.....	600/459
2008/0249406	A1	*	10/2008	Naruse	.....	600/437

\* cited by examiner

*Primary Examiner* — T. Chase Nelson

*Assistant Examiner* — Mark Cavanna

(74) *Attorney, Agent, or Firm* — Kory D. Christensen; Stoel Rives LLP

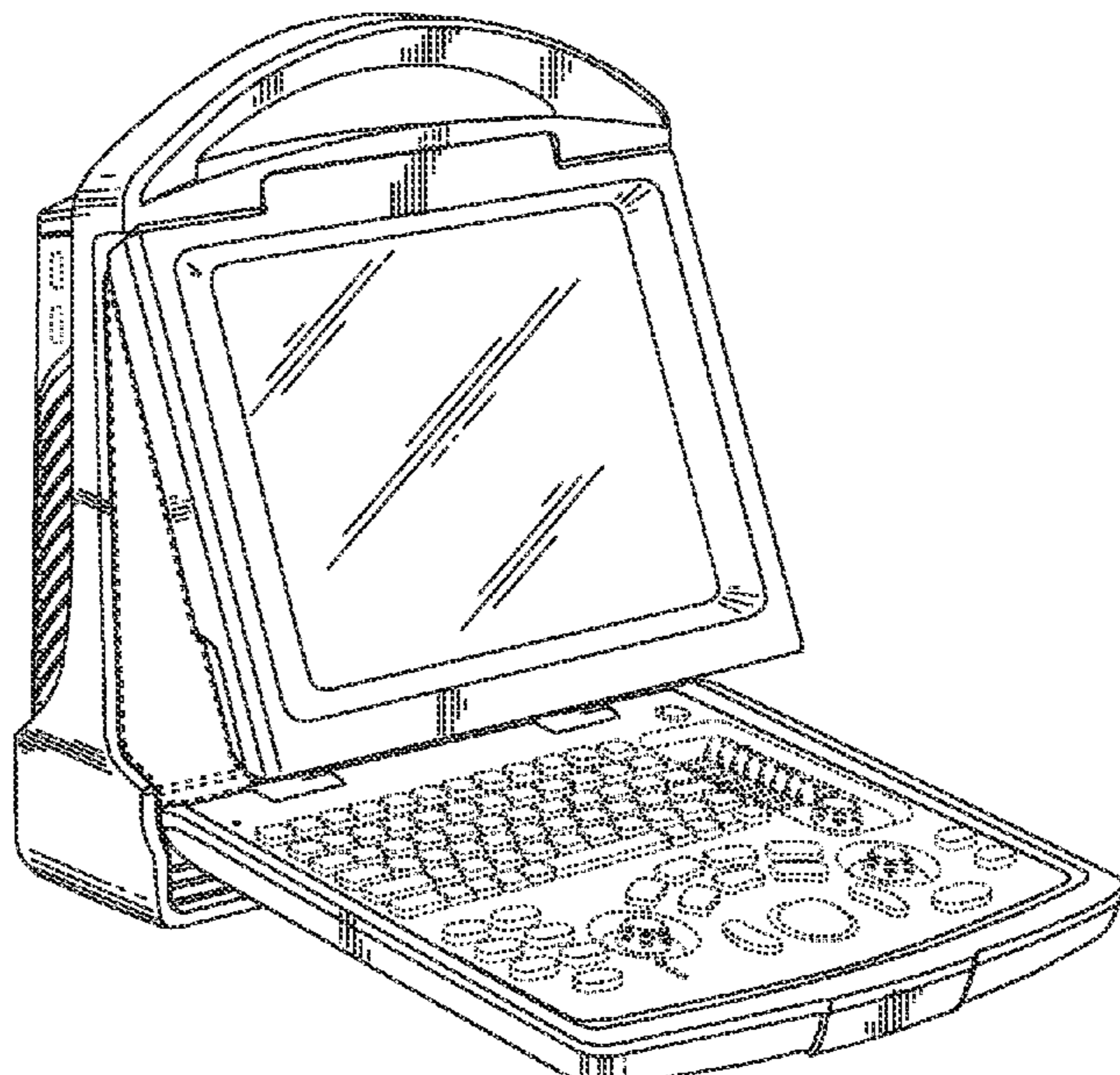
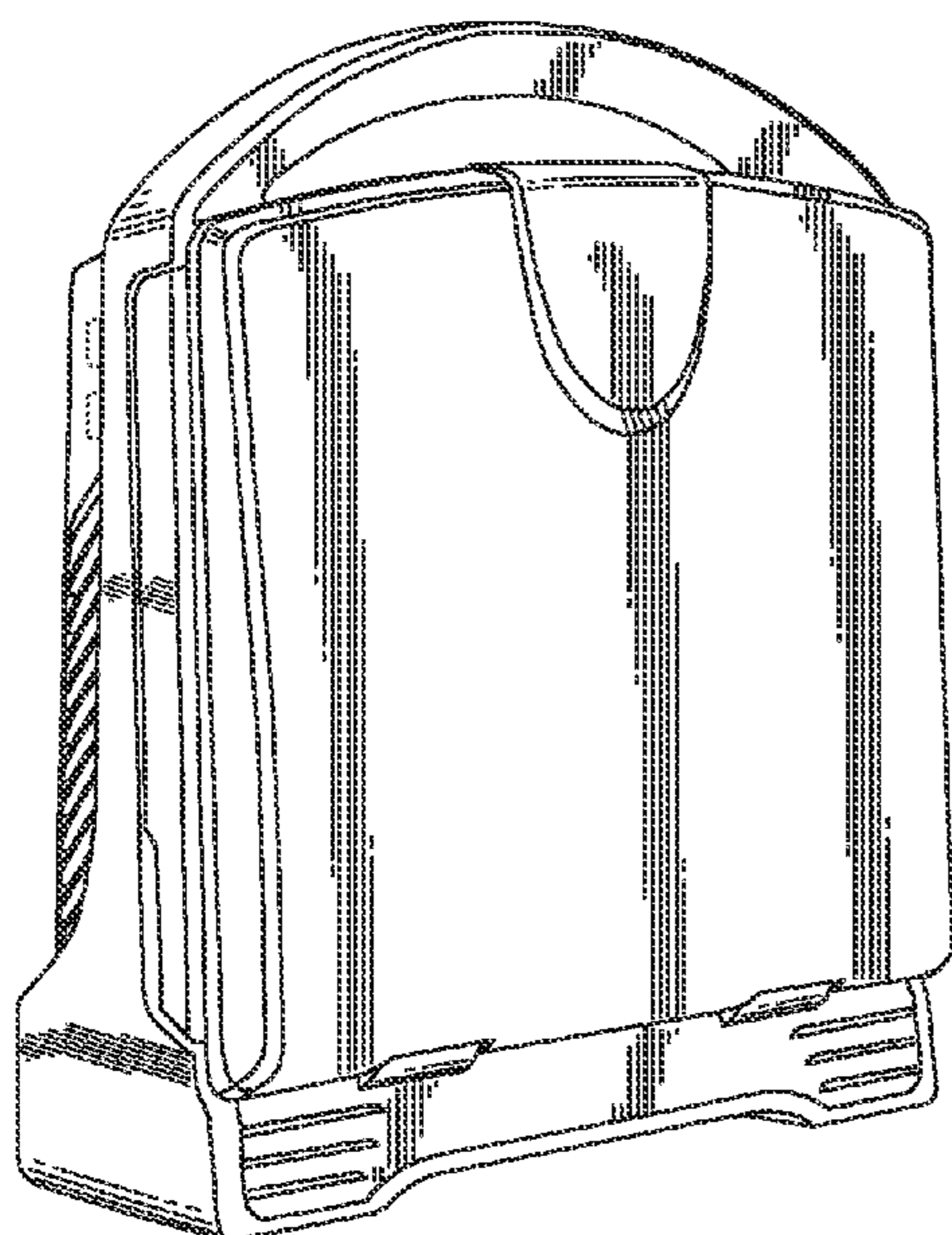
(57) **CLAIM**

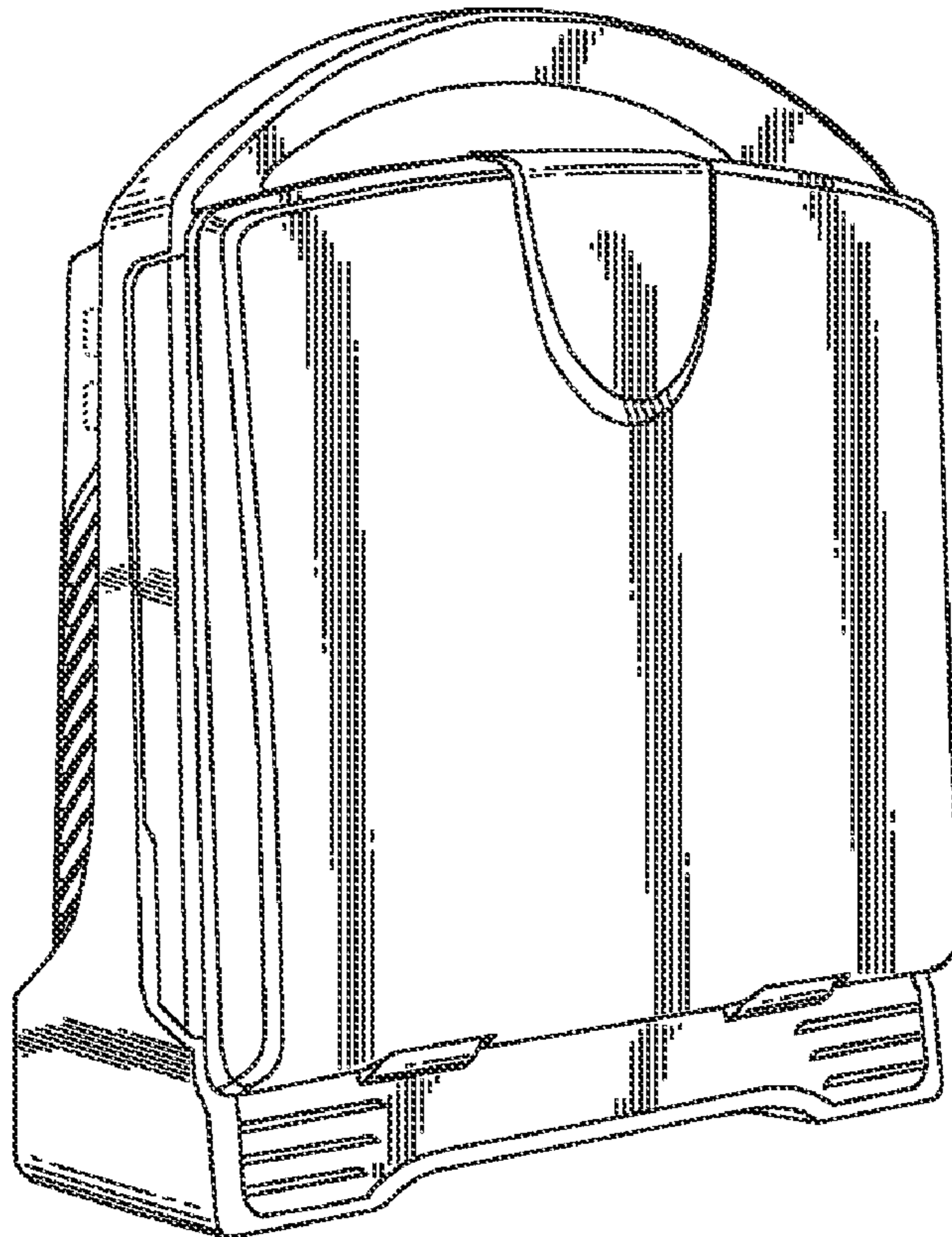
The ornamental design for a portable ultrasound device, as shown and described.

**DESCRIPTION**

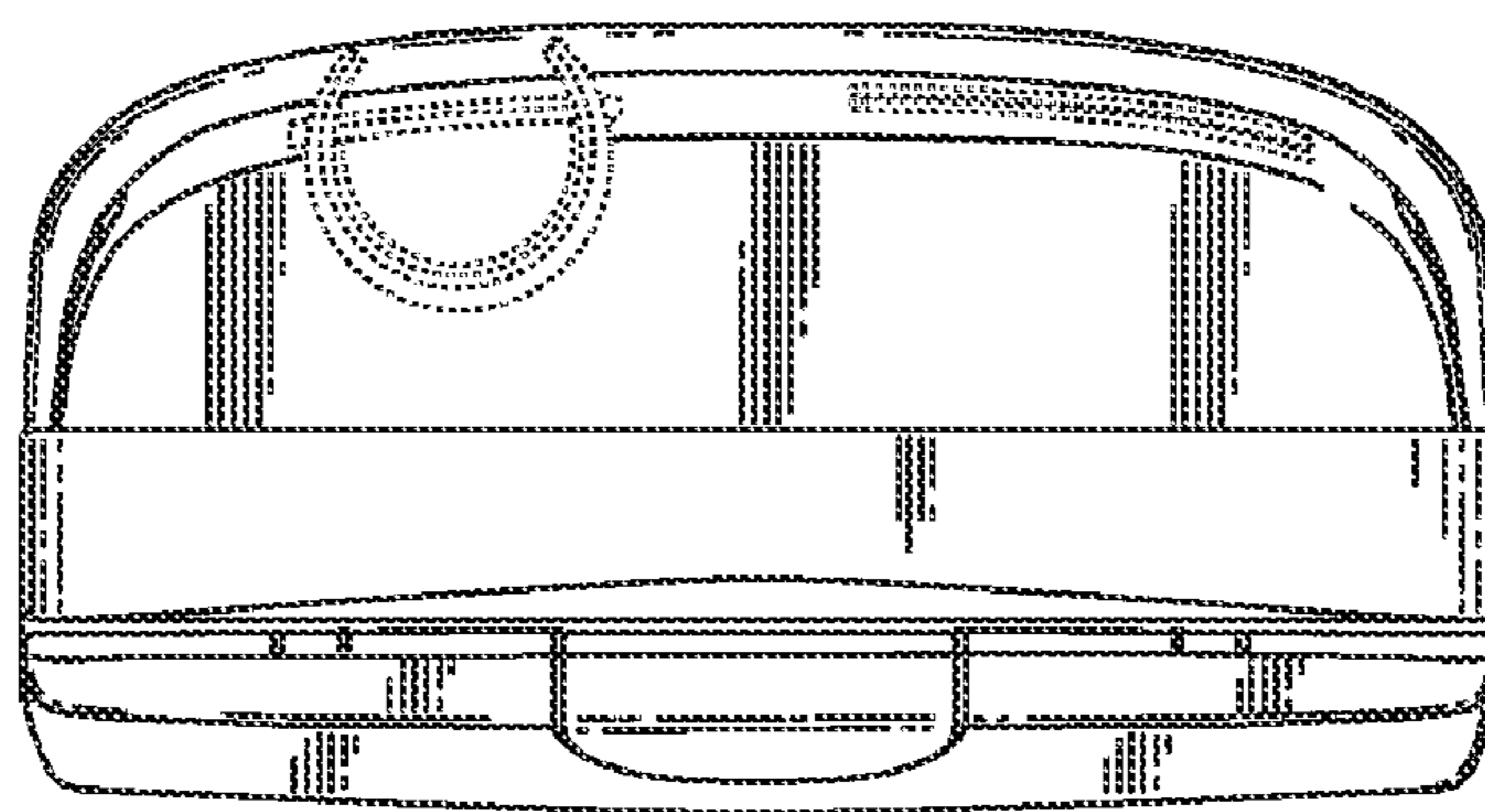
FIG. 1 is a front perspective view of a portable ultrasound device, showing our new design;  
 FIG. 2 is a top plan view thereof;  
 FIG. 3 is a front elevation view thereof;  
 FIG. 4 is a bottom plan view thereof;  
 FIG. 5 is a left side elevation view thereof;  
 FIG. 6 is a right side elevation view thereof;  
 FIG. 7 is a rear elevation view thereof;  
 FIG. 8 is a front perspective view of the portable ultrasound device shown in condition of use with the keyboard in the open position and the display screen in a vertical position; and,  
 FIG. 9 is another front perspective view of the portable ultrasound device shown in condition of use with the keyboard in the open position and the display screen in an angled position. The broken lines immediately adjacent the shaded areas represent the bounds of the claimed design, while all other broken lines are directed to environment and are for illustrative purposes only; the broken lines form no part of the claimed design.

**1 Claim, 4 Drawing Sheets**



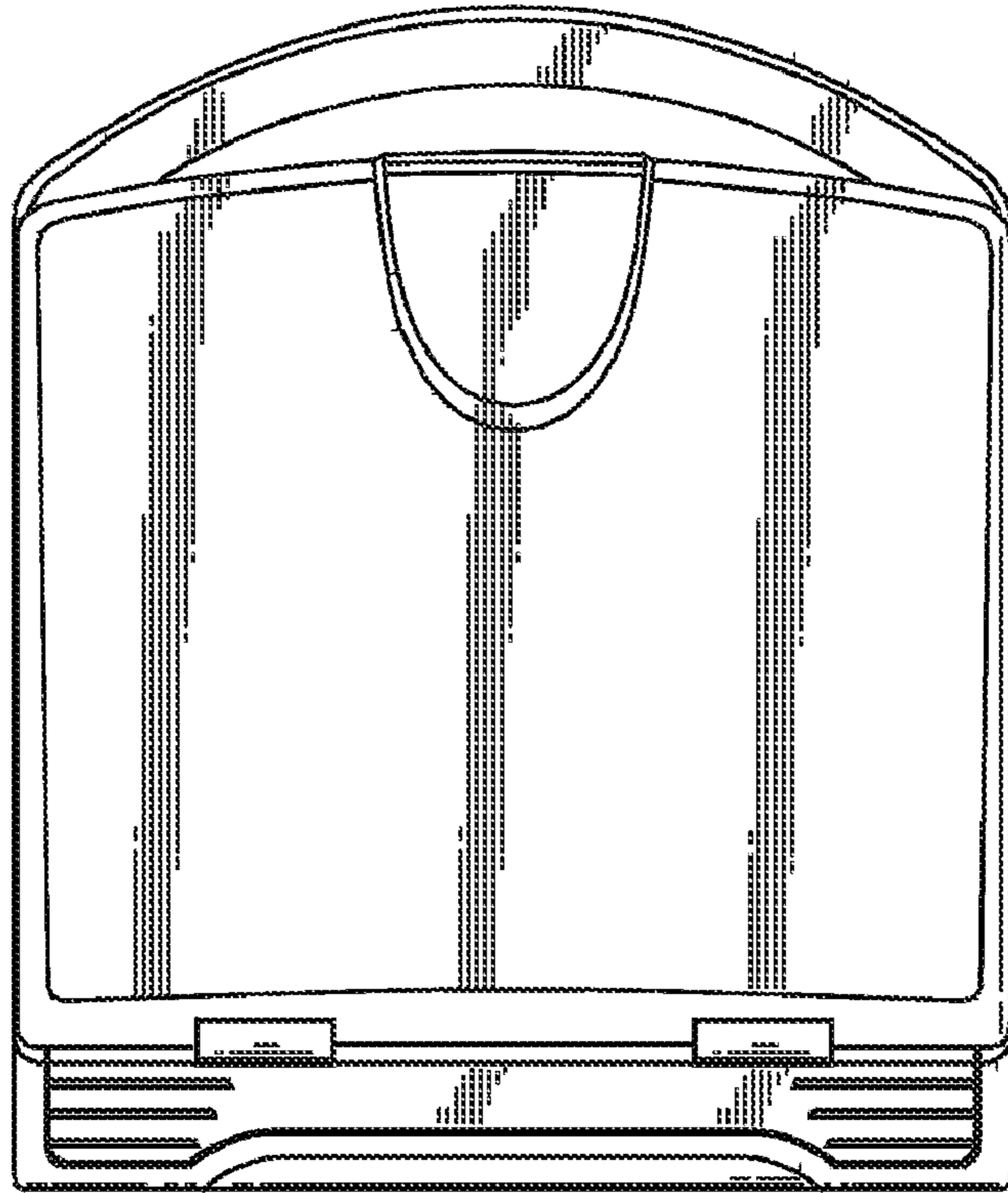


**FIG. 1**

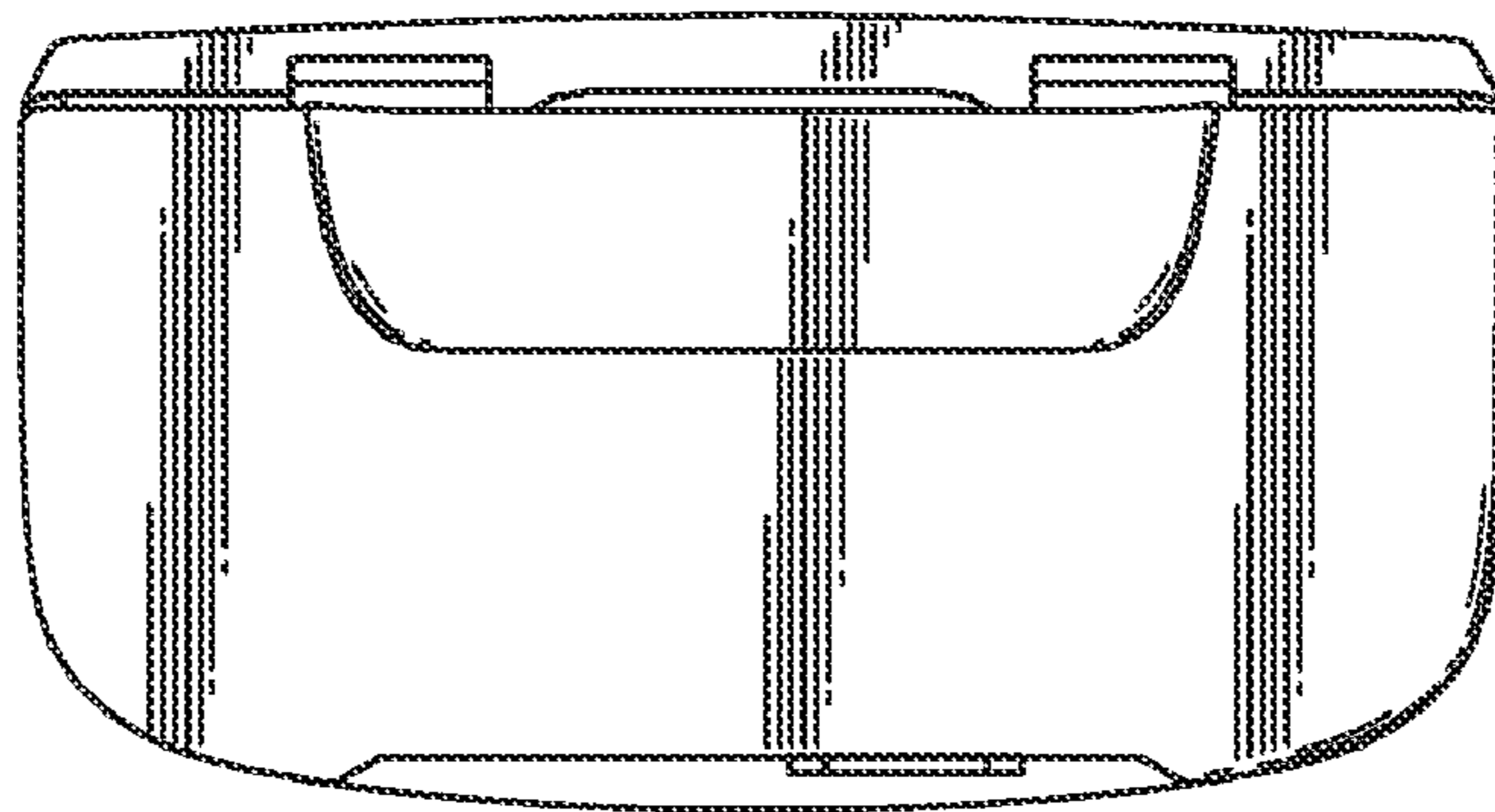


**FIG. 2**

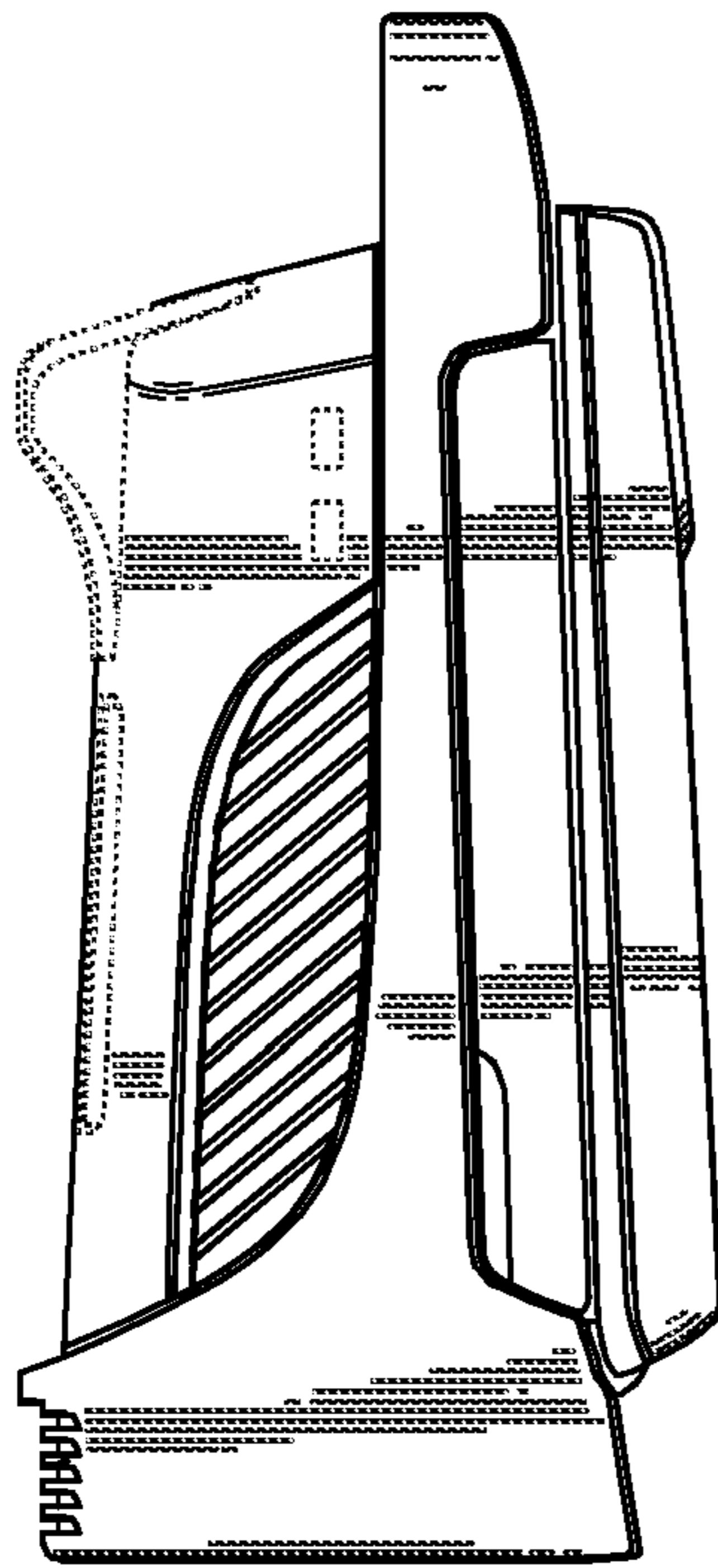




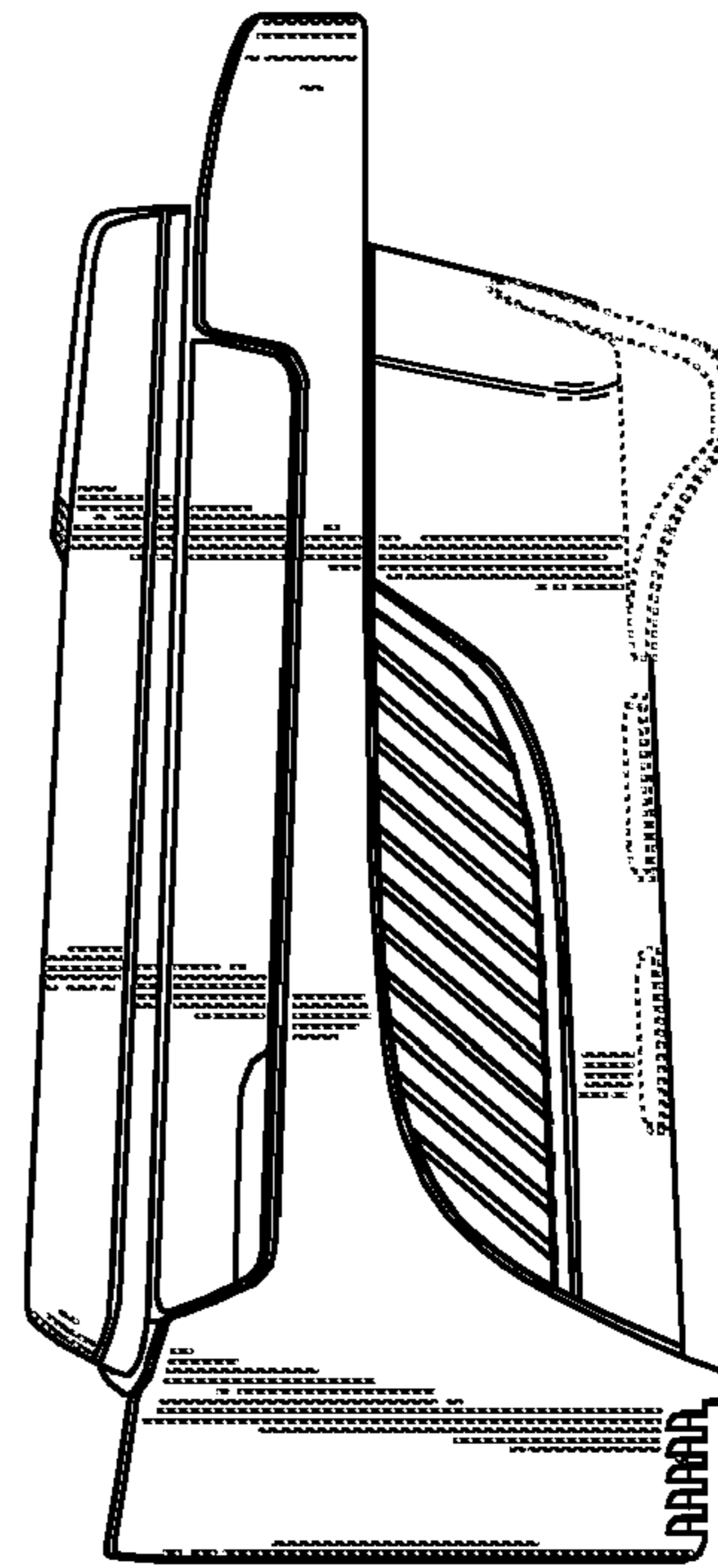
**FIG. 3**



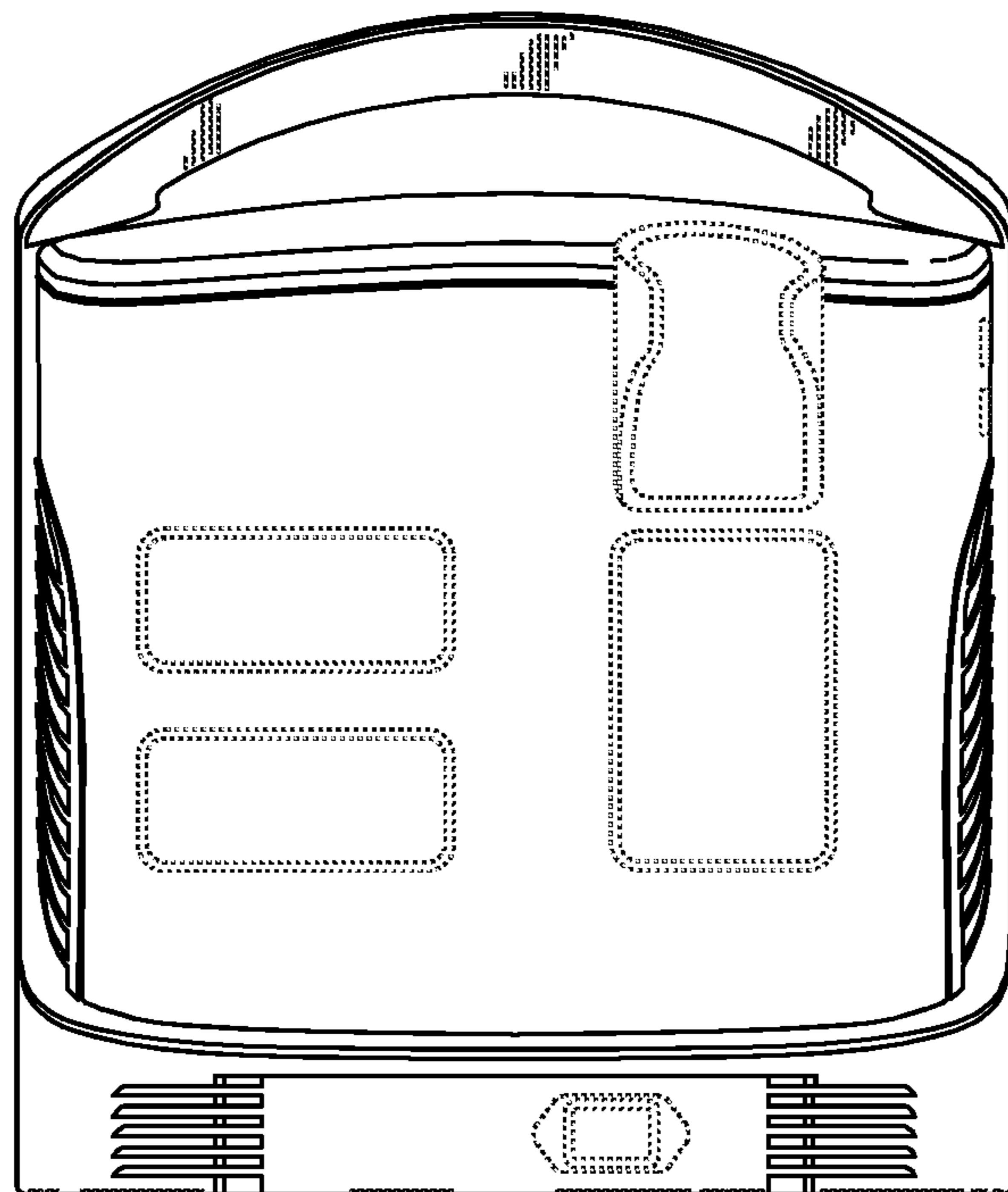
**FIG. 4**



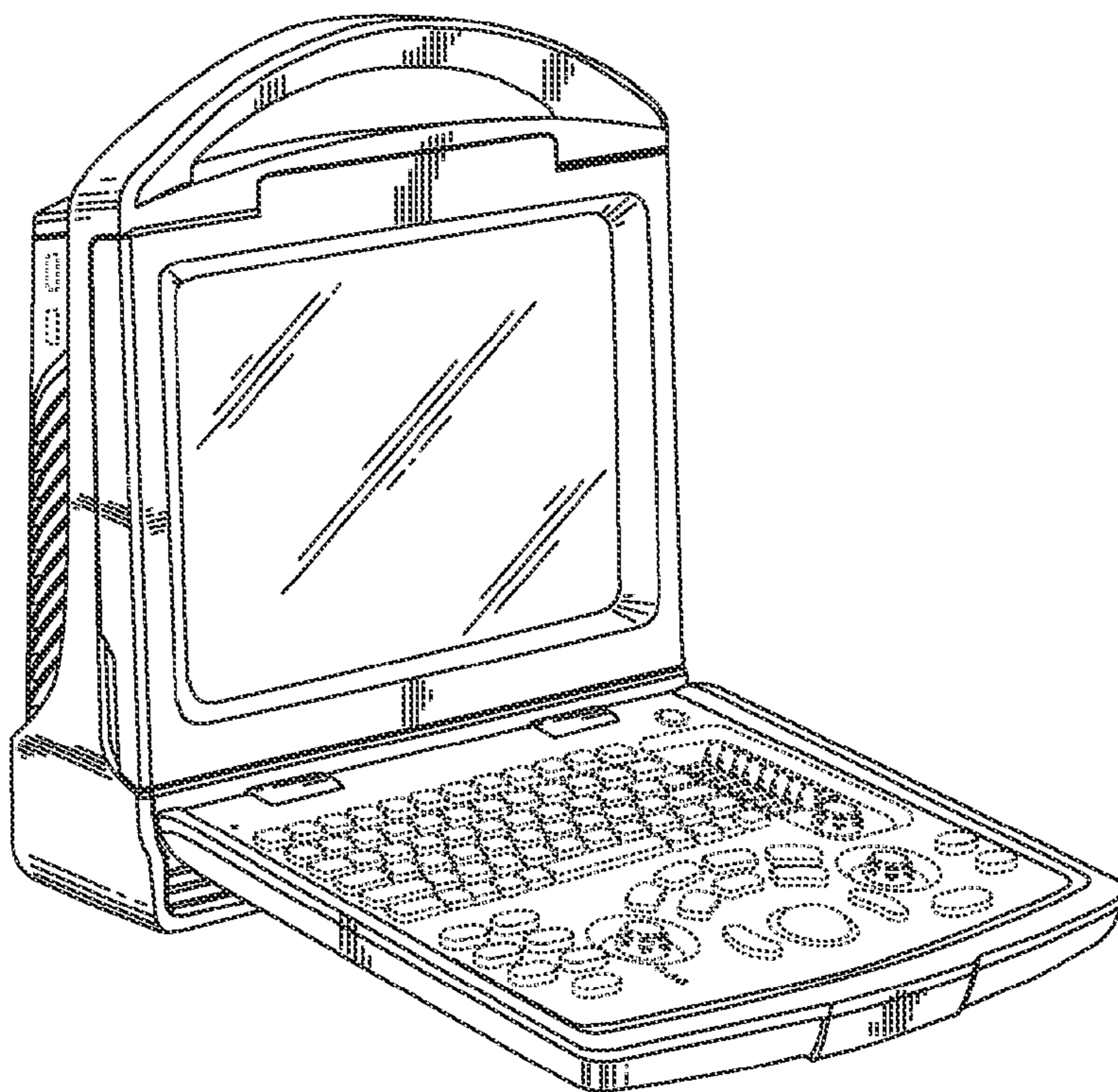
**FIG. 5**



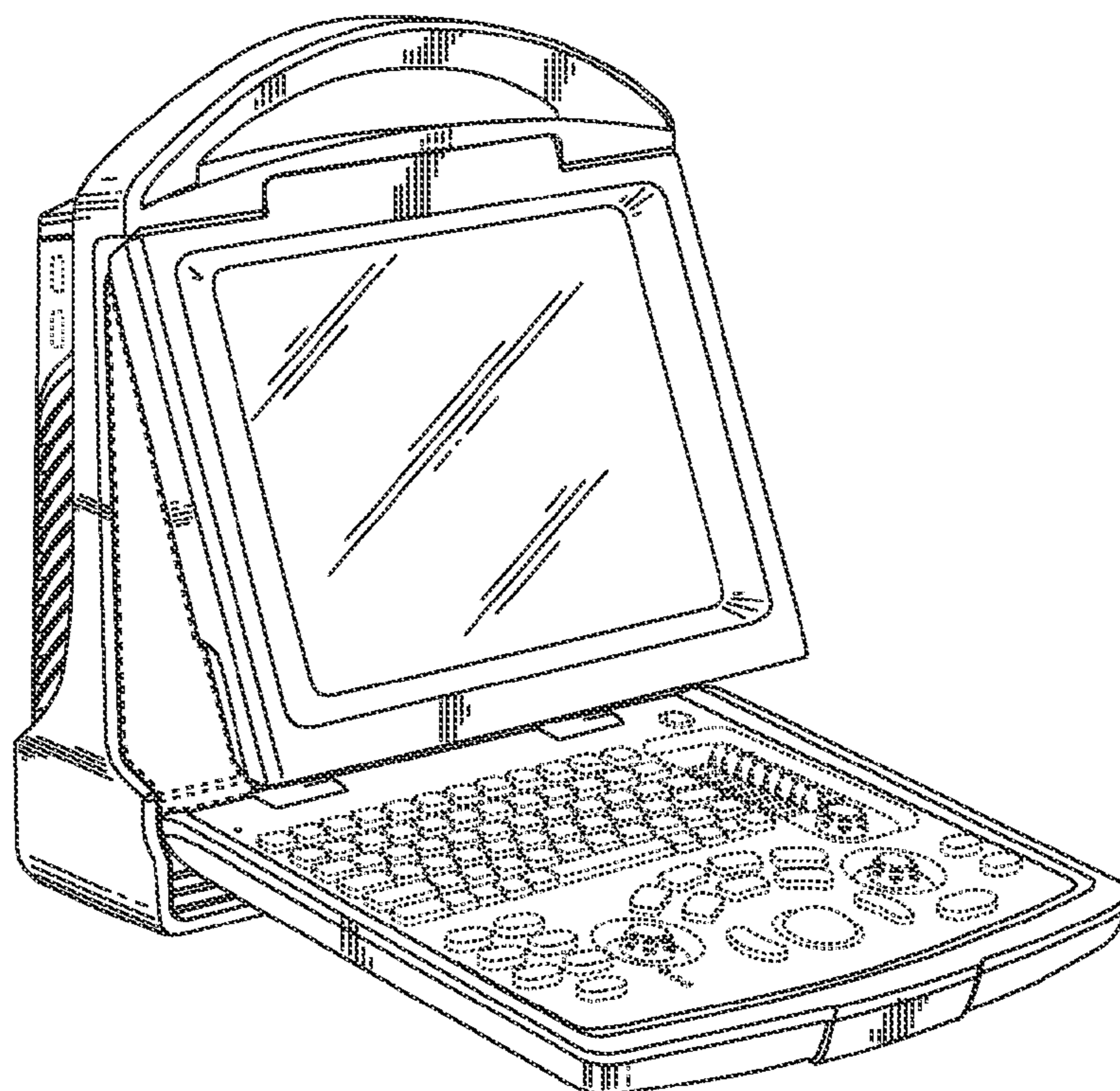
**FIG. 6**



**FIG. 7**



**FIG. 8**



**FIG. 9**