



US00D657013S

(12) **United States Design Patent**  
**Swan**

(10) **Patent No.:** **US D657,013 S**  
(45) **Date of Patent:** **\*\* Apr. 3, 2012**

(54) **FOLDING SIGHT APERTURE**

(76) Inventor: **Richard E. Swan**, E. Bridgewater, MA  
(US)

(\*\*) Term: **14 Years**

(21) Appl. No.: **29/353,276**

(22) Filed: **Jan. 6, 2010**

**Related U.S. Application Data**

(63) Continuation of application No. 11/949,421, filed on Dec. 3, 2007, which is a continuation-in-part of application No. 10/939,962, filed on Sep. 14, 2004, now Pat. No. 7,356,962.

(51) **LOC (9) Cl.** ..... **22-01**

(52) **U.S. Cl.** ..... **D22/109**

(58) **Field of Classification Search** ..... D22/108-110,  
D22/199; 89/111-133; 359/399, 823, 744;  
42/104, 105, 111-113, 116, 120, 124-126,  
42/127-129, 141-148, 133-140; 33/227,  
33/229

See application file for complete search history.

(56) **References Cited**

**U.S. PATENT DOCUMENTS**

308,699	A	12/1884	Rabbeth	
396,043	A	1/1889	Lyman	
426,887	A	4/1890	West	
561,360	A	6/1896	Taylor	
564,514	A	7/1896	Fuller	
805,770	A	11/1905	Bassell et al.	
878,857	A	2/1908	Bevier	
894,275	A *	7/1908	Marble	42/136
894,755	A	7/1908	Snedden	
1,034,925	A	8/1912	Newitt	
1,089,009	A	3/1914	Porter	
1,257,713	A	2/1918	Johnson	
1,260,907	A	3/1918	Johnson et al.	
1,276,572	A	8/1918	Rogers	
1,602,116	A	10/1926	Manahan et al.	
1,908,019	A	5/1933	Howard	
2,032,648	A	3/1936	Bliss	

2,093,676	A	9/1937	Hennessy	
2,276,446	A	3/1942	Zimmerman	
2,331,903	A	10/1943	Garand	
2,334,300	A	11/1943	Williams	
2,437,363	A	3/1948	Smith	
2,444,038	A	6/1948	Garand	
2,531,421	A *	11/1950	Garand	42/137
2,585,933	A *	2/1952	Harvey	42/137
2,724,897	A	11/1955	Hough	
2,806,288	A	9/1957	Sarvis	
2,939,217	A	6/1960	Hajek	
3,930,316	A	1/1976	Tellie	
3,969,827	A	7/1976	Ellis	
4,665,622	A	5/1987	Idan	
4,691,442	A	9/1987	Center	
4,957,211	A	9/1990	Ekkert et al.	
5,533,292	A	7/1996	Swan	
D407,788	S *	4/1999	Kay	D22/109
6,490,822	B1	12/2002	Swan	
6,568,118	B1	5/2003	Teetzel	

(Continued)

**FOREIGN PATENT DOCUMENTS**

DE 151669 6/1904

(Continued)

*Primary Examiner* — Michael Pratt

(74) *Attorney, Agent, or Firm* — Barlow, Josephs & Holmes, Ltd.

(57) **CLAIM**

The ornamental design for a folding sight aperture, as shown and described.

**DESCRIPTION**

FIG. 1 is a perspective view of a folding sight aperture in accordance with the present invention;  
FIG. 2 is a front view thereof;  
FIG. 3 is a rear view thereof;  
FIG. 4 is a left side view thereof;  
FIG. 5 is a right side view thereof;  
FIG. 6 is a top view thereof; and,  
FIG. 7 is a bottom view thereof.

**1 Claim, 6 Drawing Sheets**

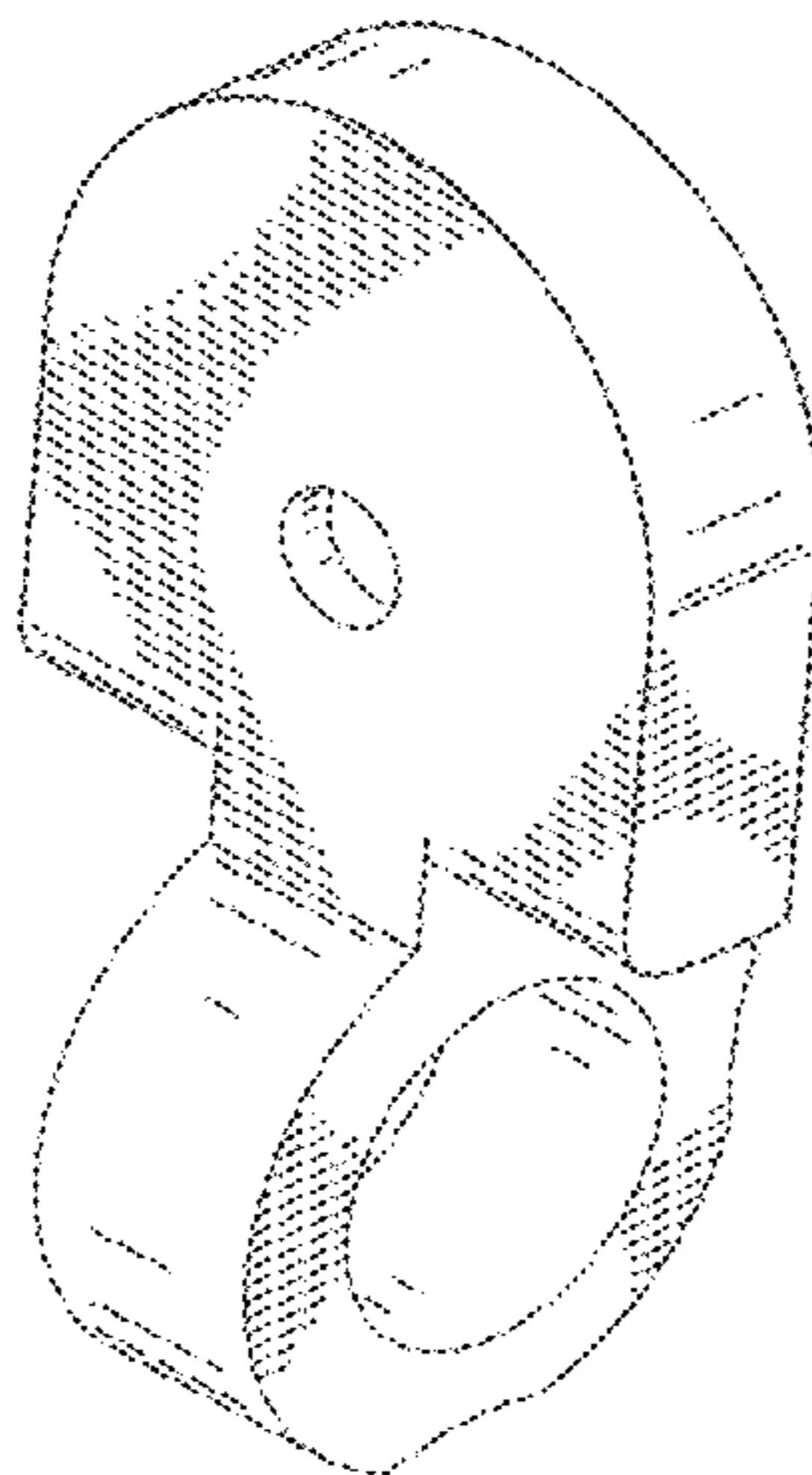

# US D657,013 S

Page 2

---

## U.S. PATENT DOCUMENTS

6,606,813 B1 8/2003 Squire et al.  
6,615,530 B2 9/2003 Johansson  
6,622,415 B1 9/2003 Canaday et al.  
6,722,075 B1 4/2004 Gabaldon  
6,732,467 B1 5/2004 Luth  
6,779,290 B1 8/2004 Houtsma  
D508,726 S \* 8/2005 Storch ..... D22/108  
6,968,643 B2 11/2005 Woodbury  
7,076,907 B2 7/2006 Nesseth et al.

D526,380 S 8/2006 Swan  
7,181,882 B2 2/2007 Woodbury  
D594,083 S \* 6/2009 Mayberry et al. .... D22/109  
D602,113 S \* 10/2009 Ballard ..... D22/110  
D602,114 S \* 10/2009 Ballard ..... D22/110  
2003/0140546 A1 7/2003 Kay

## FOREIGN PATENT DOCUMENTS

GB 169397 8/1921

\* cited by examiner

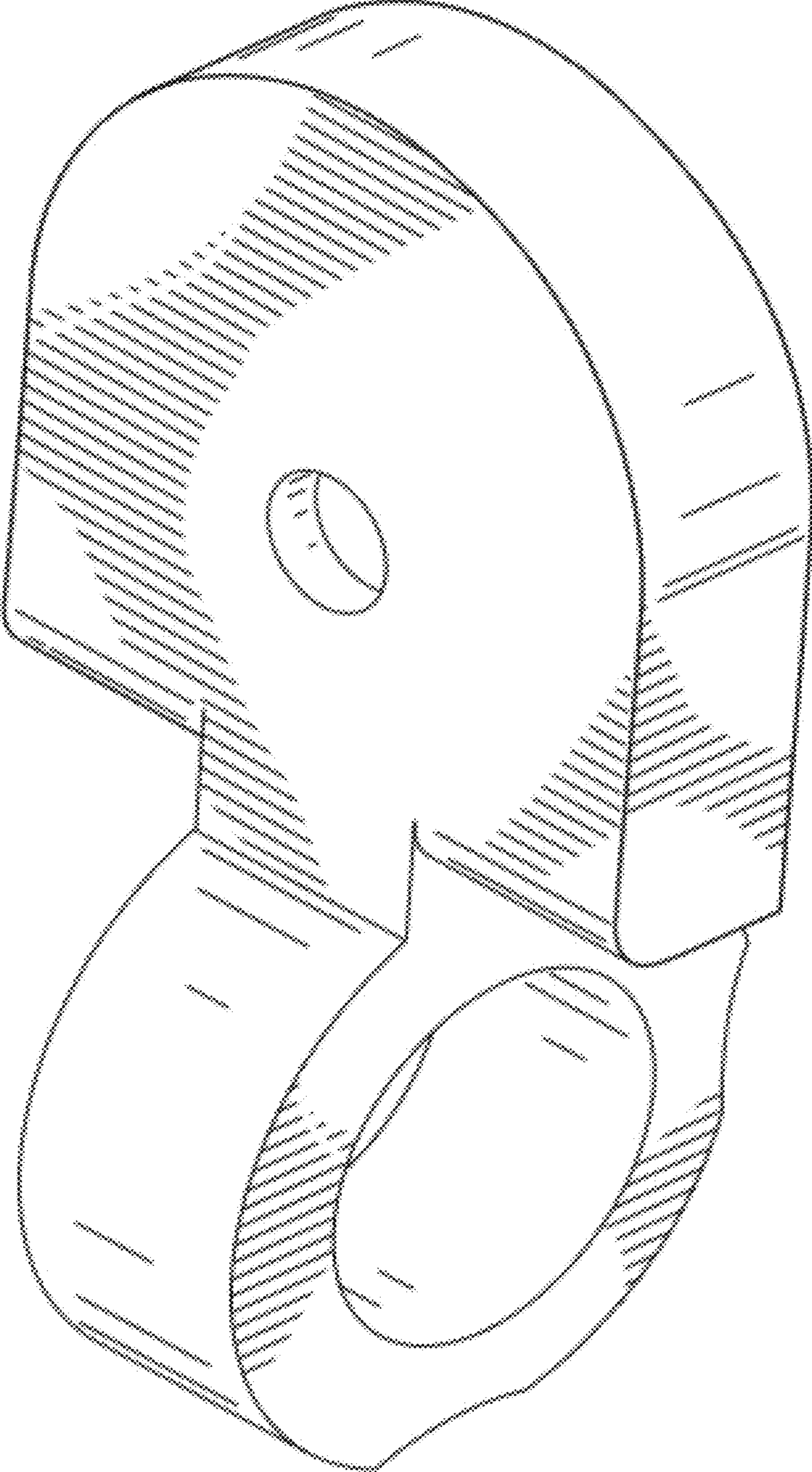

FIG. 1

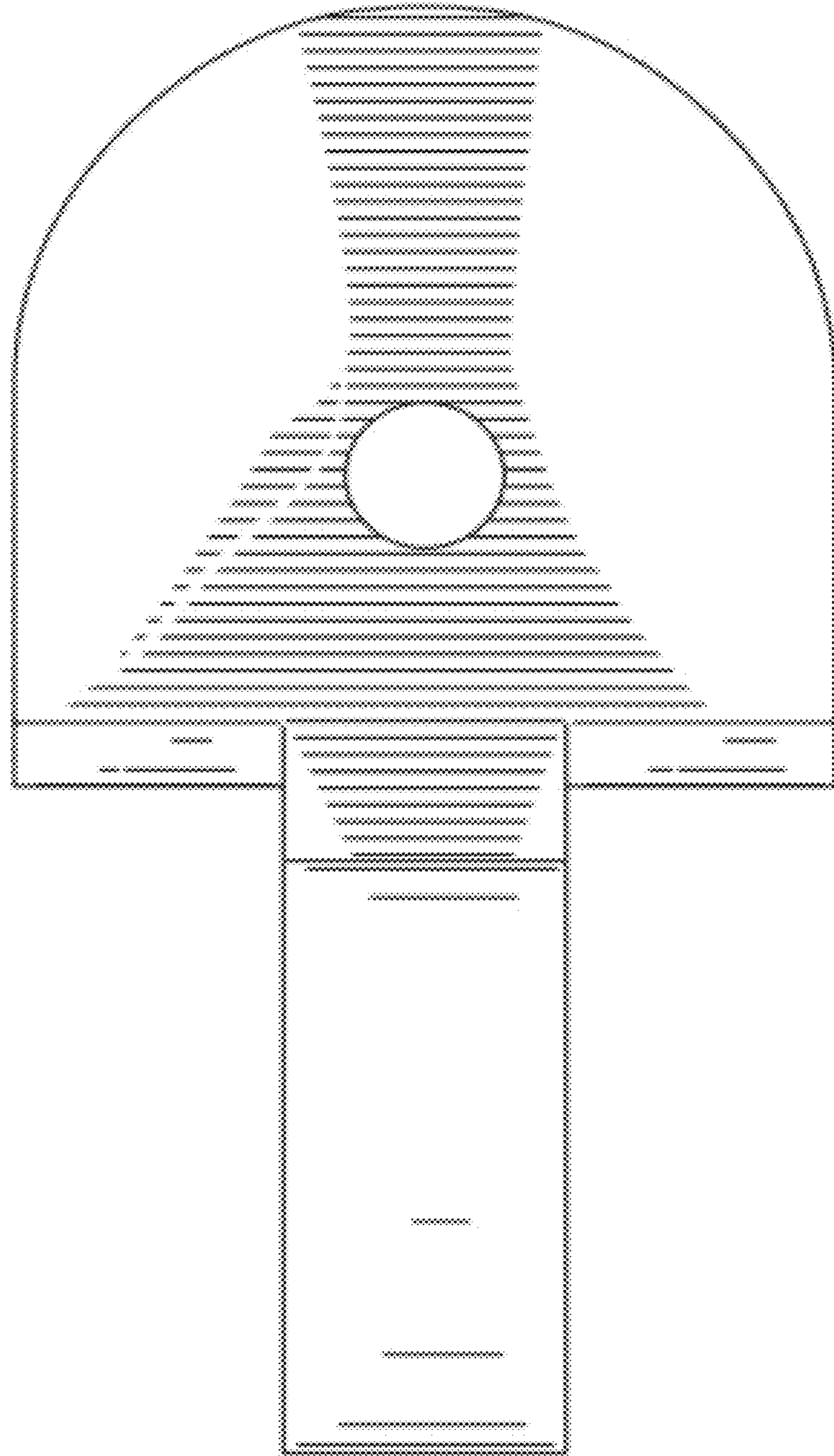

FIG. 2

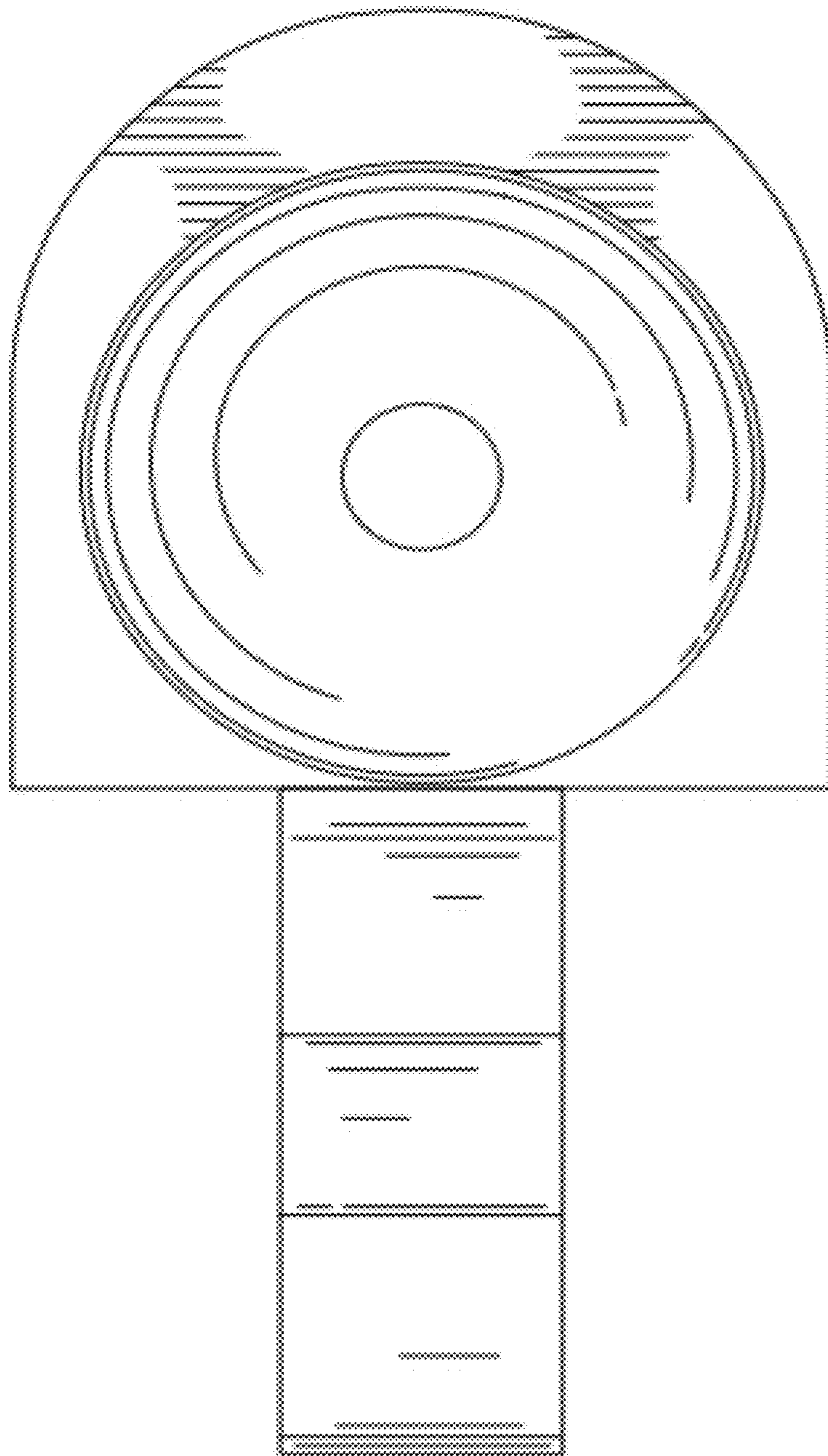

FIG. 3

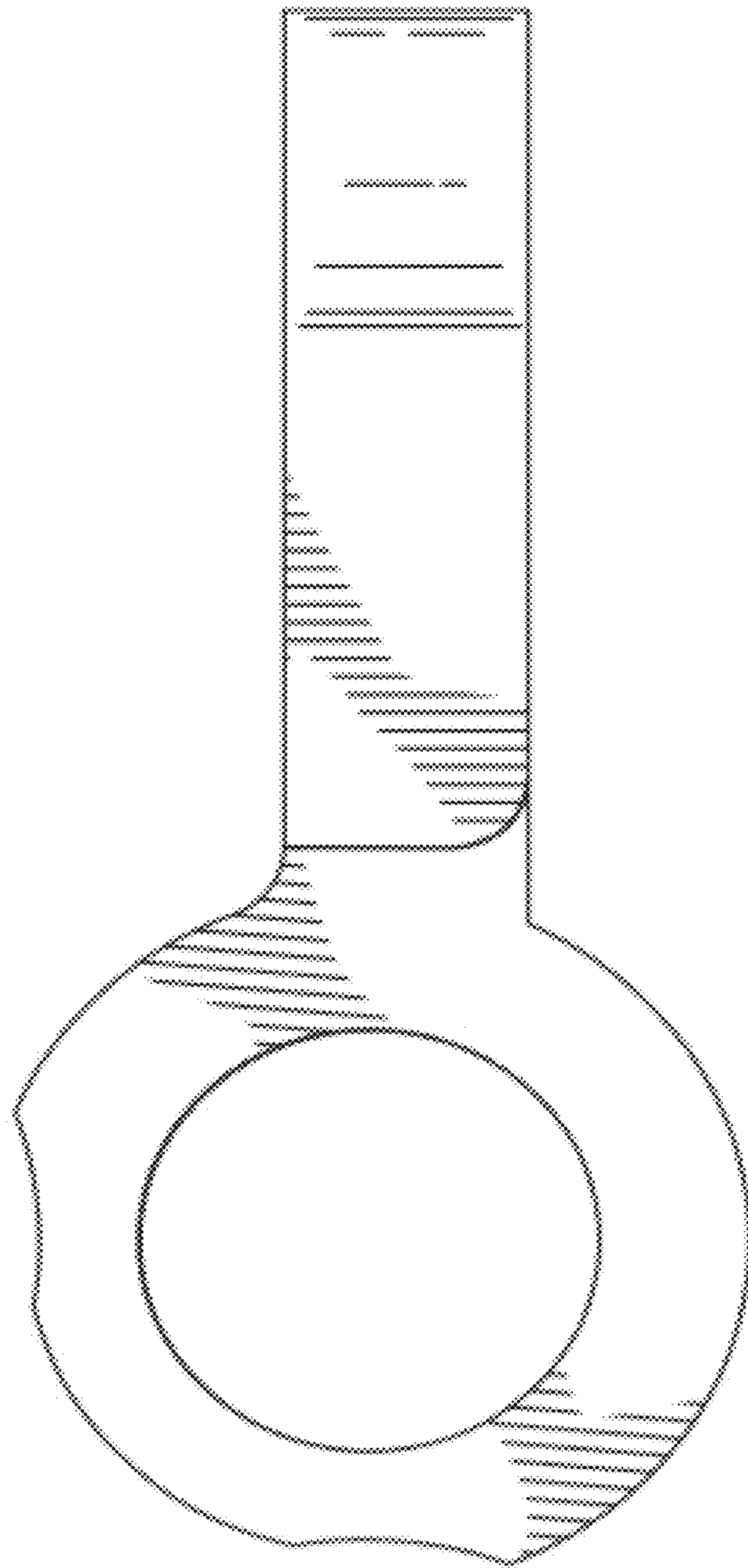

FIG. 4

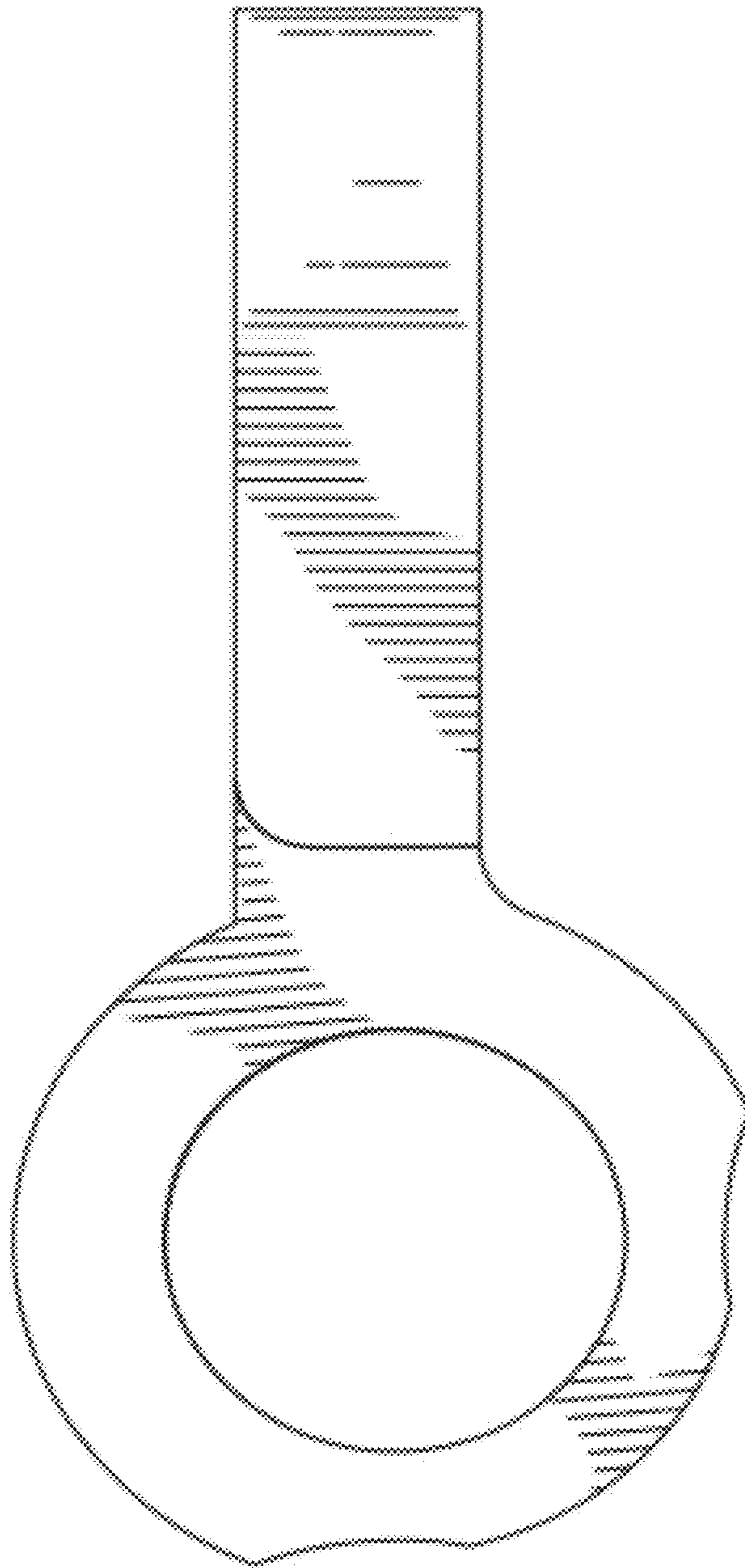

FIG. 5

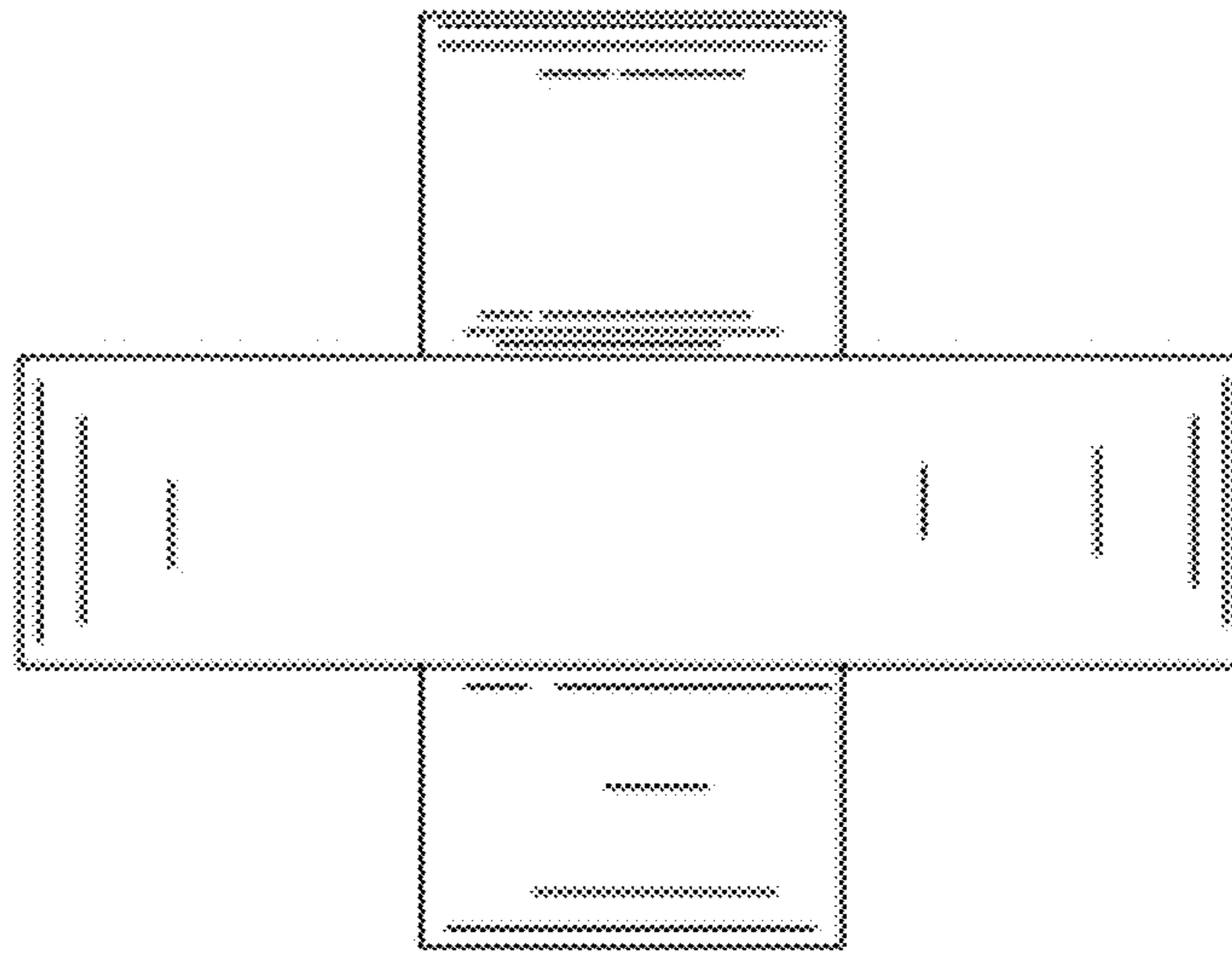

FIG. 6

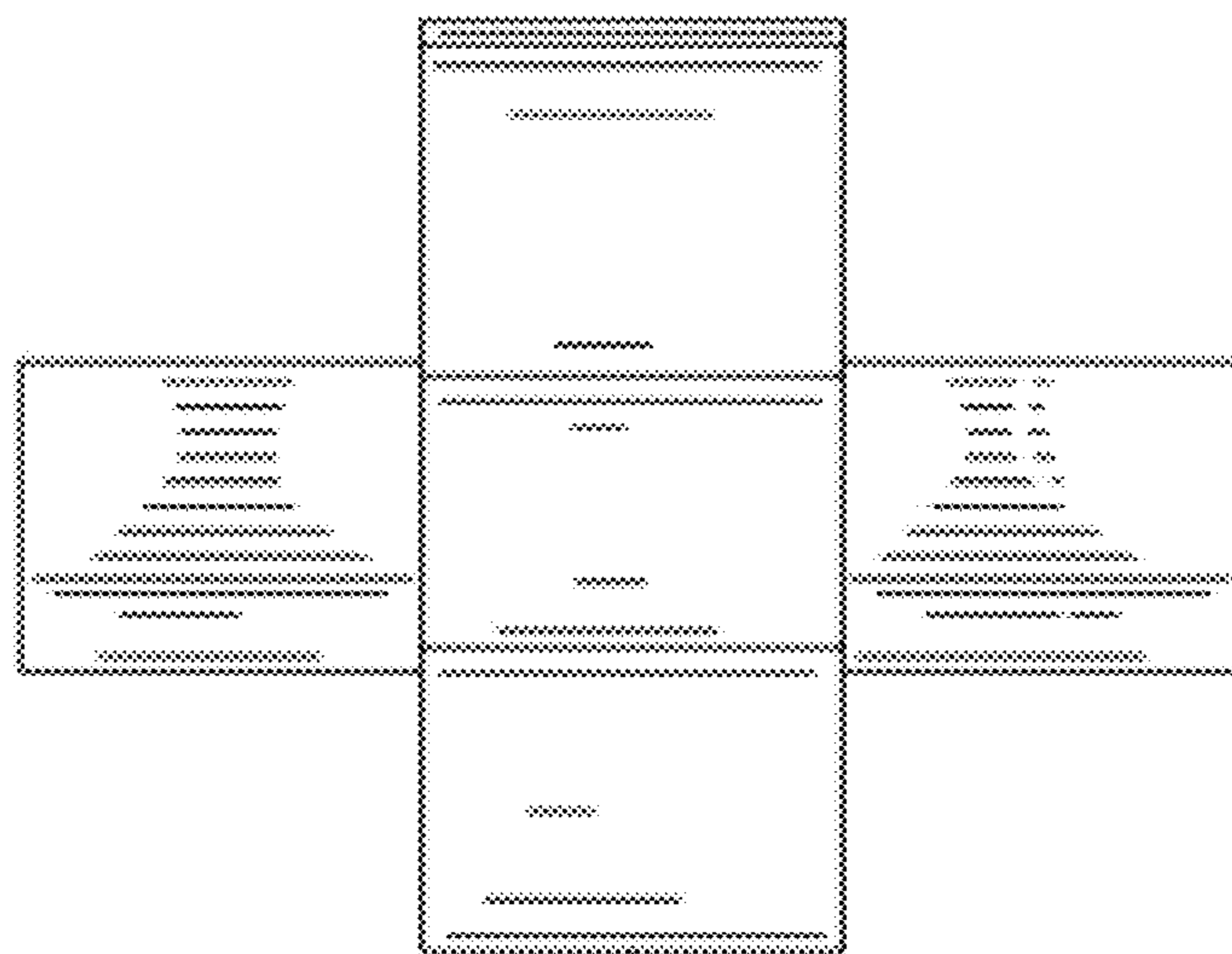

FIG. 7